



## KEY FEATURES

- High output Line Array element
- Compact size, very good output-to-weight ratio
- High quality, low compression, low distortion HF driver with Titanium Diaphragm and new suspension design
- Very stable horizontal coverage
- Transmission Line back loading for clean mid-bass reproduction and natural cardioid behavior
- Natural sound Transmission Line HF projection wave-forming device
- 96kHz / 40 bit floating point CORE processing with PRONET remote control
- Digitally controlled Class D amplifier module with SMPS

## APPLICATIONS

The AX2010A Vertical Line Array element is designed for a wide range of sound reinforcement applications where a flexible and easy to use vertical array systems is needed.

## TECHNICAL SPECIFICATIONS

### SYSTEM

System's Acoustic Principle	Line Array Element Short Transmission Line LF Back Loading Acoustic Transmission Line HF Waveguide
Frequency Response ( $\pm 3$ dB)	75 Hz – 18kHz (Processed)
Horizontal/ Vertical Coverage Angle	110° (-6dB) / 10° (-6dB)
Maximum Peak SPL @ 1m	138 dB

### TRANSDUCERS

LF	Two 10"(260mm), 2.5" (64mm) aluminum voice coil, 16 $\Omega$ each, paralleled
HF	Two 1.4" drivers, 2.5" (64mm) edgewound voice coil, titanium diaphragm, 16 $\Omega$ each, paralleled

### ELECTRICAL

Input Impedance	20 k $\Omega$ balanced, 10 k $\Omega$ unbalanced
Input Sensitivity	+4dBu / 1.25 V
Signal Processing	CORE processing, 96kHz / 40bit floating point SHARC DSP, 24 bit AD/DA converters
Direct access Controls	4 Presets (Standard/Long Throw/Down Fill-Single Box, User), Network Termination, GND Link
Remote Controls	PRONET control software
Network protocol	CANBUS
Amplifier Type	Class D with SMPS, Variable Switching Frequency
Output Power	1000W + 1000W
Mains Voltage Range (Vac)	230V $\pm$ 15% - 115 $\pm$ 15% 50/60Hz (internally selectable)
IN / OUT Connectors	Neutrik XLR-M / XLR-F
IN / OUT Network Connectors	ETHERCON®(NE8FAV)
Mains Connector	PowerCon® (NAC3MPA)
Mains Link Connector	PowerCon® (NAC3MPB)
Cooling	Variable speed DC fan

### ENCLOSURE & CONSTRUCTION

Physical Dimensions	
W x H x D	746 mm (29.37") x 341 mm (13.42") x 530 mm (20.86")
Enclosure Material	15mm, reinforced Phenolic Birch
Paint	High resistance, water based paint
Suspension system	
Front Suspension	Aluminum Fast Link structure
Back Suspension	High Strength Steel with 1/4 Fast Pin
Net Weight	40.3 Kg (88.70 lbs.)



## DESCRIPTION

The AX2010A is a new powered line array element that combines superior sound quality with easiness and flexibility in a simple system with a very convenient price-to-performance ratio.

The AX2010A has been designed both for rental live sound applications and for fixed installations and has been engineered for the simplest use possible but without sacrificing anything in sound quality and performance.

## TRANSDUCERS

The high frequency range is reproduced by two low-distortion compression drivers, equipped with very light-weight diaphragms. Two transmission line wave-forming waveguides have been used to load the HF drivers, in order to provide a detailed and natural sound and to achieve a long-distance HF projecting capacity.

The two 10" woofers employed in the reproduction of the mid-bass range are equipped with very light-weight cones. The lightness of the diaphragm is furthermore improved by the use of aluminum voice coil instead of conventional copper. This ensure a fast reproduction of the mid range and of mid-bass musical passages, improving also the thermal capacity of the voice coil and, consequently, controlling the overall power compression. The two 10" woofers are back loaded by a short hybrid transmission line that minimizes the effect of the box resonances and eliminates the "boxy" mid-bass sound commonly obtained from regular bass-reflex enclosures.

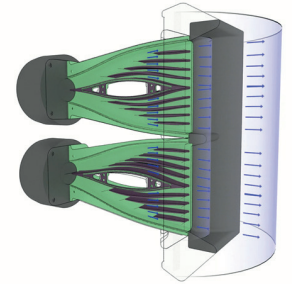

## SYSTEM CONCEPT AND SONIC PERFORMANCES

The AX2010A offers a simple but innovative design in line array elements. The simple concept of the WTW symmetrical design is implemented in an effective way in order to minimize the effects of potential beaming phenomena around the crossover frequency.

In order to minimize these effects, many different details have been carefully engineered, the first of them being the choice of the HF driver units. The special light-weight diaphragm used in these drivers features a very low mechanical resonance, thus allowing a relatively low crossover frequency point that is placed in the 900Hz range.

Moreover, the orientation of the two woofers allows to minimize the interference effect between them, while the use of a mechanical-acoustic polyurethane filter represents a further help in minimizing the midrange beaming.

The crossover filter approach is based on a "Constant Power" technique. Thanks to a particular phase combination between the two ways around the crossover frequency, this approach is able to provide a very stable horizontal coverage and a very stable off-axis sound image, also minimizing unwanted effects around the crossover frequency. The further application of phase linearization techniques, combined to constant power crossover, yield a linear phase response and a coherent time response. This allows for a natural perception of acoustic instruments and voices and for an improved depth of the sound image.

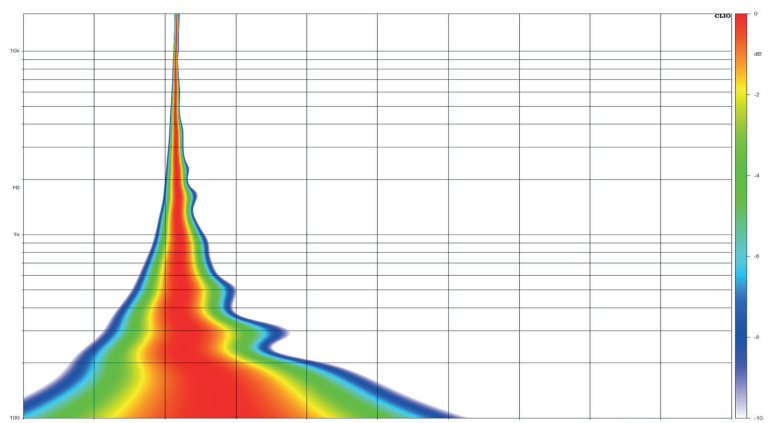
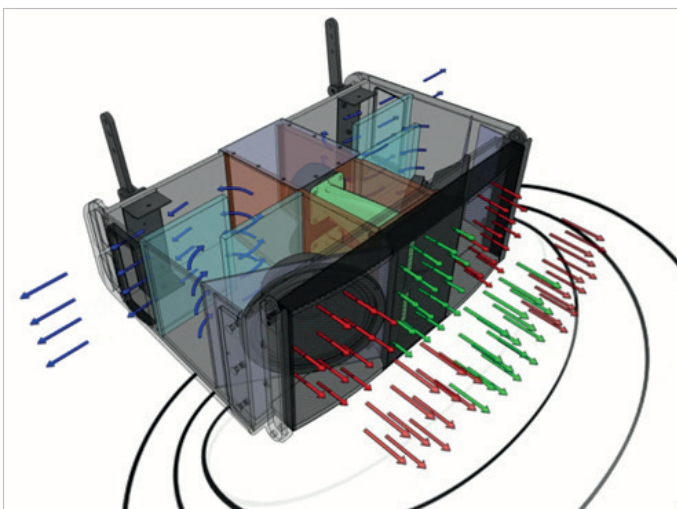

AX2010A time alignment

## SIGNAL PROCESSING and POWER AMPLIFIERS

The system processing is based on the **CORE DSP platform** designed by the PROEL R&D Laboratories using one of the most advanced SHARC DSP for audio application. It features 40bit, 96kHz floating point resolution and top-quality 24bit AD/DA converters, for a perfect signal integrity, a dynamic range in excess of 110dB and a superior sonic performance. Thanks to its massive processing power, the CORE platform is capable of providing the most sophisticated algorithms for speaker processing, together with remote control and networking capability.

The PRONET control software, working on a solid and reliable CANBUS based network protocol, provides an intuitive interface for the remote control of the whole system, with the possibility of eqing, delaying, increasing the protections and monitoring the status of the amplifier.

The AX2010A is powered by **DA SERIES** digital power modules, a new generation of CLASS D power amplifier with digitally-controlled SMPS. The innovative technology used for these amplifiers (including also the use of a variable switching frequency) offers performances at the top of the range, such as a superior sound definition at any audio frequency, very high dynamics also for low level signals and very low distortion even at the maximum power. The superior sound quality can be compared with top-of-the-range AB-class analog systems, while the DA modules feature a higher dynamics, very compact size and light weight and efficiency above 90%.

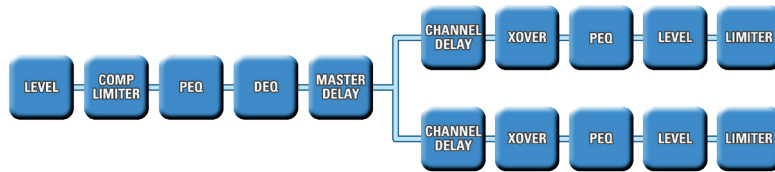
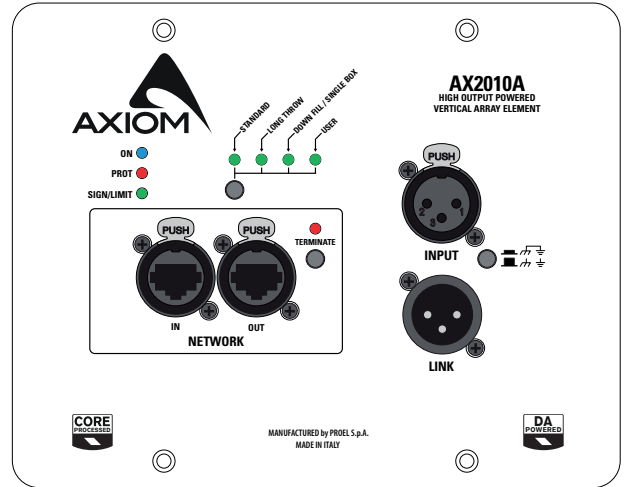

## HARDWARE

The AX2010A includes as an integral part of the cabinet a built-in FLYING HARDWARE that provides an easy and fast installation together with an excellent load-bearing capacity.

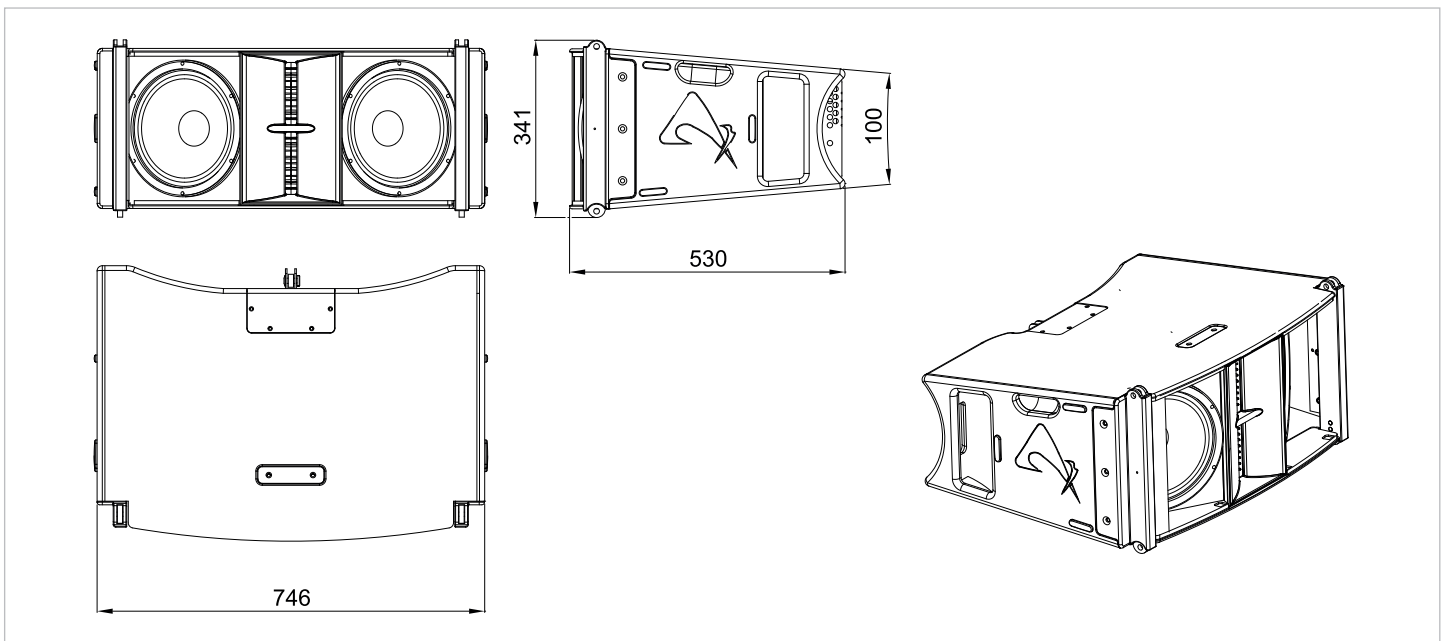

AX2010A frequency response with the 3 available PRESETS

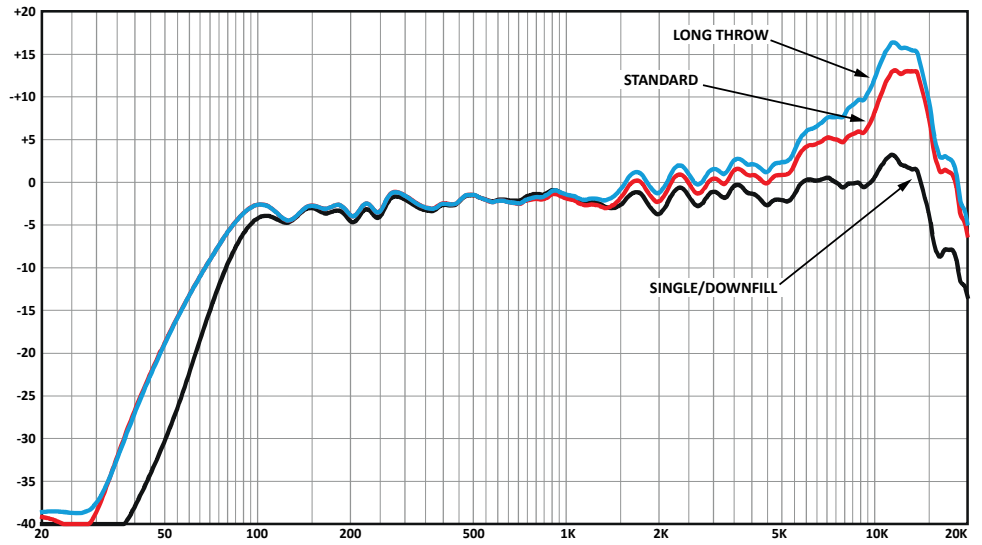

AX2010A HORIZONTAL directivity map

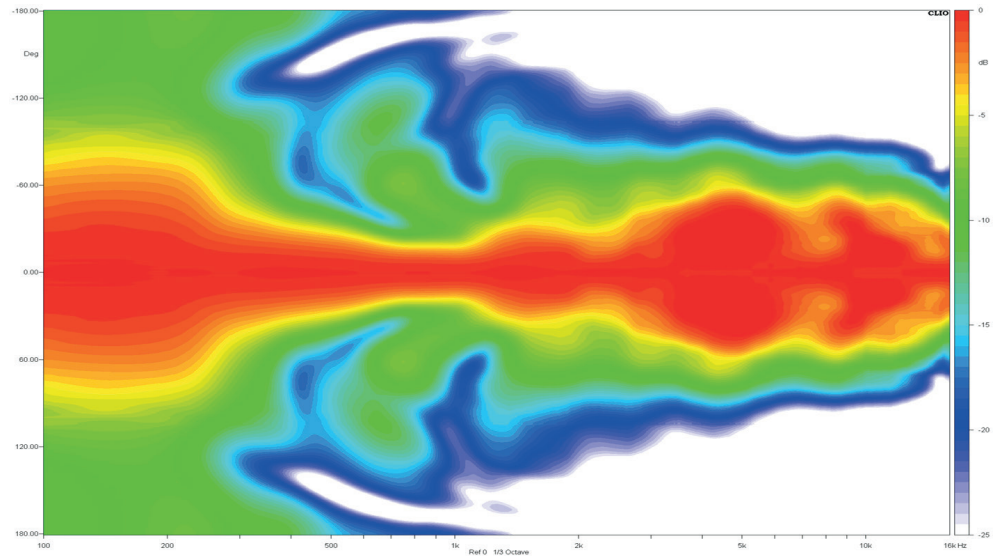

AX2010A VERTICAL directivity map

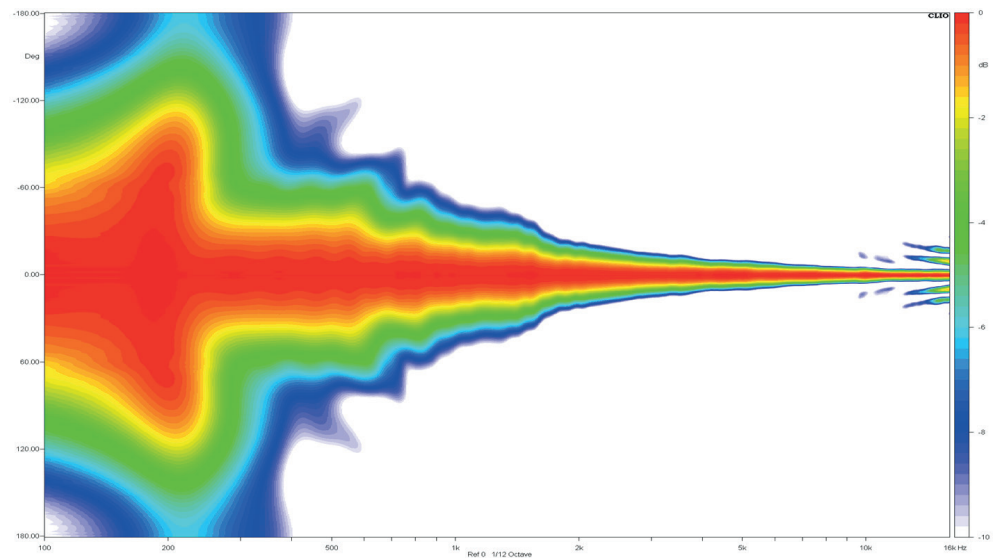

## AX2010A HF HORIZONTAL polar diagram

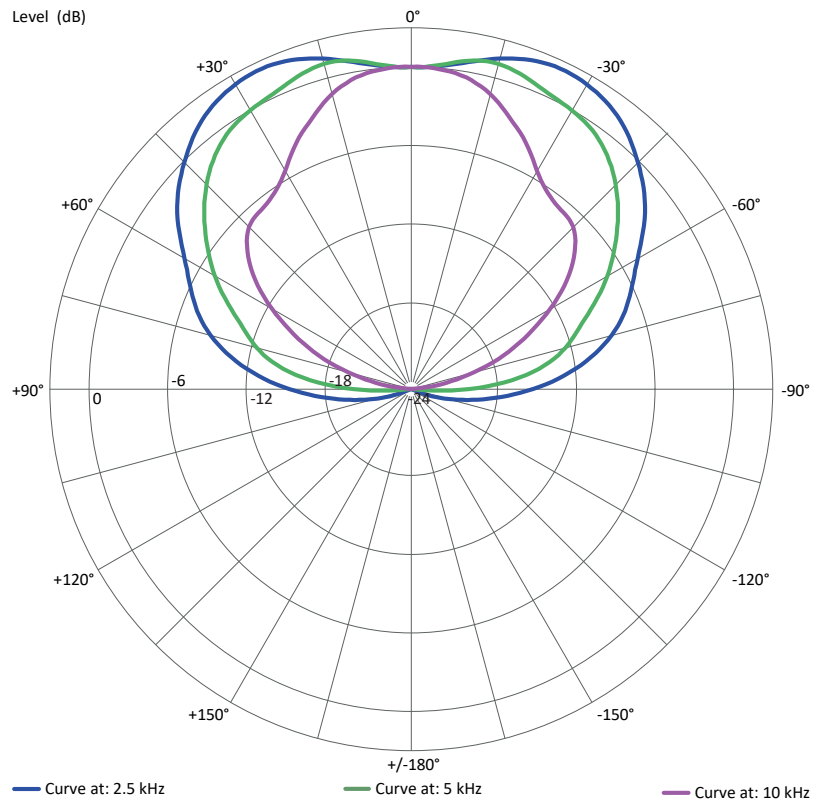

## AX2010A HF VERTICAL polar diagram

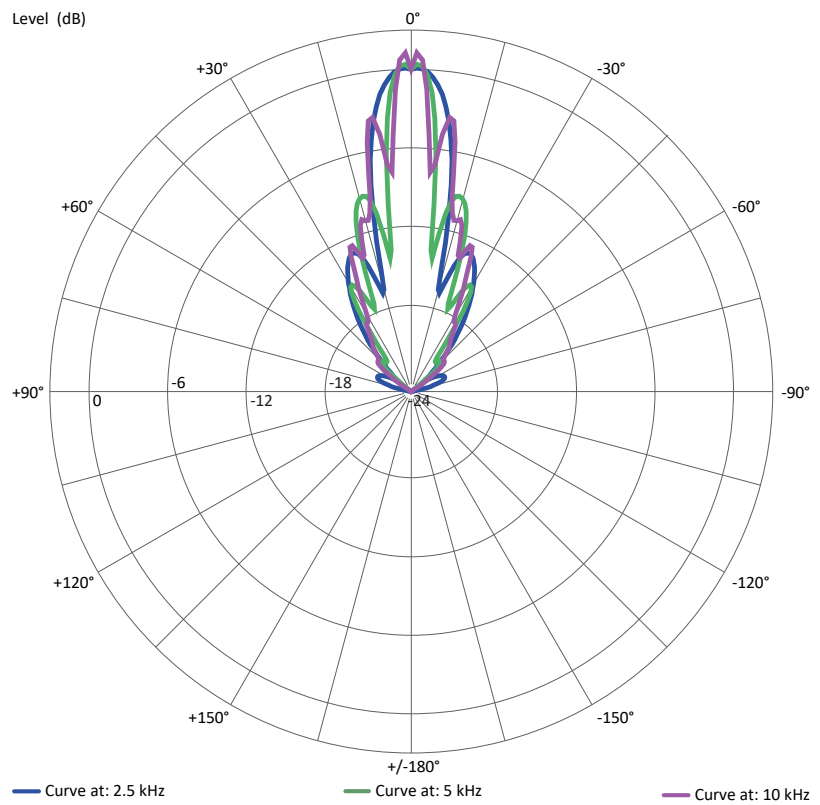

## AX2010A LF HORIZONTAL polar diagram

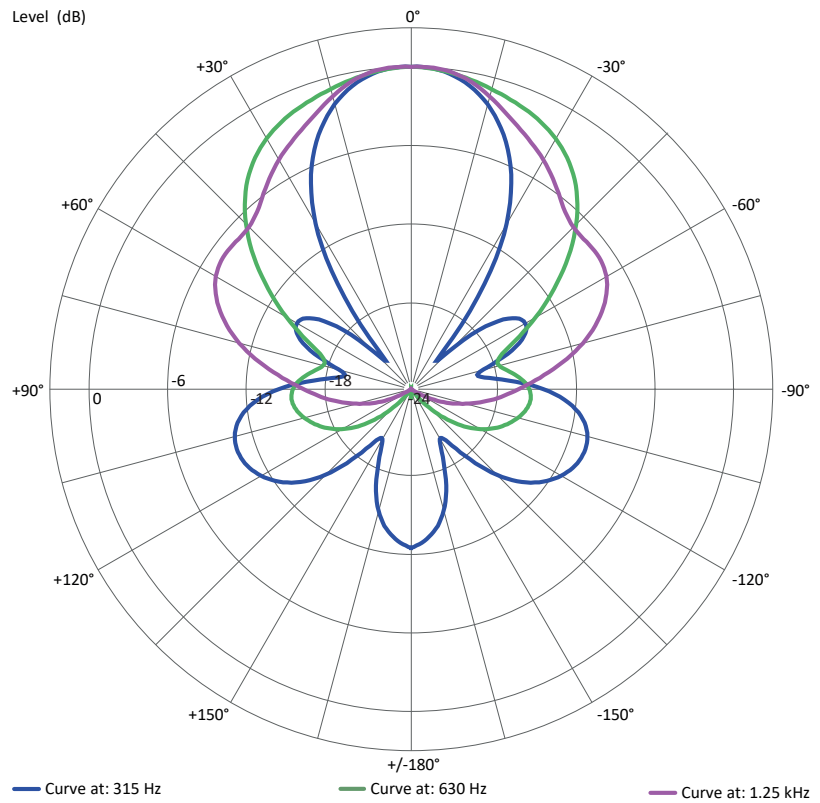

## AX2010A LF VERTICAL polar diagram

