

YOUR SOUND PARTNER

PRODUCT CATALOGUE



INDEX

The Essence of Sound	4
The Journey Starts Here	6
Design and Engineered in Italy	8
The Finest Italian Craftsmanship	10
Customisation	12
Support	14
Pronet AX	16
Technology	18

AX Line Arrays

• AX12C	22
• AX6C	24
• AX12LF	25
• AX16CL NEW	26
• AX8CL NEW	28
• AX4CL NEW	29
• AX1012A / AX1012P	30
• AX2010A / AX2010P	32
• AX2065A / AX2065P	34
• AX800A NEO NEW	36
• AX800A	40
• Technical Specifications	42

CX Stage Monitors

• CXL12A	48
• CX14A	49
• CX15A	50
• Technical Specifications	51

SW Subwoofers

• SW2100A / SW2100P	54
• SW212A NEW	56
• SW218XA / SW218XP	58
• SW36XFA / SW36XFP	60
• SW1800A	62
• SW215A / SW215P / SW215FA / SW215FP	63
• SW18A / SW18P	64
• SW210P	65
• Technical Specifications	66

ED Point Source

• ED150A / ED150P	72
• ED120A / ED120P	73
• ED80P / ED60P	74
• ED25P / ED23P MKII	75
• Technical Specifications	76

QC Power Amplifiers

• QC4.4 / QC2.4	78
-----------------	----

PC Series

• PC260	80
---------	----

Accessories	82
-------------	----



AXIOM



AXIOM

THE ESSENCE OF SOUND



The essence of Sound

AXIOM represents the culmination of an extensive development project that addresses the specific requirements of concert touring, fixed installation and portable sound reinforcement professionals around the world.

Combining state-of-the-art proprietary Italian-made transducers, advanced electronics and modern digital technologies in a range of high performance loudspeaker products designed and manufactured entirely in Italy, AXIOM utilises the most efficient production and test processes available to achieve incomparable quality and ultimate reliability.

The AXIOM product range provides a dedicated solution for every conceivable sound reinforcement application: as a main front of house PA system either indoor or outdoor; for stage monitoring and side fills; in fixed installations ranging from sports facilities to theatres, houses of worship, live music venues, nightclubs and bars; and for a myriad of corporate and portable applications.

AXIOM products are proudly supported by a specialised technical support network in more than 80 countries worldwide.



PROEL is a leader in the design, manufacture and distribution of audio, video and lighting equipment for the world of entertainment and live music events, and for fixed installations.

Established in 1991 by Fabrizio Sorbi in Sant’Omero, Italy, the company has witnessed steady development and robust growth. Today PROEL employs more than 120 people at its state-of-the-art modern factory, and distributes its products in over 120 countries worldwide.

The creation, in 1997, of the PROEL research and development team marked the beginning of a long and successful journey in the design and marketing of high quality sound reinforcement products. In 2002, after bringing on board technicians and professionals with years of experience in designing sound systems and their use in live applications, the R&D team embarked on the research of higher performance intelligent solutions for a global sound reinforcement market.

PROEL quickly assembled a group of specialists with expertise not only in academic and laboratory disciplines, but also behind mixing desks and on concert stages – and had created a Series of successful point source and line array loudspeaker systems rooted in technical innovation and originality.

In 2014 a specialist design team was assigned to the creation of a new AXIOM brand, with the specific aim of developing a comprehensive loudspeaker product range that fulfils the expectations of customers looking for top performance. The team embarked on the challenge of crystallising the requirements of professional users and translating these into innovative solutions that provide excellent sound quality, ease of use, versatility and reliability.

Today the AXIOM team – made up of loudspeaker system designers, analogue electronics specialists, digital systems practitioners, integration experts and live sound engineers – is creating the most advanced, state-of-the-art technologies: using powerful ultra-light transducers, efficient class-D amplifiers, integrated digital signal processors, high-end analogue electronics and convenient, efficient wiring and suspension systems.



**THE JOURNEY
STARTS HERE**

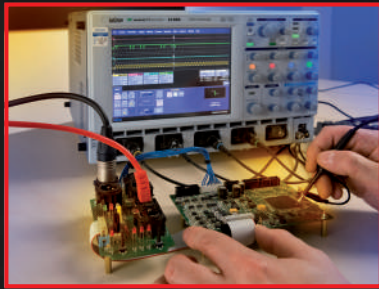

State-of-the-art analogue and digital
electronic design



Advanced 3D modelling and
mechanical engineering

DESIGNED AND ENGINEERED INITALY

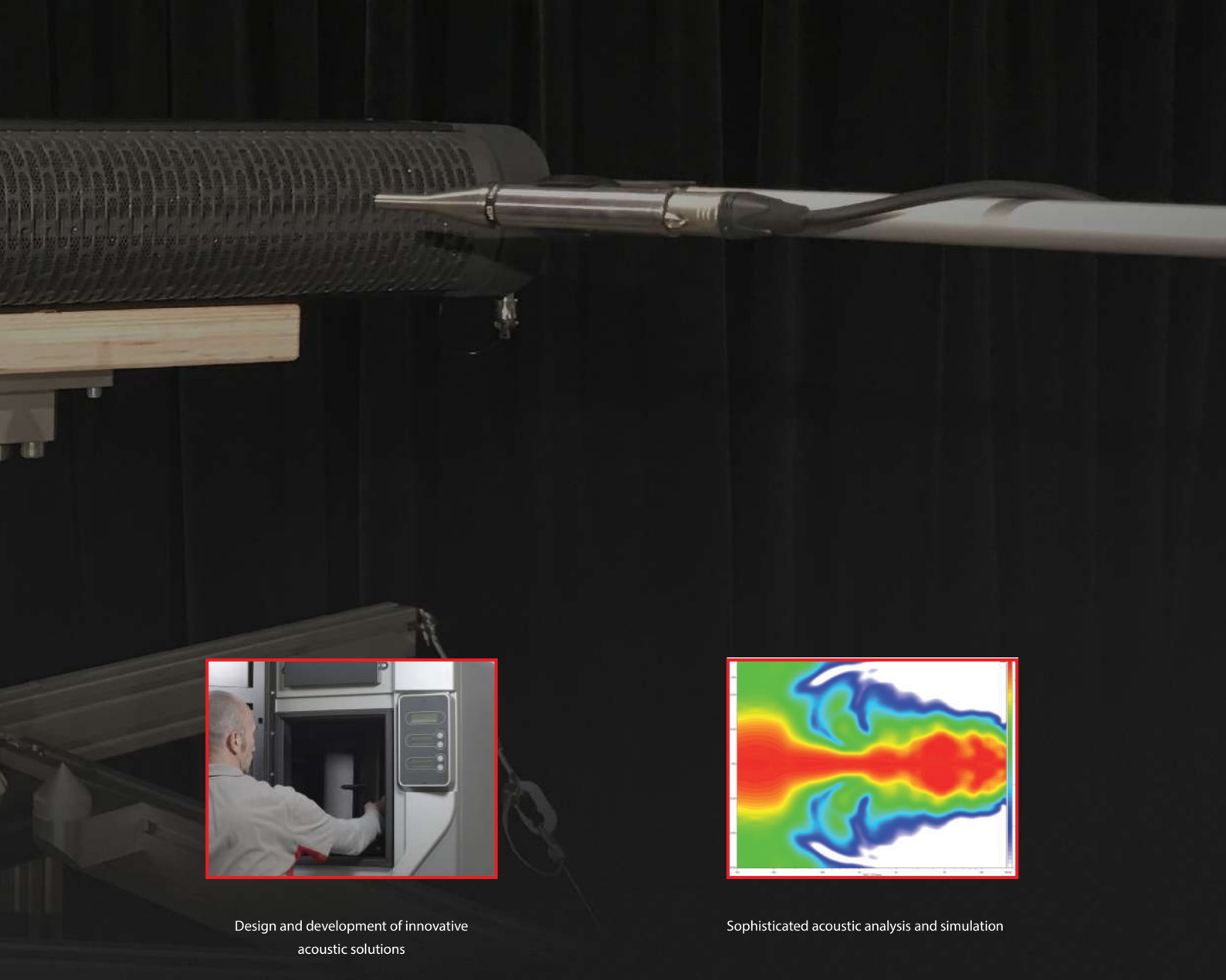

Design and development of innovative acoustic solutions

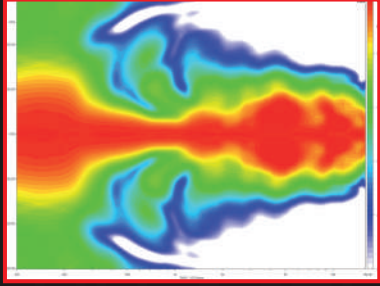

Sophisticated acoustic analysis and simulation

Skilful design and the application of appropriate technology in combination make a great product, working together for the most optimal form and function to be achieved. AXIOM loudspeaker systems are uniquely designed and engineered entirely in Italy by the AXIOM R&D team and manufactured at the new PROEL production hub in Acquaviva. This new facility provides the AXIOM brand with modern production processes, high quality standards, huge logistics spaces and an efficient layout, staffed by highly qualified design engineers, digital electronics experts, and technicians.

The PROEL lab enables the R&D team to seek out new technological solutions through its strong links with local and national academic institutions, to constantly optimise products in the current portfolio, and to design and bring to market products tailored to the needs of professional users that make a lasting impression on the sound reinforcement market.

The AXIOM range was developed using the most advanced 2D and 3D modeling software, renowned for the ability to visualize and generate complex waveguides and for its accuracy in designing with many different materials. These processes have been combined with high end industrial design to create refined loudspeaker systems with real world applications.

We have developed sophisticated analytical and measurement routines that evaluate every minute aspect of the loudspeaker components' acoustical, mechanical, and thermal behaviour to ensure that predictably repeatable performance and effective manufacturability can be maintained within tight tolerance limits.

Development of the acoustic domain is of course only part of the story. Digital electronics has literally transformed the way that professional sound systems can perform in widely variable venue conditions, not to mention the convenience of packaging lightweight amplifiers together with digital signal processing modules within the loudspeakers themselves. The AXIOM R&D team has attached great importance to the field of digital electronics and has developed proprietary DSP platforms for speaker processing and audio signal distribution that are amongst the highest quality available.

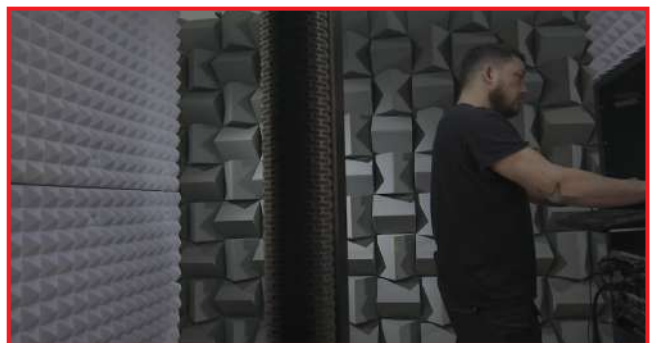
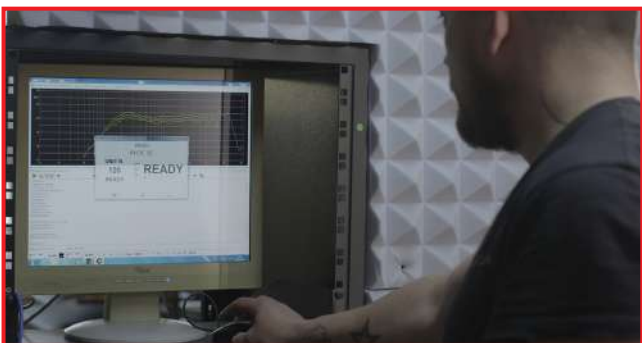



THE FINEST ITALIAN CRAFTSMANSHIP

AXIOM products are manufactured entirely in-house at PROEL's ultra-modern factory in Acquaviva, Italy. This means that every aspect of the process from the cabinet construction to the immaculately finished product is managed and controlled under the most careful supervision – and while an artisanal philosophy is embraced with an emphasis on a highly skilled workforce, modern quality control standards to ISO9000/2008 are adopted.

Baltic birch plywood, manufactured using phenolic water-resistant adhesives, is used on all AXIOM speakers. Cutting and routing is handled by state-of-the-art CNC machines on a flexible macro scale which allows for rapid response to changing product demands, maintains highly efficient computer-generated material yield, and can even be used for prototyping purposes. Enclosures are finished either in low allergen content water-based paints or polyurethane paint under temperature and pressure controlled conditions, and custom colours are offered for easy product customisation.

All the compression drivers and cone transducers used in AXIOM are manufactured in Italy by well-known and respected driver makers, considered to be the undisputed leaders in their field. A fully automated CLIO measurement system ensures that every AXIOM product that leaves the factory meets precise technical specifications within tight tolerance limits, and most importantly has passed several critical listening tests.

WHITE COLOUR OPTION

As an alternative to the standard black cabinet finish, that is designed to be discreet in the vast majority of installed and live sound applications and is supplied on all our plywood-construction loudspeakers, we also make some models available in a white textured paint finish (RAL 9010)



AX SERIES	SW SERIES	ED SERIES	FLYING BAR FOR AX SERIES	WALL BRACKET FOR ED SERIES
AX12CWH	SW210PWH	ED120PWH	KPTAX2012PWH	KPTED120WH
AX12LFWH	SW215FAWH	ED150PWH	KPTAX2065WH	KPTED150WH
AX1012PWH	SW215FPWH	ED23PWH	KPTSW215WH	KPTED23WH
AX2010AWH	SW36XFAWH	ED25PWH	KPTSW36XFWH	KPTED25WH
AX2010PWH	SW36XFPWH	ED60PWH	-	KPTED60WH
AX2065AWH	SW2100AWH	ED80PWH	-	KPTED80WH
AX2065PWH	SW2100PWH	-	-	-
AX6CWH	-	-	-	-

CUSTOMISED SOLUTIONS

For installation projects with particular custom requirements we can offer, in addition to the various colour options mentioned here, certain mechanical customisation options such as load-rated integral rigging, alternative connectors, and higher IP ratings including weather-resistant finishes, silicon treatments, rust-resistant metal parts, and sealed cable entry glands.

For these special requirements our in-house manufacturing facilities offer real flexibility to ensure that our loudspeaker systems are fit for purpose and for your project. Please contact our sales department or consult our price lists for specifics of these optional services.

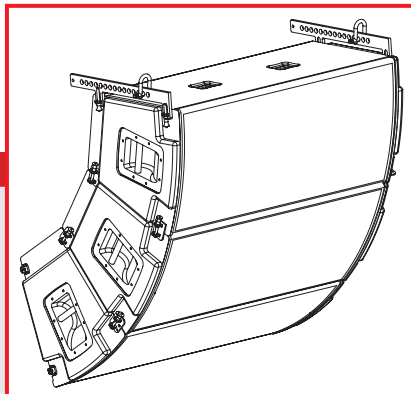

CUSTOMISED RIGGING SOLUTIONS

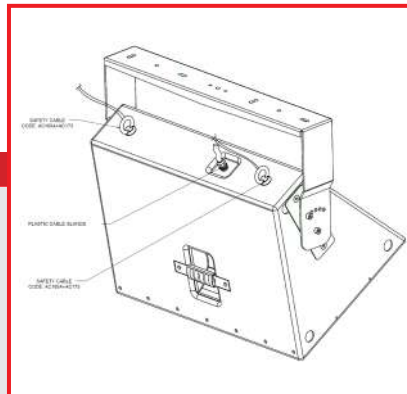

SEALED CABLE ENTRY GLANDS



CUSTOMISED CONNECTORS

COLOUR CUSTOMISATION

Custom colours according to specific RAL codes are available on request, that allow the speakers to blend in well with architect-designed projects and especially those venues with predominantly lighter colours.

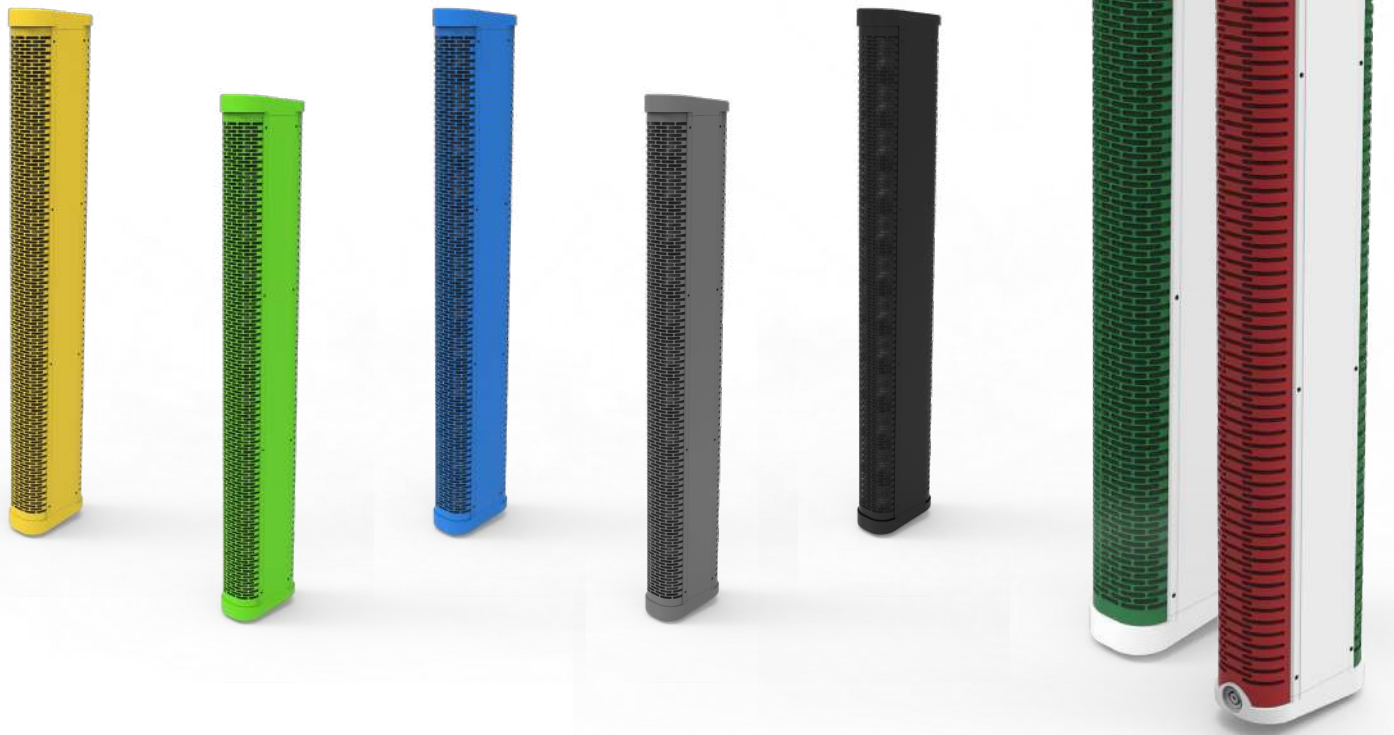

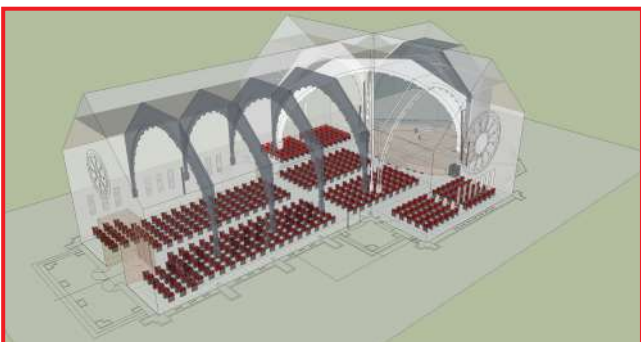
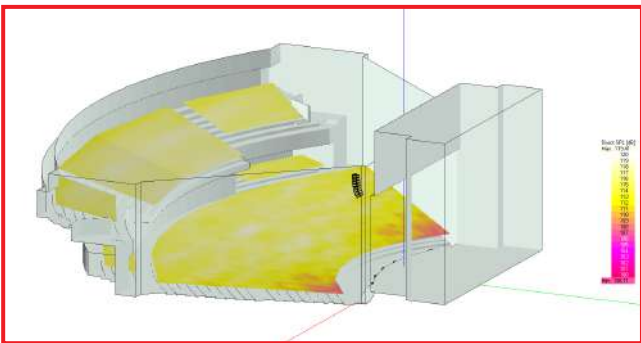
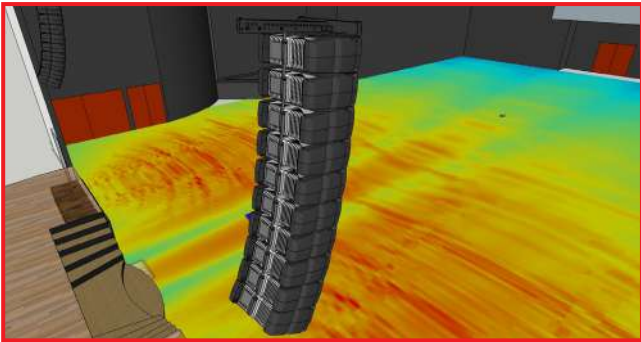
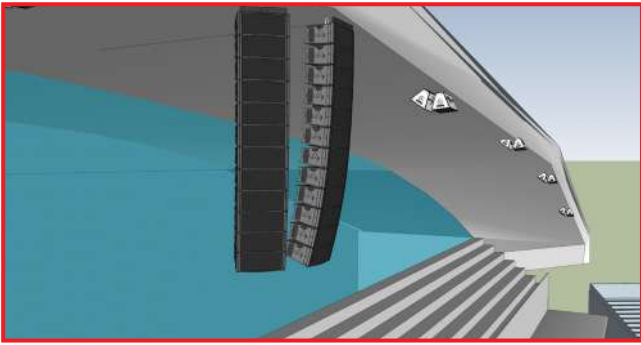
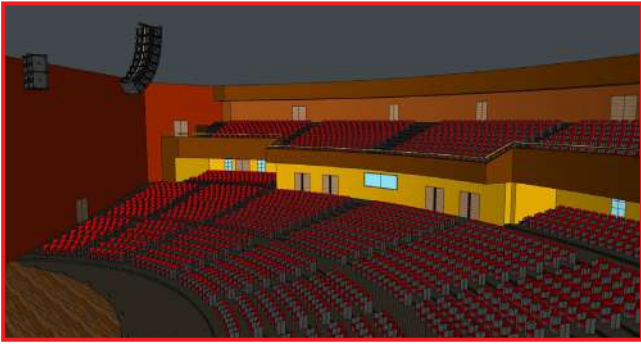

SUPPORT



AXIOM application engineers are working at your side.

We offer a qualified support to help you achieve the best results, win projects and gain market share.

Our job is to create a set of tools that you, as a partner, can offer to your customers: that's why we assist you in the planning and in the implementation of AXIOM technologies in your projects, and help you in providing 3D drawings, acoustic predictions and wiring diagrams, made by using market-leading software.

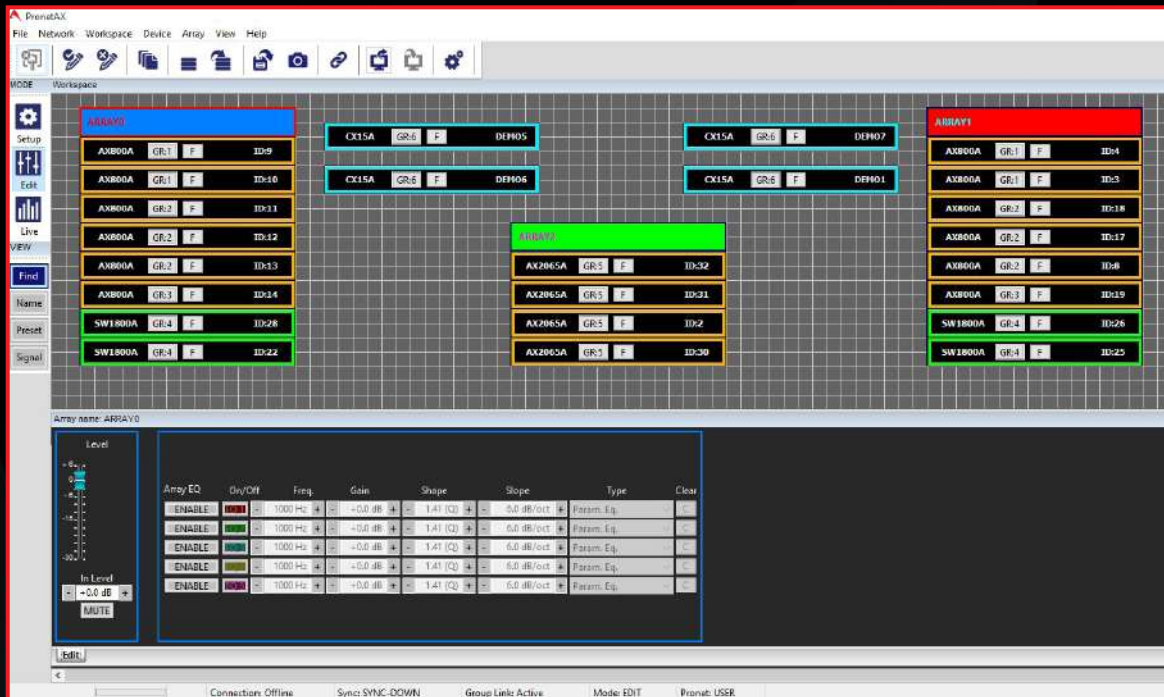

PRONET



LOUDSPEAKER CONTROL SOFTWARE

PRONET AX is the latest iteration of the widely-used PRONET remote control software, developed by PROEL's design engineers to control network-enabled AXIOM powered loudspeaker systems and power amplifiers equipped with the CORE DSP platform.

The PRONET AX software offers a totally redesigned user interface with improved object identification and management – thanks to color-coded items, intuitive icons and panels, desktop grid and docking Editor Panel.

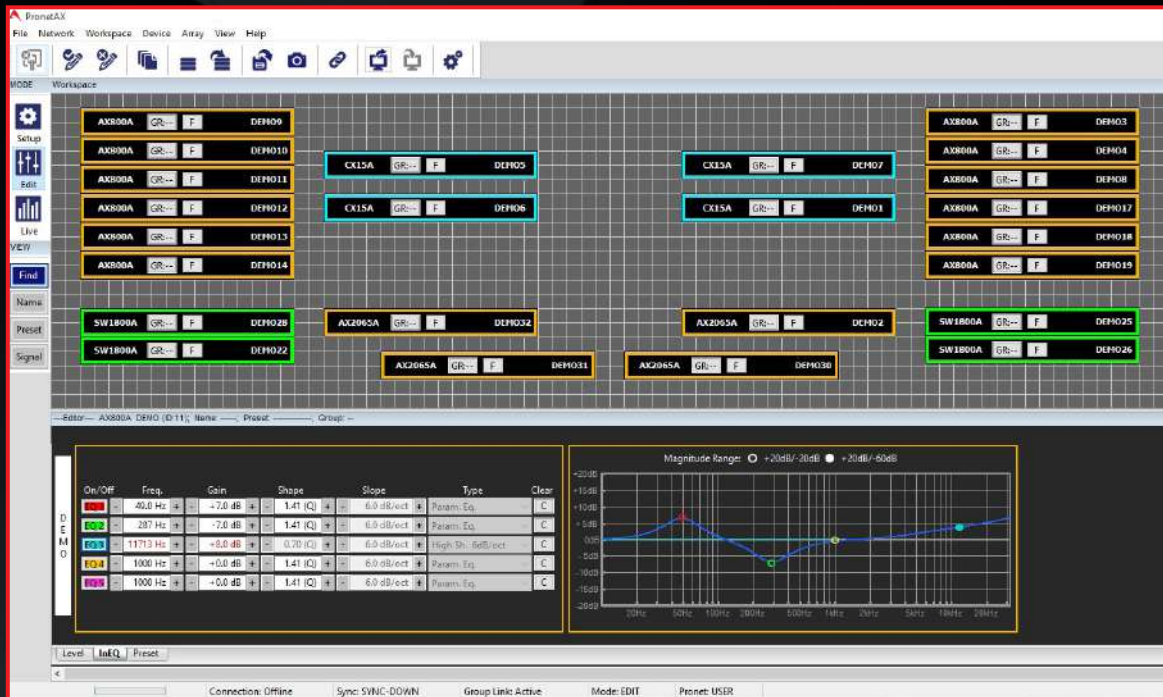

Three different operating modes are provided: SETUP, EDIT, and LIVE; these can be chosen depending on whether systems are to be set up for the first time, units are to be edited individually, or operated under live conditions; and on the operations to be performed on the loudspeaker system.

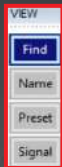

The interface allows different choices of information or features to be displayed or selected on the unit's control panels (for example Find / Name / Preset / Signal) and provides a method of fast Group assignment.



The software allows the easy creation of arrays of different models of AXIOM loudspeakers, and global control of volume, mute and EQ functions for each array.



Snapshots of the system can be loaded or saved, including a specific unit's position on the desktop and all the parameters of the whole system.



PRONET AX features a desktop-based operating mode known as SYNC DOWN, which provides the possibility to edit systems offline and download parameters to the connected units when going online.



The possibility to read the parameters from the connected system is maintained with the READ UP mode.

TECHNOLOGY

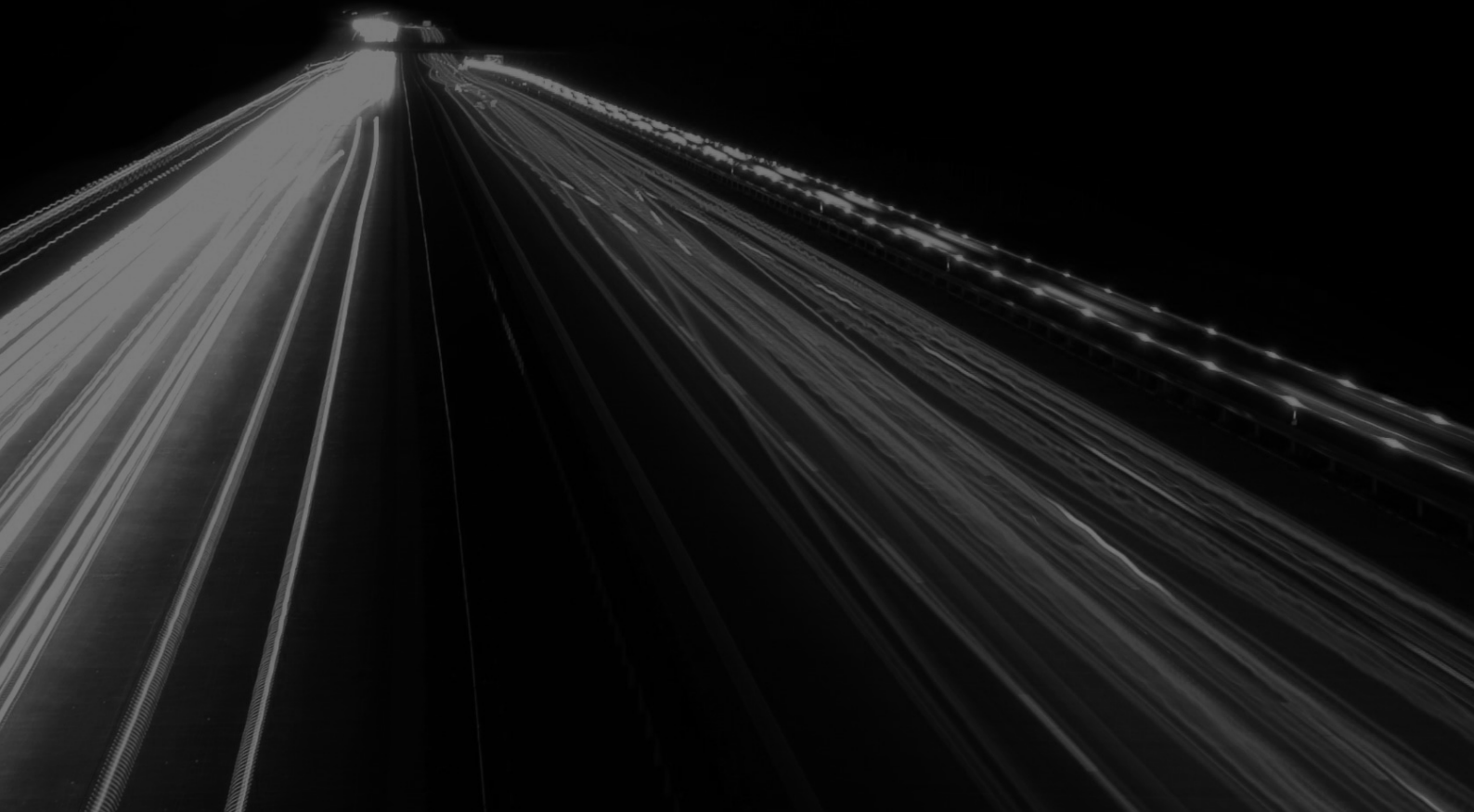



Acoustic Transmission Line back loading delivers natural cardioid behavior and clean mid-bass reproduction for a useful reduction of low frequencies at the rear of the array – creating a much cleaner soundscape on the stage and a reduced interaction with unwonted back wall reflections.

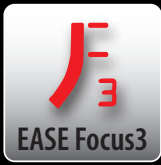

AXIOM supports EASE Focus 3 software platform to properly aim each line array system and make advanced acoustic simulations. GLL files are available as a free download from the Axiom website. EASE® is a registered trademark of AFMG Technologies GmbH.

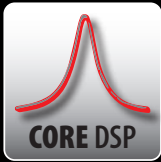

System processing is based on the CORE DSP platform developed by PROEL's R&D laboratories, using SHARC DSP. 40-bit, 96kHz floating point resolution and top quality A-D converters ensure perfect signal integrity and dynamic range in excess of 110 dB.



Finite impulse response filters whose impulse responses are of finite duration, because they settles to zero in finite time. FIR filters can achieve linear phase response and pass a signal without any phase distortion.



PRONET AX is a free software that works on the very stable and reliable CANBUS protocol and provides an intuitive user interface for the remote control of the whole system, offering access to equalisation, multiple delays, drivers protection and amplifiers status monitoring.



Class D amplifier modules with SMPS (Switch Mode Power Supply). The power supply employs a switching frequency that varies with input level, to deliver audio performance comparable to audiophile Class AB designs but with vastly improved efficiency (better than 90%) as well as much lower weight and reduced size.



Power-factor correction increases the power factor of a load, improving efficiency of the amplifier power supply. The amplifier power output will not change with mains swinging because the power supply regulates itself when AC mains change.

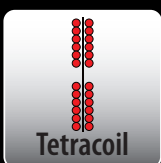

Tetracoil (TTC) is a blend of Eighteen Sound technologies representing the state of the art in the design of Dual Gap technology, where two voice coils wounded inside and outside the former are suspended evenly in the two magnetic gaps. This approach results in increased Power Handling, very low Power Compression and extremely reduced distortion thanks to the inherent Motor Symmetry.

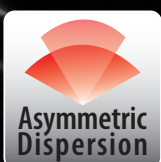

Asymmetric Dispersion consists in a variation of the horizontal coverage polar pattern which is wider in the lower part of the horn, for a more effective near field coverage, and narrower at the top of the horn, for a more focused coverage in the far field. The result is a more accurate coverage of a typical venue than is possible with a fixed horizontal coverage device.



GLL - AXIOM System definition files for EASE 4.4, the Industry Standard for Acoustical Simulation of Rooms and open areas. These data can be used to generate simulation of reverberation times, speech intelligibility and other acoustical parameters. EASE® is a registered trademark of AFMG Technologies GmbH.



AX LINE ARRAYS

KEY FEATURES

- High output line array elements
- Compact size, very good output-to-weight ratio
- High quality, low compression, low distortion HF drivers with titanium diaphragms and new suspension design
- Very stable horizontal coverage
- Transmission Line back-loading for clean mid-bass reproduction and natural cardioid behaviour
- Natural sounding Transmission Line HF projection wave-forming devices
- Front Diffraction Waveguides
- 96KHz / 40 bit floating point CORE processing with PRONET AX remote control
- Digitally controlled Class D amplifier modules with SMPS

AX Vertical Line Array systems are designed for indoor and outdoor sound reinforcement applications where flexibility and ease of use are a primary consideration. They combine superior sound quality with leading-edge processing and digital amplification in practical road-ready packages. Made entirely in Italy using world-renowned Italian transducers and state-of-the-art manufacturing techniques, the AX Series has been engineered for consistently reliable performance without compromise.

AX12C

12 x 3,5" High Output Column Array

AX12CWH • white version

The AX12C Line Array is a passive system equipped with twelve 3.5" neodymium transducers with waterproof cones, designed for portable and permanently installed applications where high power and clarity are needed.



The Front Diffraction Waveguide (FDW) delivers wide and stable horizontal 100° dispersion.



The construction techniques is based on Aluminium frame structure with integrated Fast and easy-to-use suspension system, making AX12C an effective Touring Grade solution.



AX12C column can be flown using the KPTAX12C flybar, making it an effective Touring Grade solution. It can also be combined with the AX6C in height-restricted spaces.



The integrated suspension system makes its deployment very fast and simple even in installed applications.

The AX12C line array module has been designed to be combined with the SW2100A, a compact and lightweight 21" subwoofer, equipped with a 4000W Class D amplifier, CORE DSP which can be remotely controlled by PRONET AX software, making it the perfect solution for high-performance portable sound reinforcement applications.

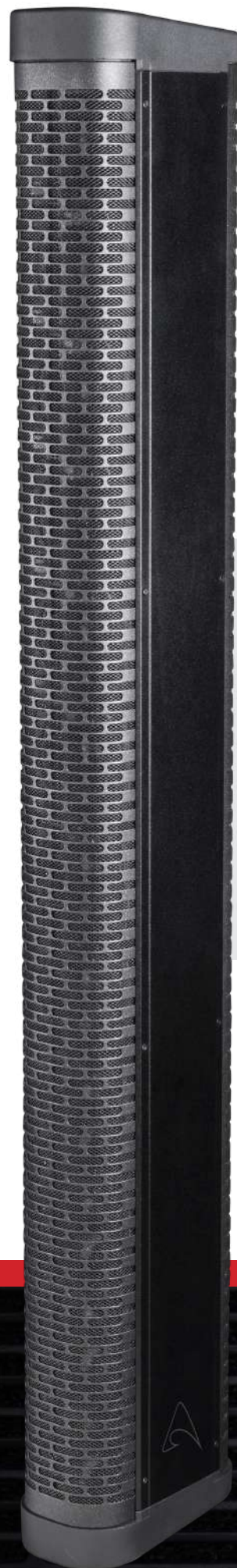



The Transmission Line back-loading technique solves a problem that can occur in many sound reinforcement situations - a perception of excessive bass and mid-bass frequencies behind the PA, and also on the stage.

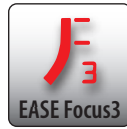

By directing radiation from the back of the speaker cones out of phase with the radiation from the front of the speaker cones, Transmission Line back-loading effectively cancels some of the low frequency energy behind the speaker array, maintaining an equivalent balance between the PA and monitors.

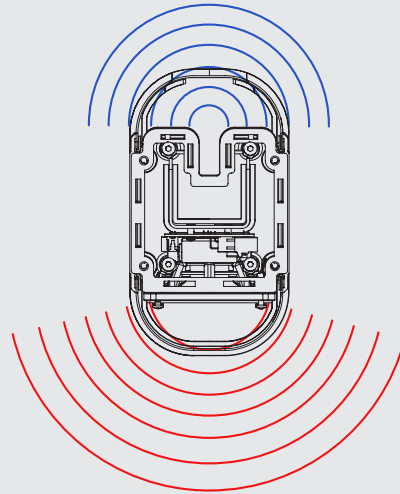

The result is a useful reduction in low range frequencies at the rear of the array – creating a much cleaner soundscape on the stage, and better separation between instruments in the mix.

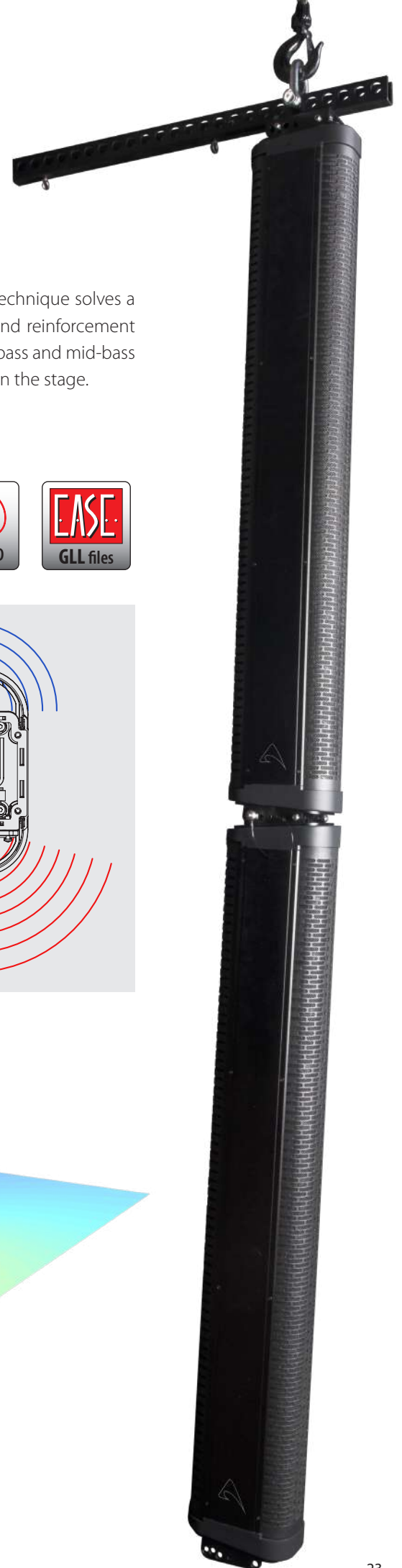
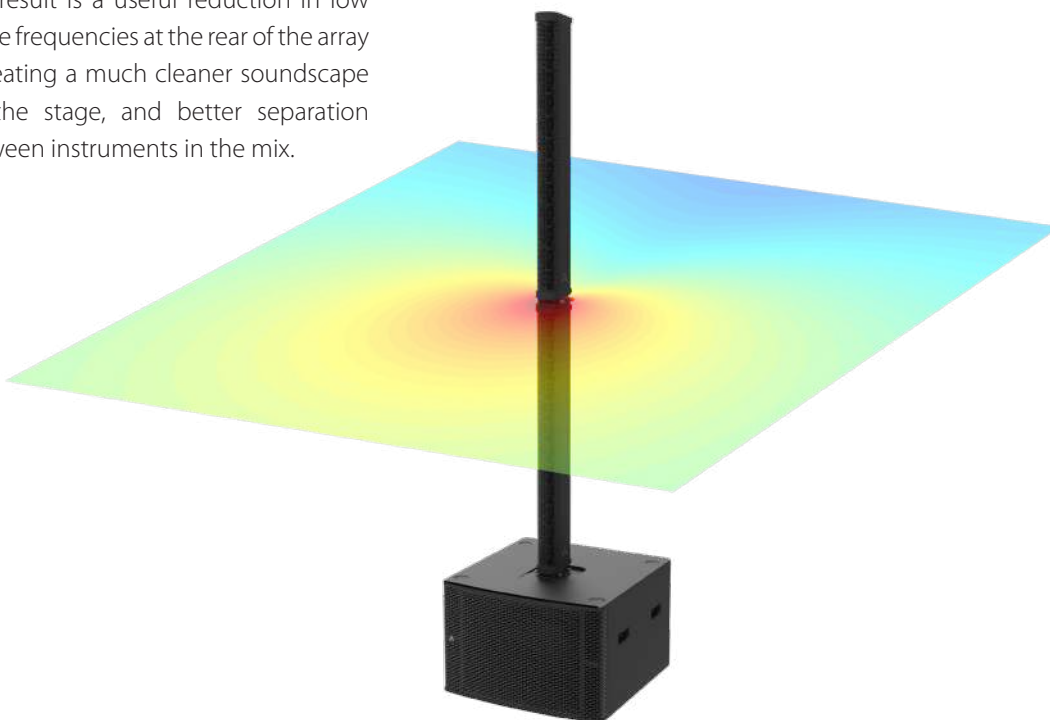

AX6C

6 x 3,5" High Output Column Array

AX6CWH • white version

Sharing the same attributes as the larger AX12C column array in a half-height enclosure. It consists of six 3.5", it can be combined with AX12C and AX12LF columns in multiple column systems in various configurations to match the physical space available. The AX6C can be powered using QC Series Class D amplifiers, which provide multiple presets for various combinations using the built-in CORE DSP which can be remotely controlled using PRONET AX software.

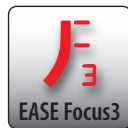

KPTPOLEAX12C
Pole Adapter

KPTWAX6C

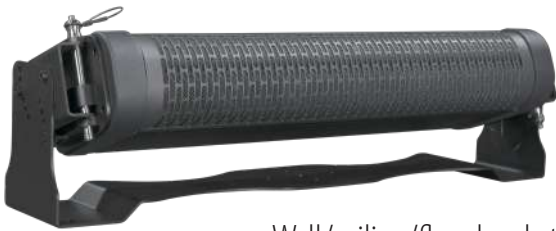

Wall/ceiling/floor bracket

KPTFAXC



Foam floor stand



AX12LF

12 x 3,5" High Output Low frequency Column Array

AX12LFWH • white version

The AX12LF line array is a passive low frequency loudspeaker equipped with twelve 3.5" long-excursion transducers designed to provide extended low frequency response for AX12C and AX6C columns. Wherever an external subwoofer is not needed or cannot be accommodated due to space restrictions, such as in speech applications or corporate events, the AX12LF provides an additional octave of frequency response down to 90Hz in the same width enclosure. Its common suspension system enables perfect integration with Axiom column array elements, either flown or ground supported. The AX12LF can be powered using QC Series Class D amplifiers, which provide multiple presets for various combinations using the built-in CORE DSP which can be remotely controlled using PRONET AX software.



AX6C

AX12LF

KPTFAX12C
Floor Stand with 4 legs

AX16CL

New

16 x 2.5" High Output – Tour Grade - Slim Column Array

AX16CLCWH • white version

The AX16CL is a slim Column Array equipped with sixteen 2.5" Hi-Fi full range transducers, designed for portable and permanently installed applications that require both functionality and a sense of design. A combination of stylish design and outstanding performance features makes AX16CL ideal for Live Sound applications and for installations such as auditoriums, conference rooms, House of Worship, fill applications, audio for video, and all applications where slim, compact design and high performance is desired.



Sixteen Hi-Fi 2.5" transducers cones provide a wide horizontal and narrow vertical coverage which produce consistent sound levels from the front to the back of the listening area, without having to use bulky multiple speaker cabinets.



The integrated suspension system makes its deployment very fast and simple even in installed applications. allowing to make elegant sound systems that respect the design of rooms and scenography.



The aluminum frame box structure ensures lightweight, strength but allowed also to achieve an original design and an unique performance-to-size ratio.

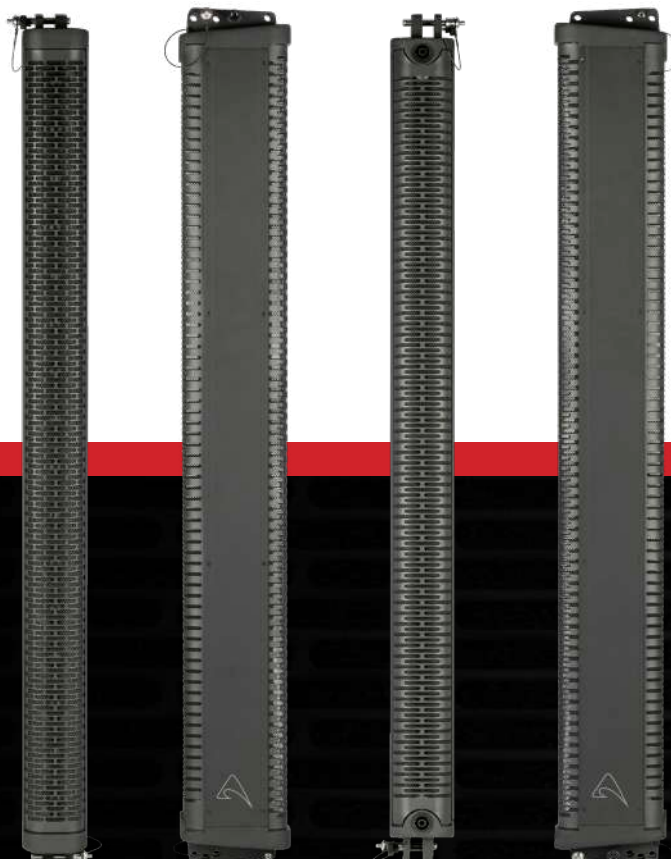

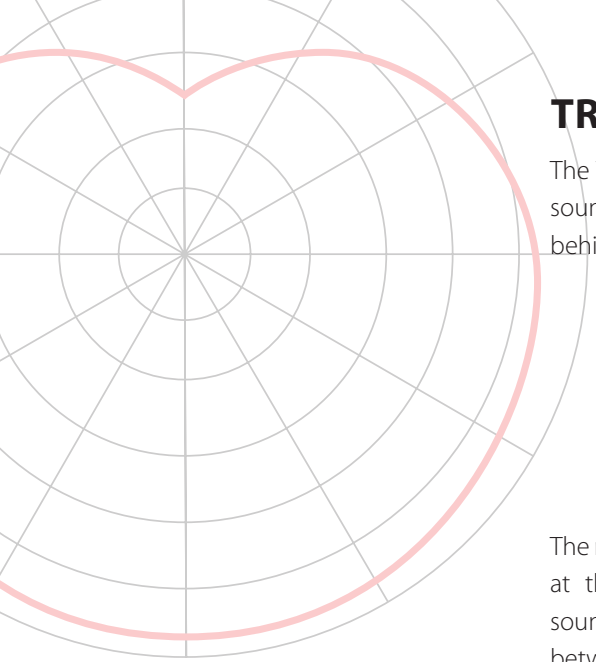

TRANSMISSION LINE BACK-LOADING

The Transmission Line back-loading technique solves a problem that can occur in many sound reinforcement situations - a perception of excessive bass and mid-bass frequencies behind the PA, and on the stage.

The result is a useful reduction in low range frequencies at the rear of the array, creating a much cleaner soundscape on the stage, and better separation between instruments in the mix.

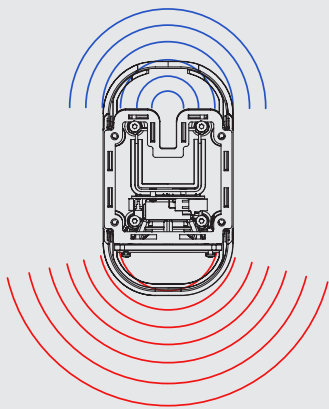

By directing radiation from the back of the speaker cones out of phase with the radiation from the front of the speaker cones, Transmission Line back-loading effectively cancels some of the low frequency energy behind the speaker array, maintaining an equivalent balance between the PA and monitors.

SET IT UP IN NO TIME AT ALL

The AX16CL Column Array has been designed to be combined with the SW212A, a compact and lightweight dual 12" subwoofer, equipped with a 1400W + 1400W Class D amplifier, CORE DSP which can be remotely controlled by PRONET AX software, making it the perfect solution for high-performance portable sound reinforcement applications.

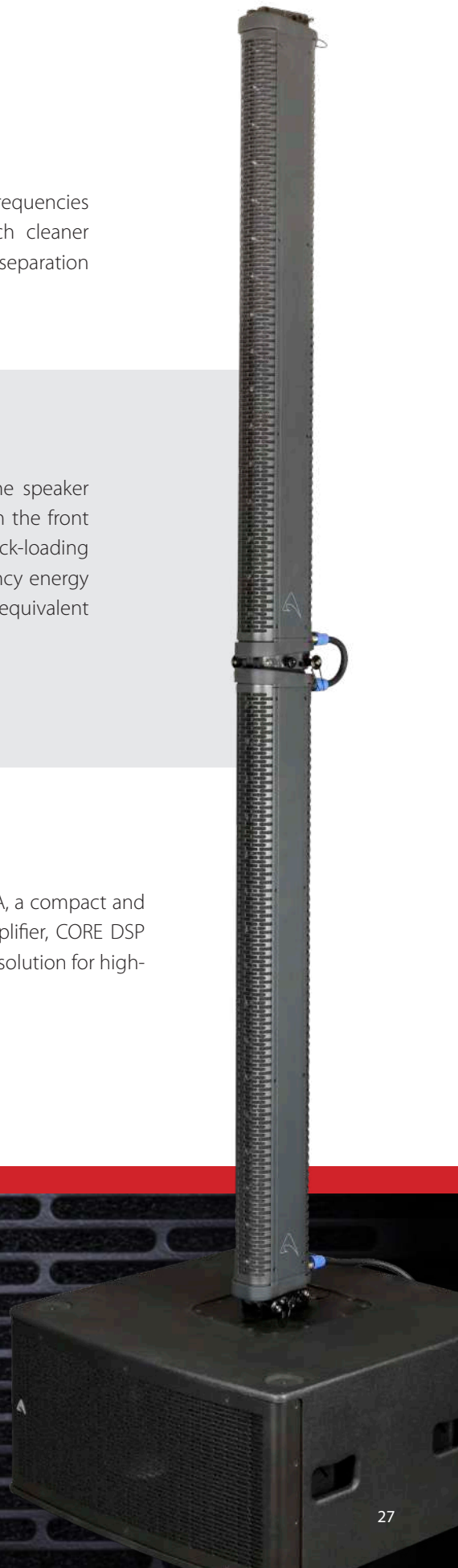

AX8CL

New

8 x 2.5" High Output – Tour Grade - Slim Column Array

AX8CLWH • white version

AX8CL consists of eight 2.5" transducers, sharing the same attributes as the larger AX16CL column array in a half-height enclosure, it can be combined with AX16CL in multiple column systems in various configurations to match the physical space and desired throw distances.

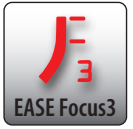

Sixteen Hi-Fi 2.5" transducers cones provide a wide horizontal and narrow vertical coverage which produce consistent sound levels from the front to the back of the listening area, without having to use bulky multiple speaker cabinets.



The integrated suspension system makes its deployment very fast and simple even in installed applications. allowing to make elegant sound systems that respect the design of rooms and scenography.



The aluminum frame box structure ensures lightweight, strength but allowed also to achieve an original design and an unique performance-to-size ratio.



AX4CL

New



4 x 2.5" High Output – Tour Grade - Slim Column Array

AX4CLWH • white version

AX4CL consists of four 2.5" transducers, sharing the same attributes as the two larger AX16CL and AX8CL column arrays, but unlike them it is intended to be used as a stand-alone loudspeaker in fixed or mobile installations, front-fill applications and low-profile stage monitoring solutions.

Thanks to its elegant mechanical design the AX4CL can be easily transported, while the integrated suspension system makes its deployment very fast and simple.

Each unit comes with two aluminum brackets and two pins that allows multiple array elements to be easily combined either together, with inter-cabinet angles of 0°, 2° and 4°.



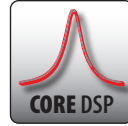

AX1012A / AX1012P

12" Constant Curvature Array Element

AX1012A • Self-powered

AX1012P • Passive

AX1012PWH • Passive white textured paint

AX1012A is a versatile constant curvature full-range element that can be used to create both vertical and horizontal line source arrays and also as a highdirectivity point-source loudspeaker. The 1.4" (2,5" VC) high frequency compression driver is coupled to STW - Seamless Transition Waveguide, which ensures a precise control of mid-high frequencies both on horizontal (100°) and vertical axis (20°), maintained down to 950Hz. for a perfect acoustic coupling between the enclosures that form the array and a sharp SPL off-axis rejection used to avoid reflecting surfaces in the enclosure coupling plane and perfectly adjusts the acoustic coverage to the audience geometry.



STW

Thanks to the Seamless Transition Waveguide the system designer or sound engineer can build true line source horizontal or vertical arrays in 20° building blocks with seamless integration between cabinets

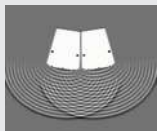

Traditional HF horns

Phase interactions between traditional stand-alone Point Source loudspeakers, featuring poor directionality, make it difficult to achieve consistent and lobefree dispersion. These phenomena produce destructive interferences that affect the tonal balance, clarity and intelligibility at many listening positions.

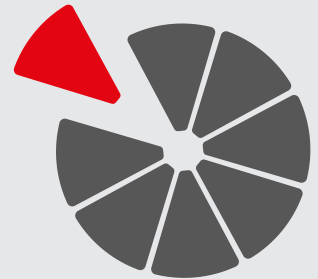

4-unit horizontal array (80°x100°)

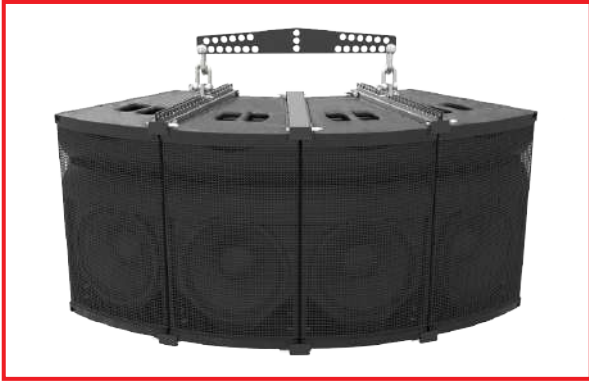

4-unit down firing array (80°x100°)



3-unit vertical array (100°x60°)



3-unit ground stack array (100°x60°)



AX1012 arrays deliver seamless coverage only to desired areas minimizing unwanted reflections of walls and surfaces or avoiding interactions with other sound systems, with the stage or with other areas.

POWER AMPLIFIER

The AX1012A is powered by CLASS D power amplifier with SMPs. Output power : 900 Watts (LF) + 300 Watts (HF) Continuous.

The innovative technology used for these amplifiers offers superior sound definition at any audio frequency, very high dynamics even for low level signals, and very low distortion even at maximum power.

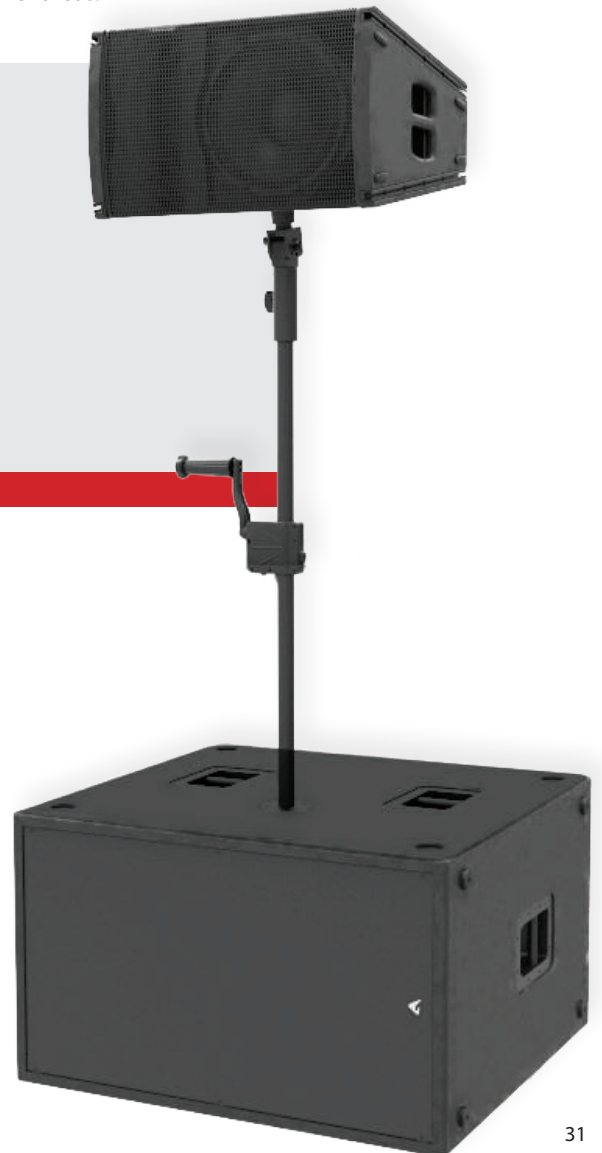



AX2010A / AX2010P

Dual 10" Vertical Array Element

AX2010A • Self-powered

AX2010P • Passive

AX2010PWH • Passive white textured paint

AX2010 Powered or Passive, is a new line array element that combines superior sound quality with easiness and flexibility in a simple system with a very convenient price-to-performance ratio.

The AX2010A has been designed both for rental live sound applications and for fixed installations and has been engineered for the simplest use possible but without sacrificing anything in sound quality and performance.

Dual HF Compression Drivers with Titanium diaphragms 2 x 1.4" throat, 2.5" Voice Coil.

Two transmission line wave-forming waveguides, provide a detailed and natural sound achieving a long distance HF projecting capacity.

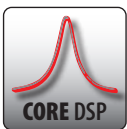
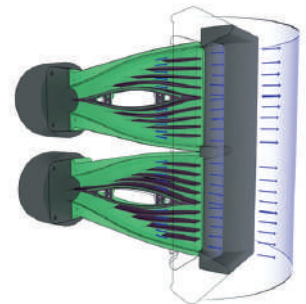

The Transmission Line back loading delivers clean mid-bass reproduction and natural cardioid behavior.

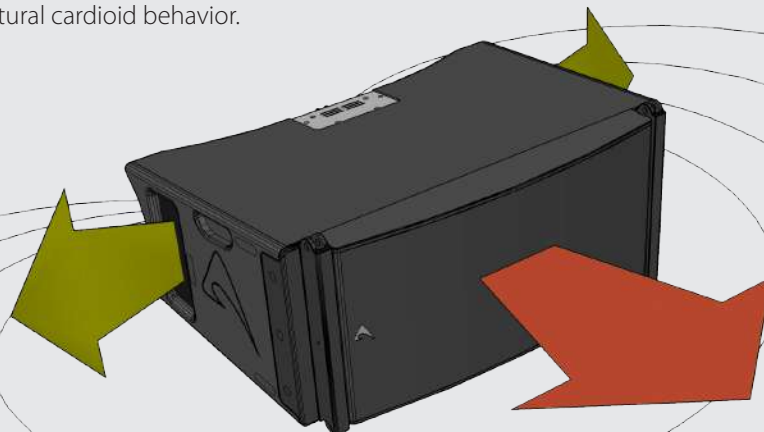



The orientation of the two woofers allows to minimize the interference effect between them, while the use of a mechanical-acoustic polyurethane filter represents a further help in minimizing the midrange beaming.

The two 10" woofers are back loaded by a short hybrid transmission line that minimizes the effect of the box resonances and eliminates the "boxy" mid-bass sound commonly obtained from regular bass-reflex enclosures.

The crossover filter approach is based on a "Constant Power" technique. Thanks to a particular phase combination between the two ways around the crossover frequency, this approach is able to provide a very stable horizontal coverage and a very stable off-axis sound image.

AX2010A can be flown with the **SW36XFA** Flyable 2x18" Subwoofer providing an elegant solution in a unique flown cluster, with usable response down to 36 Hz.

The integrated rigging hardware and the curved grille profile of the AX2010A mates with the SW36XFA, forming a neat and unobtrusive cluster.



POWER AMPLIFIER

The AX1010A is powered by CLASS D power amplifier with SMPS. The innovative technology offers superior sound definition at any audio frequency, very high dynamics even for low level signals, and very low distortion even at maximum power.

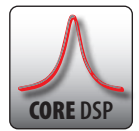

AX2065A / AX2065P

Dual 6,5" Powered and Passive Vertical Array Element

AX2065A • Self-powered

AX2065P • Passive

AX2065PWH • Passive white textured paint

The AX2065P is a compact vertical line array element intended for Rental Companies and fixed installations that require High power-to-size solutions and need to comply a high variety of Venues using the same Line array element.

Its small footprint and narrow width make AX2065 the ideal Main System for small to medium audience spaces, such as corporate events, broadcast studios, fashion shows, theaters, houses of worship, and AV applications. AX2065A also represents the best complement to large systems such as central clusters, side-fills, front-fills, distributed systems.

The Highs are handled by a 1.4" (2.5" VC) Low-distortion compression driver, with lightweight Titanium diaphragm, loaded by a Transmission Line wave-forming waveguide which provides a detailed and natural sound and achieve a longdistance HF projecting capacity.

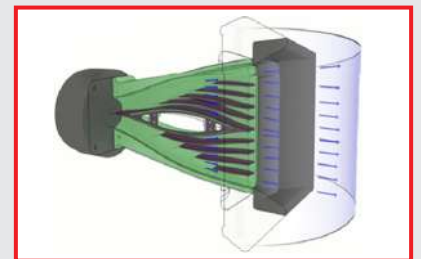

The crossover filter is based on a "Constant Power" technique and a particular phase combination between the two ways around the crossover frequency, this approach is able to provide a very stable horizontal coverage and a very stable off-axis sound image. The orientation of the two woofers minimizes the interference effect between them, while the use of a mechanical-acoustic polyurethane filter represents a further help in minimizing the midrange beaming.

The Transmission Line back loading delivers clean mid-bass reproduction and natural cardioid behavior.

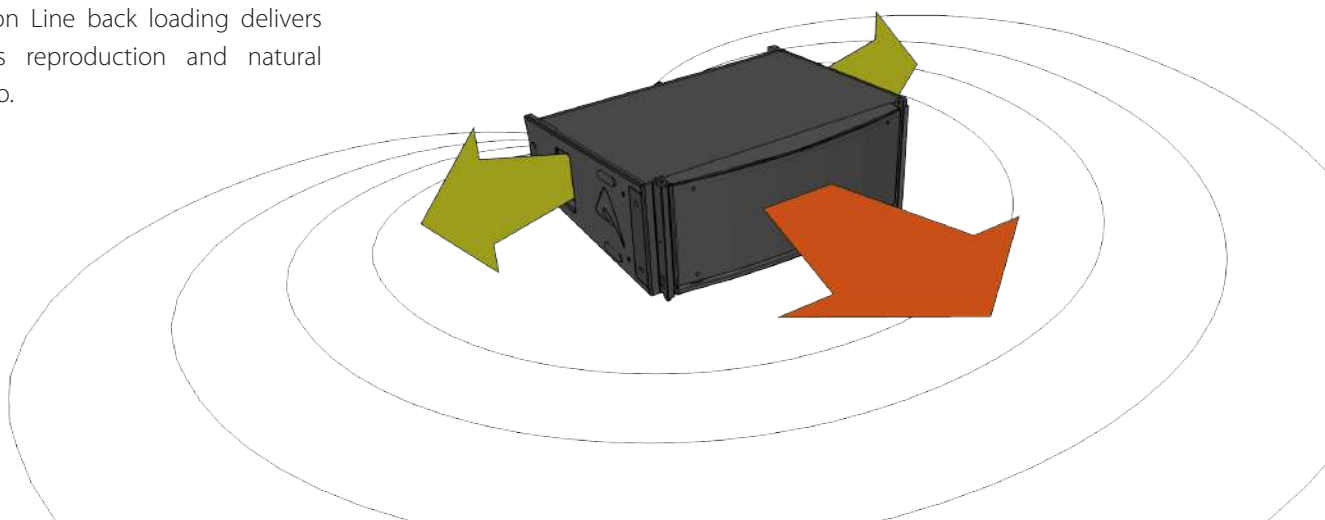



AX2065 offers mid-long throw capability despite its compact format just adding more elements to the array. Such a feature, if compared to an equivalent array composed by big size elements, offers a more articulated and accurate curvature. This flexibility allows AX2065 to serve a big variety of different applications just scaling up or down the system.

AX2065A allows an easy integration with the SW215FA Flyable 2x15" Subwoofer providing an elegant solution in a unique flown cluster.



POWER AMPLIFIER

The AX2065A is powered by CLASS D power amplifier with SMPS. The innovative technology offers superior sound definition at any audio frequency, very high dynamics even for low level signals, and very low distortion even at maximum power.

AX2065A is able to power an additional passive AX2065P module through the available power output on the back panel. This feature will allow to assemble very competitive system solutions both for rental and installation applications.

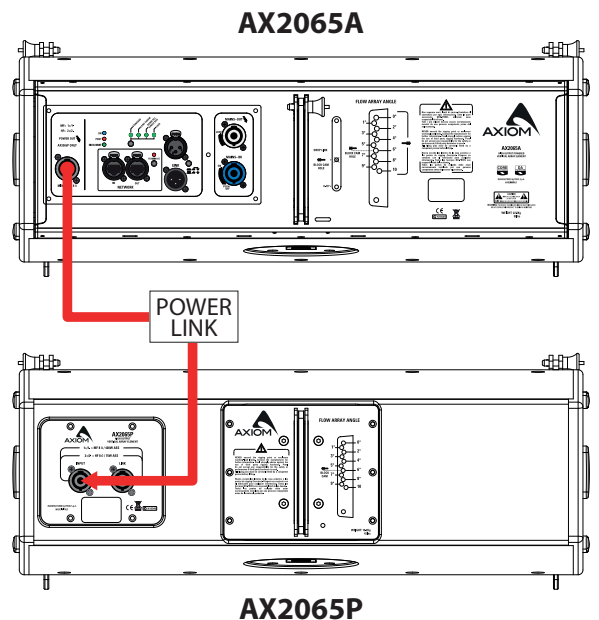
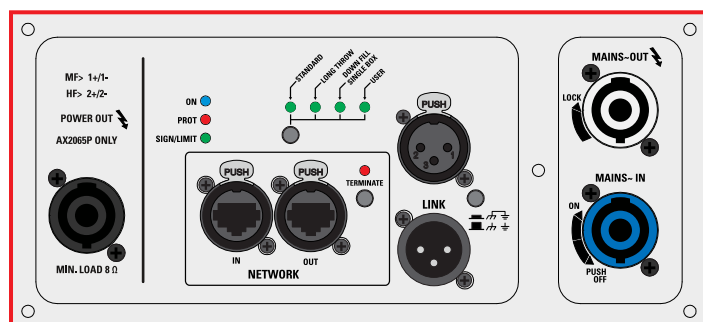

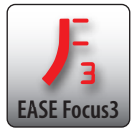
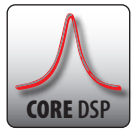

AX800A NEO

New

Dual 8", High Output, Powered, CORE Processed, Two-Way Line Array Element

AX800A NEO is an evolution of the renowned and appreciated **AX800A**, thanks to the introduction of several new technologies combined to the well-known features of its predecessor. It represents a new standard of molded PP enclosure line arrays as it combines superior sound quality, high SPL, innovative look and technologies, ease of use, lightness and **energetic efficiency** but still in a cost-effective way, to bring a higher level of Line arrays to a wide range of users.



HF TRANSDUCER

The high frequency range is reproduced by a low distortion titanium diaphragm compression driver with neodymium magnet and edge-wound 2.5" voice coil, loaded by an acoustic transmission line waveguide.

The exceptionally lightweight high frequency diaphragm features also a very low mechanical resonance that is outside of the pass band which allows a low crossover point of 900Hz.

LF TRANSDUCER

Two 8" neodymium woofers with very lightweight cones ensure fast response at bass and mid-bass frequencies. They are back-loaded by a new Aerodynamic Transmission Line design for clean mid-bass, natural cardioid, minimized enclosure resonances and absence of "boxy" mid-bass sound commonly obtained from regular bass-reflex enclosures.

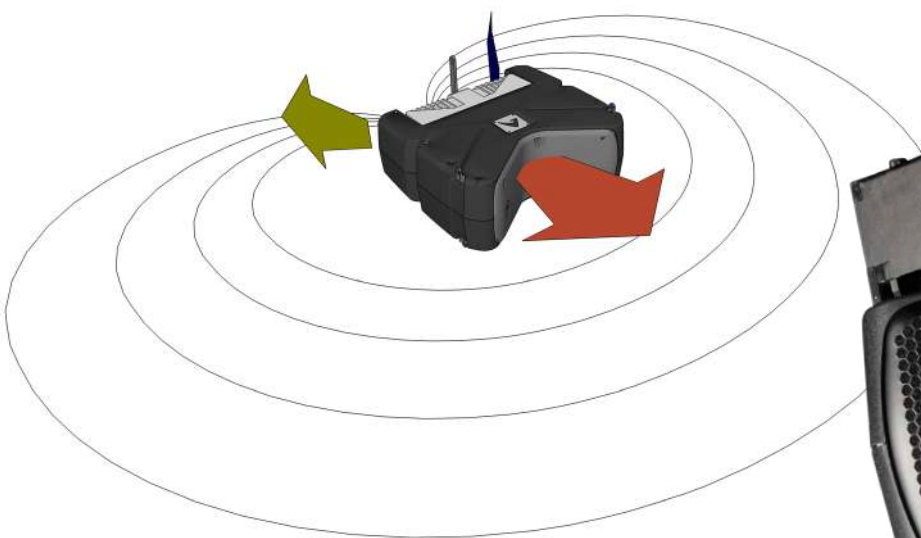

The rigging hardware is fully integrated, making it easy to transport and use, as well as offering the benefits of good protection against harsh environmental conditions.

CONSTRUCTION

The AX800A NEO enclosure is manufactured from structurally rigid polypropylene, internally ribbed to entirely eliminate cabinet resonances, and providing the precise transmission line back loading to the two 8" woofers without the need for additional internal panels.

The positioning of the amplifier module between the outlets of the two rear ducts provides an additional level of cooling.

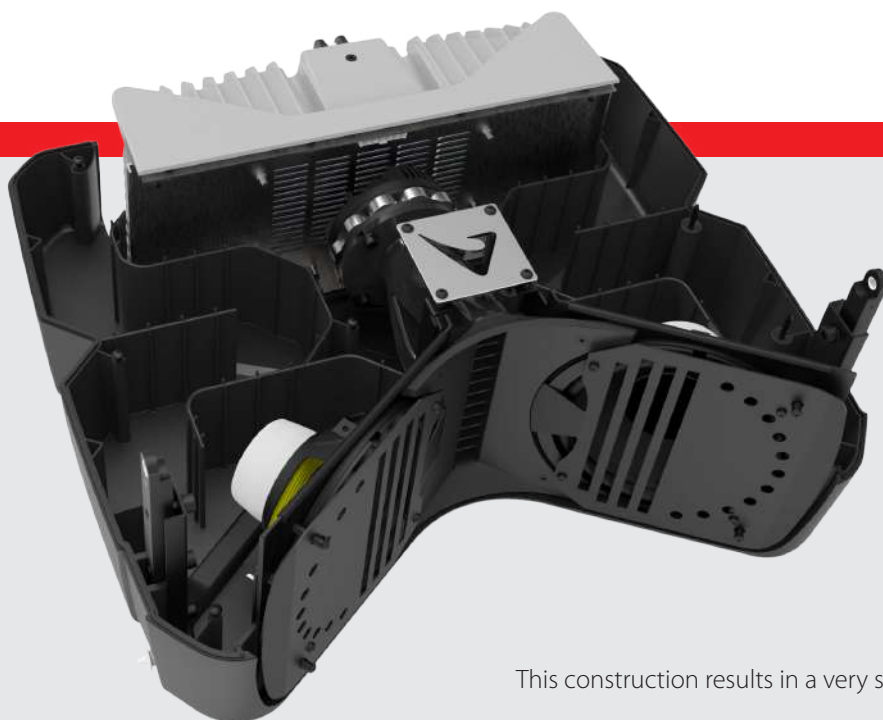

This construction results in a very strong, lightweight, and sonically neutral cabinet.

POWER AMPLIFIER

The AX800A NEO is powered by an extremely compact and lightweight CLASS D power amplifier with SMPS and PFC. The innovative technology used for these amplifiers offers top-of-the range performances.

PFC power supply with automatic mains voltage selection for worldwide operation, guarantees reliability, consistency with a very high efficiency and low power consumption.



Mains power is connected through a locking Neutrik PowerCON system, which includes a Power Out connector allowing mains power to be linked to additional cabinets.

SIGNAL PROCESSING

The system processing is based on the new CORE2 DSP platform designed by the PROEL R&D Laboratories using one of the most advanced SHARC DSP devices available for audio applications.

It features 40bit, floating point resolution and top-quality 24-bit AD/DA converters for perfect signal integrity, dynamic range in excess of 110dB, and superior sonic performance.

Thanks to its massive processing power, the CORE platform is capable of providing the most sophisticated algorithms for speaker processing, including linear phase FIR filters, together with comprehensive remote control and networking capabilities.



The PRONET AX control software, working on a solid and reliable CANBUS based network protocol, provides an intuitive interface for the remote control of the whole audio system via the rear panel etherCON RJ45 connectors, with the possibility to equalise and delay individual devices, as well as setting driver protection parameters, and monitoring the status of the amplifier.

Four factory DSP presets are provided for when the AX800A NEO cabinets are not connected to a network, and allow for rapid and simple setup:

- Standard
- Long Throw
- Down-fill / Single Box
- User - for specific situations when off-line

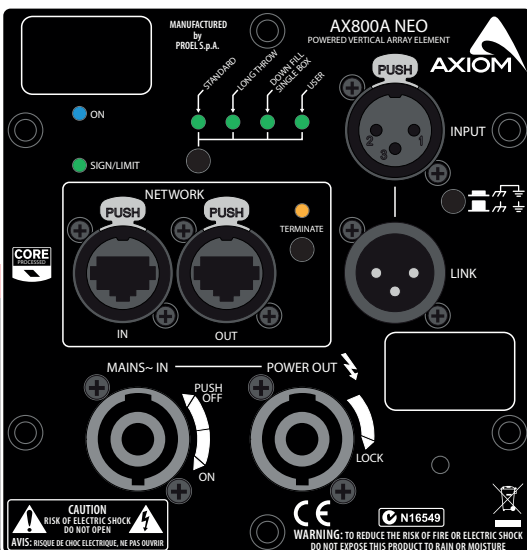

APPLICATIONS

To fully extend low frequency response, the **AX800A NEO** can be combined to many different AXIOM Subwoofers thanks to the new factory presets featuring harmonized subwoofer phase responses and excellent mutual-coupling.

This allows totally free combinations among AXIOM's Line Array and Subwoofer models.

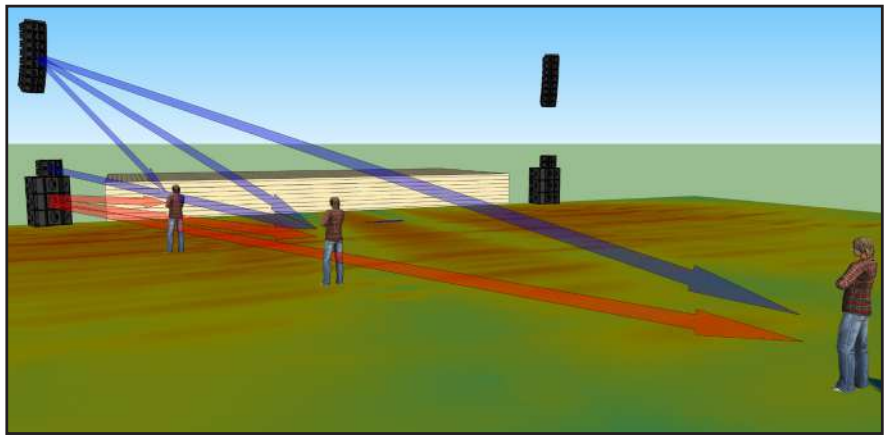

SW1800A

Compact dual 18", manifolded bandpass design 1000W + 1000W continuous power.

SW1800A can be used with AX800A NEO in a recommended 4:1 ratio for basic/multipurpose setups or 3:1 for more demanding gigs.



SW2100A

High Output, Ultra-Compact 21", 4000W Subwoofer

- 2000W used to drive its internal 21" Woofer
- 2000W used to drive an external SW2100P 21" Subwoofer

To make SW2100A able to drive SW2100P, specific Presets must be requested to the AXIOM technical support

AX800A NEO combined to SW2100A + SW2100P is an innovative, highly scalable and very powerful solution.

Subs and line array elements are all provided by PFC power supply.



SW2100P
Passive



SW2100A
Self-Powered

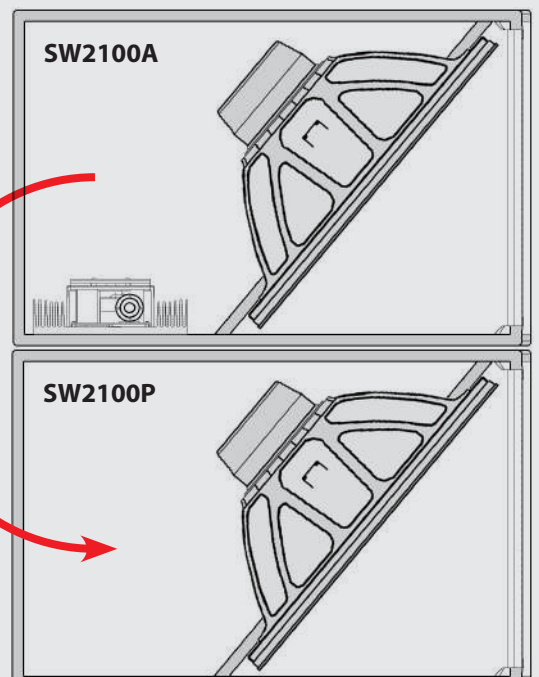

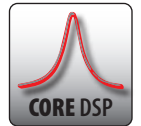

AX800A

Dual 8" Powered Vertical Array Element

The AX800A defines the standard by which small format compact line array performance can be measured, in portable and fixed sound reinforcement applications where ease of setup and use together with quality sound are critical.

The AX800A is a compact powered line array consisting of two eight-inch low frequency drivers, Transmission Line back-loaded for natural cardioid behavior and clean mid-bass reproduction, and a 1.4-inch titanium diaphragm compression driver loaded by an acoustic Transmission Line waveguide providing natural sounding high frequencies. These high grade Italian sourced components are arranged in a very compact WTW driver configuration, which lends itself to correct line array behavior, providing wide and even horizontal coverage of any venue or audience space.

The AX800A enclosure is moulded from structurally rigid polypropylene, internally ribbed to eliminate cabinet resonances, and provides the Transmission Line back loading path for the two 8" woofers, also allowing the rigging hardware to be fully integrated.

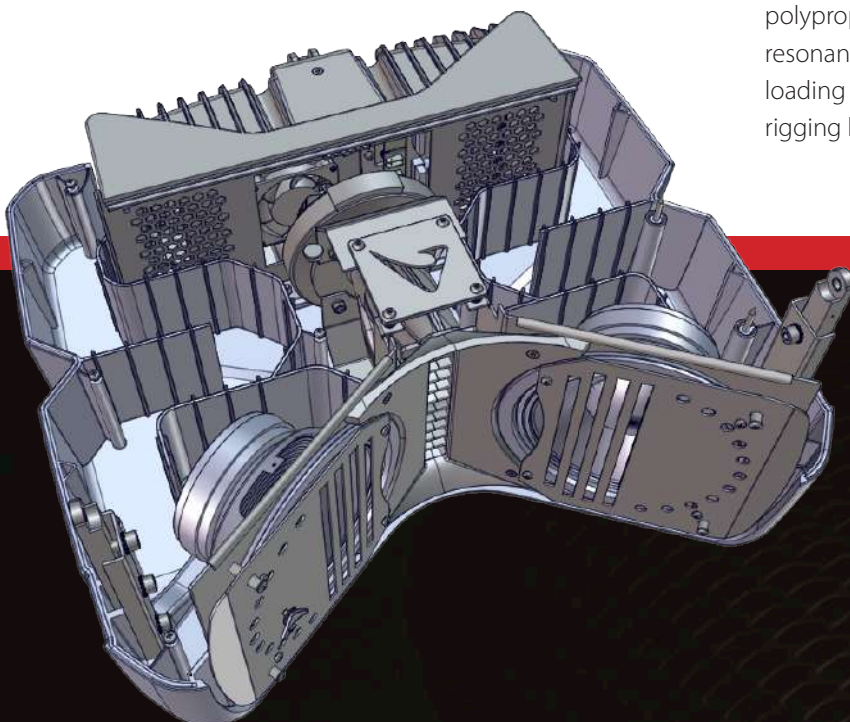

The Transmission Line back loading delivers clean mid-bass reproduction and natural cardioid behavior.

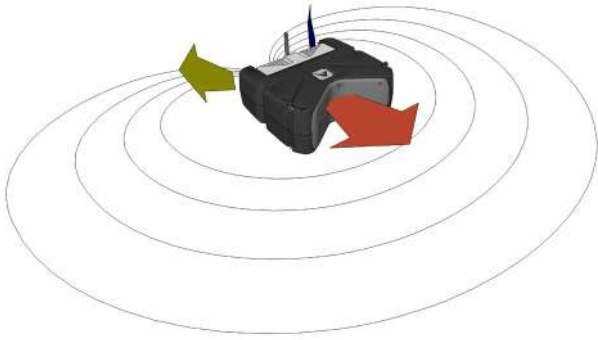

The AX800A and SW1800A powered subwoofer together make a formidable plug-and-play solution for a myriad of portable sound reinforcement situations, with the dual 18" SW1800A providing the lower octave of full frequency response, and enough SPL and coverage for small to medium indoor or outdoor events. Two AX800A cabinets can be pole mounted, with adjustable height and angle, over one subwoofer to give a powerful system for corporate audio-visual and small band applications that is quick and easy to set up and obtain consistently repeatable performance.



POWER AMPLIFIER

The AX1010A is powered by CLASS D power amplifier with SMPS. The innovative technology offers superior sound definition at any audio frequency, very high dynamics even for low level signals, and very low distortion even at maximum power.

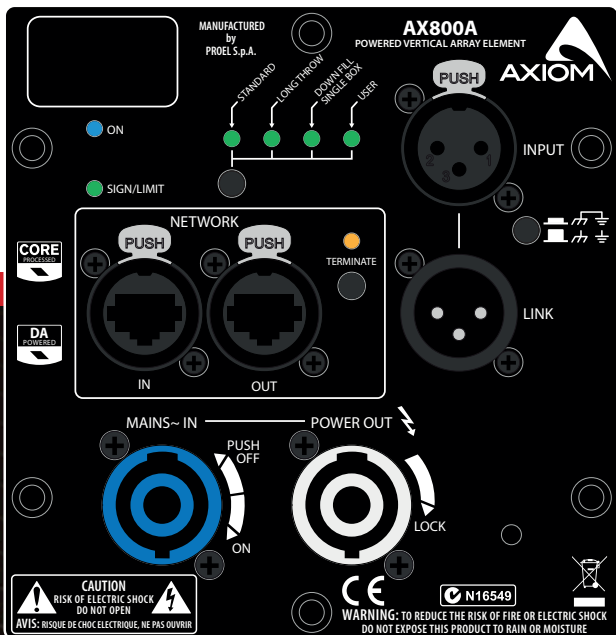

AX LINE ARRAYS

TECHNICAL SPECIFICATIONS

	AX12C	AX6C	AX12LF
Configuration	12 x 3.5" Full Range	6 x 3.5" Full Range	12 x 3.5" Full Range
Frequency Response	180 Hz - 16kHz ±3dB (processed)	200 Hz - 16kHz ±3dB (processed)	90 Hz - 200Hz ±3dB (processed)
Nominal Impedance	16 Ω	32 Ω	8 Ω
Max Peak SPL	130 dB SPL @ 1m	124 dB SPL @ 1m	124 dB SPL @ 1m
Power Handling	360 W (AES) 720 W (Prgm)	180 W (AES) 360 W (Prgm)	320 W (AES) 640 W (Prgm)
Amplifier Power Output	N/A	N/A	N/A
Coverage Angle @ -6dB points	100° H x 2° V	100° H x 2° V	360° H x 2° V
Dimensions (WxHxD) mm / ins	107 x 1166 x 193 4.2" x 45.9" x 7.6"	107 x 626 x 193 4.2" x 24.6" x 7.6"	107 x 1166 x 193 4.2" x 45.9" x 7.6"
Net Weight	13 kg / 28.6 lbs	8.9 kg / 19.62 lbs	13.2 kg / 29 lbs
Enclosure	Alluminium Extruded	Alluminium Extruded	Alluminium Extruded
Finish	Black paint White paint	Black paint White paint	Black paint White paint
Rigging	Integrated system optional brackets	Integrated system optional brackets	Integrated system optional brackets
Mains Connectors	N/A	N/A	N/A

The ess
of

	AX16CL <small>New</small>	AX8CL <small>New</small>	AX4CL <small>New</small>
Configuration	16 x 2.5" Full Range	8 x 2.5" Full Range	4 x 2.5" Full Range
Frequency Response	200 Hz - 16kHz ±3dB (processed)	200 Hz - 16kHz ±3dB (processed)	200 Hz - 16kHz ±3dB (processed)
Nominal Impedance	32 Ω	64 Ω	32 Ω
Max Peak SPL	128 dB SPL @ 1m *	122 dB SPL @ 1m *	116 dB SPL @ 1m *
Power Handling	320 W (AES) 640 W (Prgm)	160 W (AES) 320 W (Prgm)	80 W (AES) 160 W (Prgm)
Amplifier Power Output	N/A	N/A	N/A
Coverage Angle @ -6dB points	80° H x 2° V	80° H x 2° V	80° H x 2° V
Dimensions (WxHxD) mm / ins	90 x 1190 x 154 3.5" x 46.9" x 6.1"	90 x 654 x 154 3.5" x 25.8" x 6.1"	90 x 390 x 154 3.5" x 15.3" x 6.1"
Net Weight	11,5 kg / 25.4 lbs	6 kg / 12.2 lbs	4 kg / 8.8 lbs
Enclosure	Alluminium Extruded	Alluminium Extruded	Alluminium Extruded
Finish	Black paint White paint	Black paint White paint	Black paint White paint
Rigging	Integrated system optional brackets	Integrated system optional brackets	Integrated system optional brackets
Mains Connectors	N/A	N/A	N/A

ence
Sound

AX LINE ARRAYS

TECHNICAL SPECIFICATIONS

	AX1012A	AX1012P	AX2010A	AX2010P
Configuration	1 x 12" (3"VC) LF 1 x 1.4" (2.4"VC) HF	1 x 12" (3"VC) LF 1 x 1.4" (2.4"VC) HF	2 x 10" (2.5VC) LF 2 x 1.4" (2.5"VC) HF	2 x 10" (2.5VC) LF 2 x 1.4" (2.5"VC) HF
Frequency Response	65 Hz - 17kHz -6dB (processed)	65 Hz - 17kHz -6dB (processed)	75 Hz - 18kHz ±3dB (processed)	75 Hz - 18kHz ±3dB (processed)
Nominal Impedance	N/A	8 Ω + 8 Ω	N/A	8 Ω + 8 Ω
Max Peak SPL	134 dB SPL @ 1m	134 dB SPL @ 1m	138 dB SPL @ 1m	138 dB SPL @ 1m
Power Handling	N/A	600W+75W (AES) 1200W+150W (Prgm)	N/A	700W+150W (AES) 1400W+300W (Prgm)
Amplifier Power Output	900W + 300W Class D (continuous Pwr.)	N/A	1000W + 1000W ClassD (continuous Pwr.)	N/A
Coverage Angle @ -6dB points	100° H x 20° V	100° H x 20° V	110° H x 10° V	110° H x 10° V
Dimensions (WxHxD) mm / ins	246 x 611 x 500 9.7" x 24.0" x 19.7"	246 x 611 x 500 9.7" x 24.0" x 19.7"	746 x 341 x 530 29.4" x 13.4" x 20.9"	746 x 341 x 530 29.4" x 13.4" x 20.9"
Net Weight	32.5 kg / 71.6 lbs	30.5 kg. / 67.3 lbs	40.3 kg / 88.7 lbs	39.9 kg / 87.9 lbs
Enclosure	15mm phenolic birch plywood	15mm phenolic birch plywood	15mm phenolic birch plywood	15mm phenolic birch plywood
Finish	Black textured paint	Black or White textured paint	Black textured paint White textured paint	Black or White textured paint
Rigging	Captive suspension system	Captive suspension system	Integrated system	Integrated system
Mains Connectors	PowerCON™	N/A	PowerCON™	N/A

The ess
of

	AX2065A	AX2065P	AX800A NEO 	AX800A
Configuration	2 x 6.5" (1.5VC) LF 2 x 1.4" (2.5"VC) HF	2 x 6.5" (1.5VC) LF 2 x 1.4" (2.5"VC) HF	2 x 8" (2"VC) LF 1 x 1.4" (2.5"VC) HF	2 x 8" (2"VC) LF 1 x 1.4" (2.5"VC) HF
Frequency Response	80 Hz - 18kHz ±3dB (processed)	80 Hz - 18kHz ±3dB (processed)	85 Hz - 16.8kHz ±3dB (processed)	85 Hz - 16.8kHz ±3dB (processed)
Nominal Impedance	N/A	8 Ω + 8 Ω	N/A	N/A
Max Peak SPL	129 dB SPL @ 1m	129 dB SPL @ 1m	133.5 dB SPL @ 1m	132 dB SPL @ 1m
Power Handling	N/A	400W + 75W (AES) 800W + 150W (prgm)	N/A	N/A
Amplifier Power Output	1000W + 1000W ClassD (continuous Pwr.)	N/A	800W + 400W ClassD (continuous Pwr.)	900W + 300W ClassD (continuous Pwr.)
Coverage Angle @ -6dB points	110° H x 12° V	110° H x 12° V	100° H x 10° V	100° H x 10° V
Dimensions (WxHxD) mm / ins	583 x 244 x 481 22.9" x 9.6" x 18.9"	583 x 244 x 481 22.9" x 9.6" x 18.9"	600 x 265,5 x 516 23.6" x 10.5" x 20.3"	600 x 265 x 516 23.6" x 10.5" x 20.3"
Net Weight	22.5 kg / 49.6 lbs	19.2 kg / 42.3 lbs	22.5 kg / 49.6 lbs	25 kg / 55.1 lbs
Enclosure	15mm phenolic birch plywood	15mm phenolic birch plywood	Polypropylene	Polypropylene
Finish	Black or White textured paint	Black or White textured paint	Black textured	Black textured
Rigging	Integrated system	Integrated system	Integrated system	Integrated system
Mains Connectors	PowerCON™	N/A	PowerCON™	PowerCON™





CX STAGE MONITORS



KEY FEATURES

- High output Coaxial Stage Monitors
- Very compact size and low-profile design
- Single magnet neodymium motor
- Controlled dispersion for excellent close listening performance and consistent off-axis coverage
- 96KHz / 40bit floating point CORE processing with PRONET AX remote control
- Dynamic EQ, for a full dynamic range at any level
- Digitally controlled Class D amplifier module with SMPS

CX Series Stage Monitors are amongst the most compact and powerful in their class, designed around a minimal spacesaving footprint that makes them unobtrusive on stage. This is achieved by the use of innovative coaxial drive units that help to eliminate the time and phase problems that can occur with discrete non-coincident sources. Constructed with two different angles sides, the CX Series monitors also feature integral pole holders to enable use as front of house loudspeakers. The integrated Class D amplifiers and built-in DSP offers factory presets for consistent performance on any concert stage, and delivers top of the range performance, superior sound definition at any audio frequency, and very high dynamic range even at maximum power.

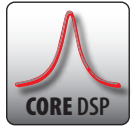

CXL12A

12" Coaxial Powered Stage Monitor

CXL12A is the lightest and most compact stage monitor of CX series, weighing in at only 15 kg and standing just 32 cm high and 45 cm wide. These characteristics make it ideal for applications that require a discreet footprint, controlled directivity and the highest possible performance/weight ratio. This monitor combines a high-performance coaxial transducer with a carefully designed cabinet and powerful electronics, which enable it to deliver very high SPL before feedback and excellent intelligibility, even at very high levels.

The coaxial design of the transducer provides a very stable acoustic pattern on both the horizontal and vertical axes. The motor of this component uses a single neodymium magnet configuration to reduce the delay between the two sources, eliminating time and phase problems. For the high frequencies, CXL12A uses a low-distortion compression driver with a 1.7" aluminum voice coil and a polyimide diaphragm. This driver is coupled with a **proprietary horn** that provides a precise and controlled radiation with a divergence of 50° in the horizontal plane and 70° in the vertical. The 12" woofer incorporates a 2.5" voice coil and features a water-repellent cone, which enables CXL12A to be used in adverse weather conditions.



The shape of the cabinet permits a choice between two deployment angles, 60° and 40° relative to the floor, therefore allowing the user to adjust for different throw distances from the musicians according to the size of the stage and to the type of monitoring needed. A convenient dual-angle flange also allows the CXL12A to be mounted on a standard speaker stand, for use as a multipurpose front-of-house enclosure.

The powerful class D amplifier and CORE DSP processing enable the CXL12A to develop very high sound pressure levels before feedback and provide excellent intelligibility, even at very high output levels. The CORE LT DSP signal processing includes a sophisticated Dynamic EQ, which can accurately shape the system's sound, while maintaining a full dynamic range at any level. Five EQ presets are available to adapt the monitor to different applications, including use as a FoH system.

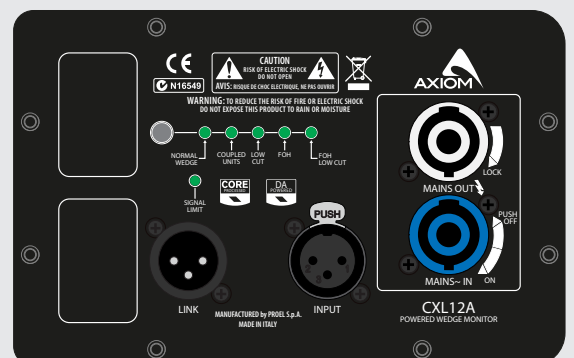

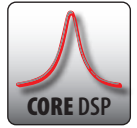

CX14A

14" Coaxial Powered Stage Monitor

The CX14A is one of the most compact and lightweight stage monitors in its category, designed specifically for live sound, although the very compact, low-profile enclosure also makes it suitable for theatre and television applications.

The unique 14" LF transducer's coaxial design offers a very stable acoustical pattern over 80° in both the horizontal and vertical axes. The high frequency range is reproduced by a low-distortion compression driver equipped with a 3" aluminum voice coil and polyester/titanium diaphragm.

The combination of a high-performance coaxial transducer, a carefully designed cabinet, and powerful Class D amplifier together with CORE DSP processing provides very high SPL before feedback and excellent intelligibility even at very high power.



The 45° and 55° angled sides enable it to be positioned at differing distances from the performers depending on the stage size and type of monitoring needed. A convenient dual-angle pole holder allows the CX14A to be mounted on a standard speaker stand to be used as a multipurpose front of house loudspeaker.

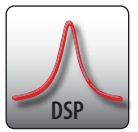

CX15A

High End 15" Coaxial Powered Stage Monitor

The CX15A is an extremely compact and lightweight low-profile birch cabinet suitable for applications where the unobtrusive size is a must, providing exceptional intelligibility and high gain before feedback. It is ideally suited to live sound stage monitoring, as well as to theatre and television applications.

The co-axial driver configuration provides a very small footprint on stage while giving the output of a much larger unit. The dispersion pattern is optimised for general purpose monitoring applications at 80° conical, so allowing performers freedom to move around on stage but still stay within the coverage pattern.



96KHz / 40bit floating point CORE DSP and digitally controlled 2000W Class D amplifier with SMPS providing a superior sonic performance and a very high SPL before feedback.

Weather-proof coaxial transducer with single magnet neodymium motor for a very stable acoustical pattern and great sound intelligibility.

Specially designed reflex ports are on the front of the cabinet and aimed towards the floor where some beneficial mutual coupling occurs in the 80 Hz region, tightening up the bass response and increasing definition.

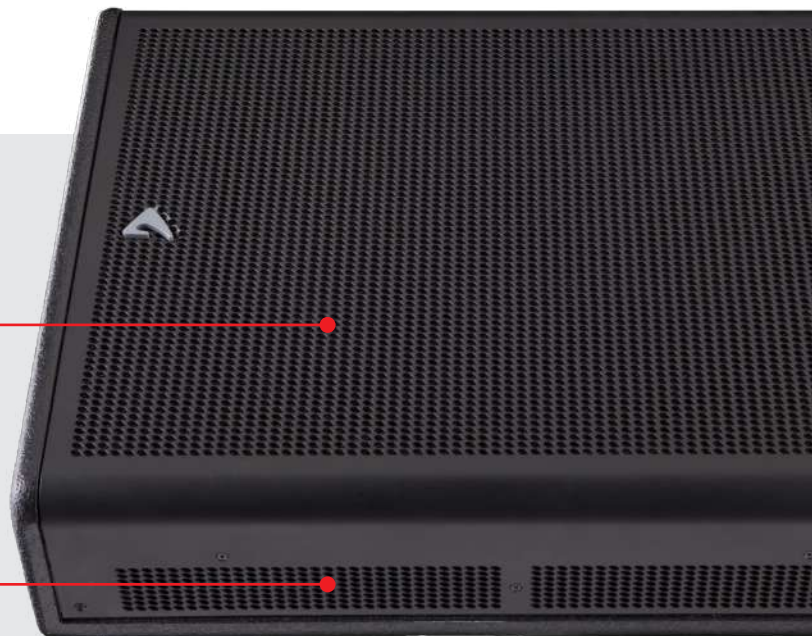

CX STAGE MONITORS

TECHNICAL SPECIFICATIONS

	CXL12A	CX14A	CX15A
Configuration	1 x 12" (2.5"VC) LF 1 x 1" (1.7"VC) HF	1 x 14" (3"VC) LF 1 x 2" (3"VC) HF	1 x 15" (3"VC) LF 1 x 1.4" (2.4"VC) HF
Frequency Response	75 Hz - 18kHz ±3dB (processed)	70 Hz - 18kHz ±3dB (processed)	60 Hz - 18kHz ±3dB (processed)
Max Peak SPL	129 dB SPL @ 1m	131 dB SPL @ 1m	131 dB SPL @ 1m
Amplifier Power Output	900W + 300W ClassD (continuous Pwr.)	900W + 300W ClassD (continuous Pwr.)	1000W + 1000W ClassD (continuous Pwr.)
Coverage Angle @ -6dB points	50° H x 70° V	80° H x 80° V	80° H x 80° V
Dimensions (WxHxD) mm / ins	451 x 322 x 405 17,76" x 12,67" x 15,94"	507 x 316 x 403 20" x 12,4" x 15,8"	520 x 336 x 415 20,5" x 13,2" x 16,3"
Net Weight	15 kg / 33 lbs	16 kg / 35.3 lbs	18.5 kg / 40.8 lbs
Enclosure	15mm phenolic birch plywood	15mm phenolic birch plywood	15mm phenolic birch plywood
Finish	Black textured paint	Black textured paint	Black textured paint
Mains Connectors	PowerCON™	PowerCON™	PowerCON™





SW SUBWOOFERS

KEY FEATURES

- Very high energy at sub-bass and bass frequencies
- Manifolded Transmission Line and Manifolded Bandpass configurations
- Long excursion split coil for extended linear response
- Tetracoil Dual Voice Coils
- Water repellent, reinforced speaker cones
- Digitally controlled Class D amplifier module with SMPS
- 96KHz / 40 bit floating point CORE processing
- PRONET AX remote control software

SW Series subwoofers are designed to provide highly energetic sub-bass support for AX Series line arrays and ED Series point source loudspeakers. They are designed to be physically and acoustically compatible with all AXIOM systems in a wide variety of indoor and outdoor concert touring, festival, and fixed installation applications. Powered versions offer unparalleled levels of performance and convenience of operation with minimal weight penalty.



SW2100A / SW2100P

High Output 21" Subwoofer

SW2100A • Self-powered

SW2100P • Passive

SW2100PWH • Passive white textured paint

The SW2100A is a high output Band-Pass/Bass-Reflex subwoofer designed to provide a deep and defined low-frequency extension not only to AX12C and AX6C column arrays, but also to several other AX and ED loudspeaker systems.

It features a Class D amplifier module with PFC, Power Factor Correction, which delivers in an ultra-compact package 2000W from each of its two channels: one channel is used to drive the 21" woofer, the other, through an output SPEAKON connector, can power AX12C or AX6C line array modules.

The 96kHz / 40 bit CORE digital signal processing provides optimised presets for use in conjunction with various combinations of AX12C and AX6C elements.



The drive unit is a 4" voice coil 21" neodymium transducer equipped with triple-roll suspension to maintain linear coil travel over the very high excursion, needed to deliver exceptional SPL at frequencies as low as 34Hz.

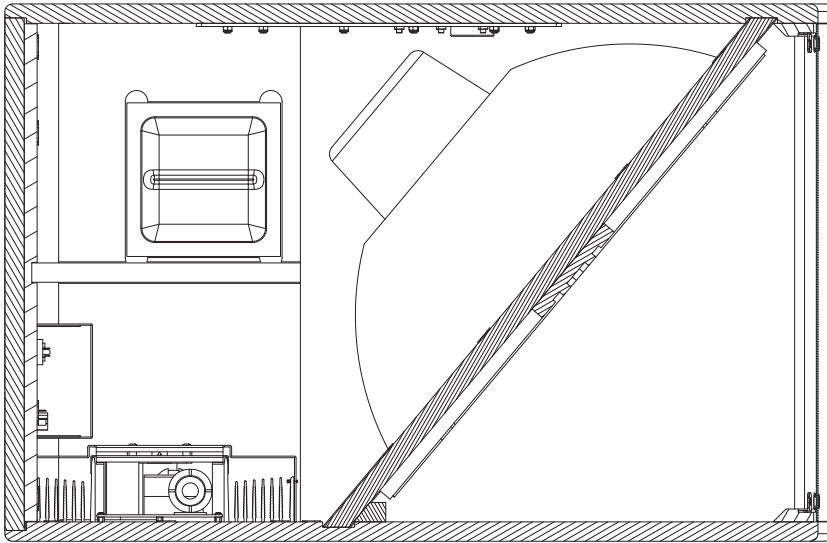

An integrated metal plate provides a mounting point for AX Series column speakers and heavy duty wheels enable transportation.

The powered version SW2100A is specifically designed to be used with AX12C and AX6C column arrays.





SW212A

New

Dual 15" High Output, Powered Bandpass Subwoofer

The SW212A is a very compact Band-Pass/Bass-Reflex subwoofer providing high output and extended low frequency response.

It is equipped with a two 12" neodymium transducers with a 3.5" aluminium voice coil, large displacement suspension system, and water repellent cone, able to provide clean and undistorted LF reproduction at very high SPL.

The SW212A is powered by a new generation of CLASS D power amplifier with digitally-controlled SMPS, which offers top performance, superior sound definition at any audio frequency, very high dynamics for low level signals, very low distortion even at maximum power, higher dynamic range, very compact size, light weight, and efficiency above 90%.





The assembly of a System is a great example of the AXIOM design.

Visually discreteness, elegance and high performance-to-size ratio, best match different architectural needs of a multitude of environments.

AX8CL

AX16CL

AX16CL

AX16CL

The SW212A has been mainly designed to provide the optimal low frequency extension to the AX16/8CL line array modules.

SET IT UP IN NO TIME AT ALL

The SW212A features on the top panel a special metal plate and it comes with a dedicated bracket for fast coupling with the AX16/8CL's rigging hardware.

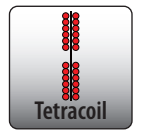
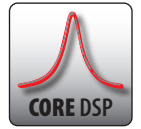

SW218XA / SW218XP

High Output Dual 18" Manifolded Subwoofer

SW218XA • Self-powered

SW218XP • Passive

The SW218XP is the ideal solution for rental and installation companies looking to increase total system SPL capability for the same amount of physical inventory. It is well suited to concert touring and festival applications requiring higher levels of low frequency response such as hard rock and electronic music.

The reinforced birch plywood enclosure is fitted with stacking feet to enable stable ground stacks, and heavy duty wheels for easy transportation.

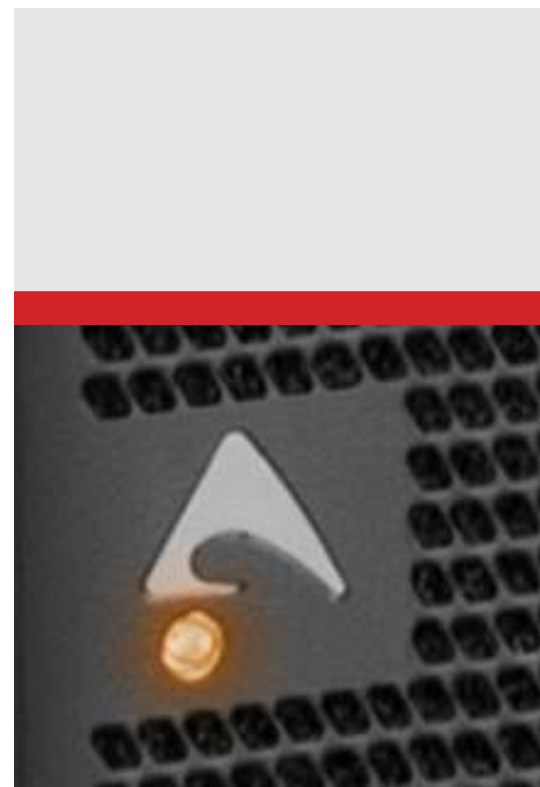
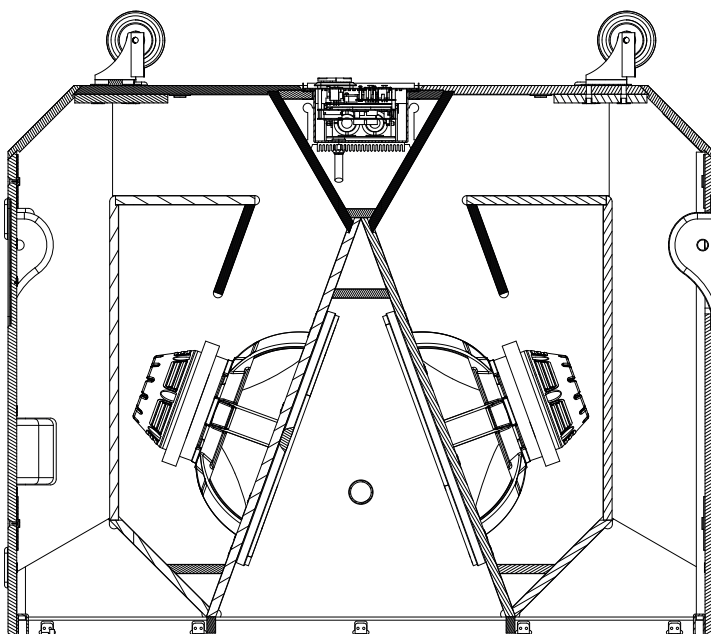

TETRACOIL TECHNOLOGY

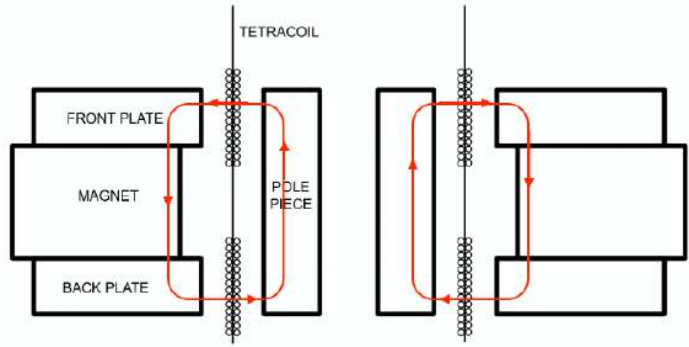

Two separate voice coils wound on both side of the same former and suspended in two axially separated magnetic gaps, enabling extreme excursion of the cone and excellent thermal dissipation.



The Manifolced Transmission Line combines two acoustic principles: manifold loading the output of two cone drivers for beneficial mutual coupling and improved efficiency, while simultaneously Transmission Line loading the rear of the cones, thereby speeding up transient response and further increasing efficiency.

SW218XFA features a Class D amplifier module with PFC, (Power Factor Correction), which delivers in an ultracompact package 4000W from its two channels.

SW36XFA / SW36XFP

Dual 18" Manifolded Bandpass Subwoofer

SW36XFA • Self-powered

SW36XFP • Passive

SW36XFPWH • Passive white textured paint

Designed to be flown with AX2010 A/P line array modules, the SW36XF A/P provides an elegant solution to delivering 'bass in the sky' from a flown cluster, with usable response down to 36 Hz. When positioned at the top of the array its integrated rigging hardware mates with the AX2010 A/P and the curved grille profile also matches the AX2010, forming a neat and unobtrusive cluster.

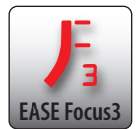
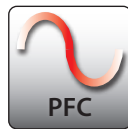
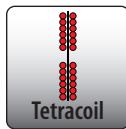
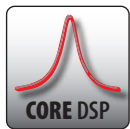

Offering impressive efficiency from a compact cabinet, the SW36XFP uses a combination of manifold and bandpass loading techniques to achieve an impressive 143 dB peak output.

Its dual 18" low frequency drivers feature 4" Tetracoil dual voice coils, which have the equivalent performance to a single 6" voice coil.

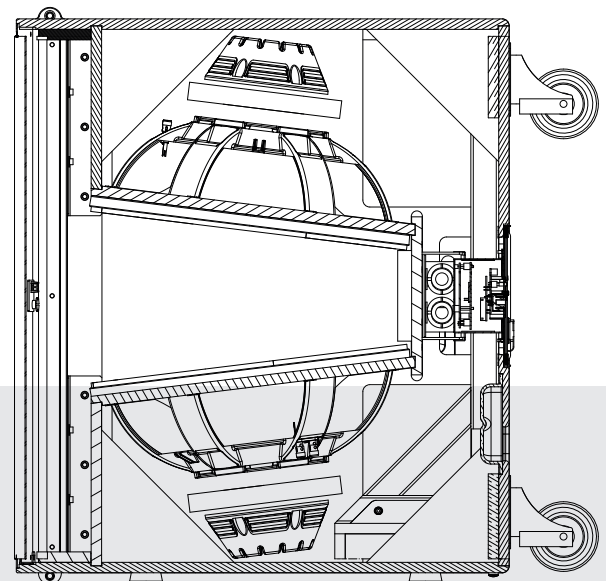

TETRACOIL TECHNOLOGY

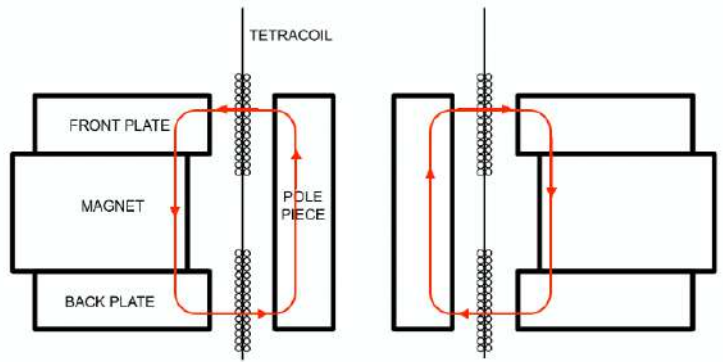

Two separate voice coils wound on both side of the same former and suspended in two axially separated magnetic gaps, enabling extreme excursion of the cone and excellent thermal dissipation.

SW36XFA features a Class D amplifier module with PFC, (Power Factor Correction), which delivers in an ultra-compact package 2 x 2000W.

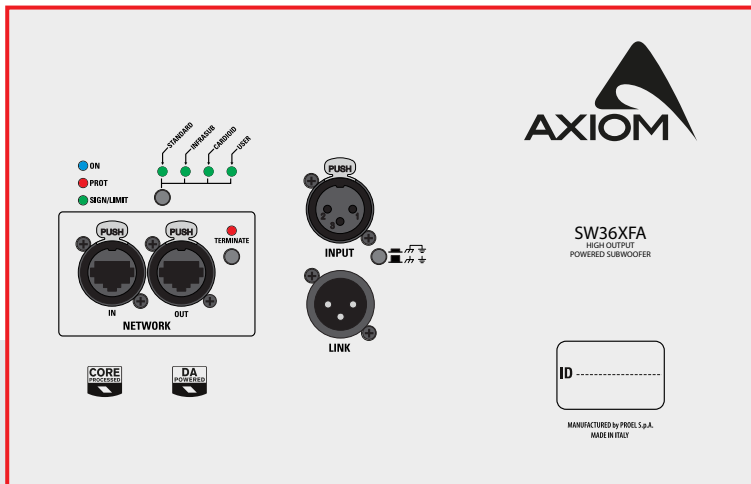

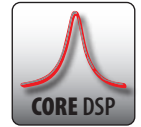

SW1800A

Dual 18" Powered Manifolded Subwoofer

The SW1800A is a lightweight compact subwoofer designed for rental companies and fixed installations requiring high power-to-size ratio. It can be used in a wide range of multiple subwoofer setups, such as arc delays, end-fire or cardioid configurations, and it can deliver high efficiency and punchy lows from a compact enclosure.

The two custom 3" voice coil 18" drivers are loaded by a Manifolded Bandpass design that maximises mutual coupling between the drive units to gain advantages in definition both at the lowest frequencies and in the upper bass region.



The integrated Class D amplifier with SMPS delivers 1000 watts into each driver individually, offering superior sound quality with very low distortion even down to sub-bass frequencies. The birch plywood cabinet is equipped with heavy duty wheels, stacking feet, flush handles, and two pole mount sockets to allow flexible mounting arrangements.

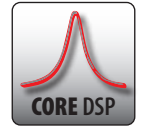
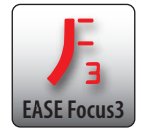

SW215P / SW215FP

SW215A / SW215FA

Dual 15" Manifolded Subwoofer

SW215A • Self-powered

SW215FA • Flyable, Self-Powered

SW215P • Passive

SW215FP • Flyable, Passive

The SW215 system is a compact double 15" subwoofer, physically and sonically compatible with AX2065A/P compact line arrays, designed for high quality sound reinforcement in touring applications and fixed installations such as musicals, fashion shows, corporate events, live music venues, theatres, and concert halls. It represents also the best complement to large systems such as side-fills and drum fills to provide solid and cohesive bass response.

The SW215 system features a unique, innovative Manifolded Bandpass cabinet configuration to deliver articulate and punchy upper bass frequencies with an emphasis on the 60 Hz to 90 Hz region where much of the impact of today's music is felt.

The SW215FP and SW215FA are flown version with integral flying hardware able to be easily integrated with the AX2065A/P, providing an elegant solution in a unique flown cluster.



The SW215A includes a 2000 watt Class D amplifier module with advanced CORE DSP processing that can be very easily controlled and monitored with PROEL's intuitive PRONET AX software running on a Windows PC, providing a high degree of driver protection and security.

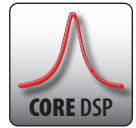

SW18A / SW18P

18" Direct Radiating Subwoofer

SW18A • Self-powered

SW18P • Passive

SW18PWH • Passive white textured paint

The SW18P is a high power compact subwoofer designed to partner ED Series point source loudspeakers for fixed installations in discotheques, nightclubs and bars, and live music clubs, and for portable corporate audio-visual applications. It features a high excursion 4" voice coil, 18" driver equipped with a double centred spider that maintains linear voice coil travel even at high output levels. The phenolic birch plywood cabinet is equipped with a pole mount socket, stacking feet, flush handles, and heavy duty wheels to enable easy handling and transportation. It will deliver punchy bass performance from a very compact cabinet, and thanks to.

The powered SW18A features an integrated 2000 watt class D amplifier module that provides convenience and simplicity of connection for portable sound reinforcement applications.





SW210P

Dual 10" Direct Radiating Subwoofer

SW210P • Passive

SW210PWH • Passive white textured paint

The SW210P is a very compact direct radiating subwoofer that due to its low profile is ideal for permanently installing in live music, nightclub and bar environments where subs may have to be fitted under seating or in confined spaces.

The two custom 10" drivers feature advanced suspension mechanics that allow extremely linear voice coil travel even under high excursion conditions, and can move significant amounts of air to provide powerful and dynamic bass performance. Threaded rigging points are also provided on the phenolic birch plywood cabinet to enable it to be flown within suspended ceilings.



SW SUBWOOFERS

TECHNICAL SPECIFICATIONS

	SW2100A	SW2100P	SW212A 
Configuration	1 x 21" (4"VC)	1 x 21" (4"VC)	2 x 12" (3.5"VC)
Frequency Response	34 Hz - 180 Hz -6dB (processed)	34 Hz - 180 Hz -6dB (processed)	38 Hz - 220 Hz ±3dB (processed)
Nominal Impedance	N/A	4 Ω	N/A
Max Peak SPL	138 dB SPL @ 1m	138 dB SPL @ 1m	134 dB SPL @ 1m *
Power Handling	N/A	1600 W (AES) 3200 W (Prgm)	N/A
Amplifier Power Output	2000 W + 2000W Class D (continuous Pwr.)	N/A	1400W+1400W Class D (countinuous Pwr.)
Coverage Angle @ -6dB points	N/A	N/A	N/A
Dimensions (WxHxD) mm / ins	511 x 554 x 770 20.1" x 21.8" x 30.3"	511 x 554 x 770 20.1" x 21.8" x 30.3"	710 x 354 x 700 27.9" x 13.9" x 27.6"
Net Weight	61 kg / 134.2 lbs	56 kg / 123.4 lbs	43.5 kg. / 95.9 lbs
Enclosure	18mm phenolic birch plywood	18mm phenolic birch plywood	18mm phenolic birch plywood
Finish	Black or White textured paint	Black or White textured paint	Black textured paint
Rigging	N/A	N/A	N/A
Mains Connectors	PowerCON™ TRUE1	N/A	PowerCON™ TRUE1

The ess
of

	SW218XA	SW218XP	SW36XFA	SW36XFP
Configuration	2 x 18" (4"VC) Tetracoil Technology	2 x 18" (4"VC) Tetracoil Technology	2 x 18" (4"VC) Tetracoil Technology	2 x 18" (4"VC) Tetracoil Technology
Frequency Response	30 Hz - 92 Hz ±3dB (processed)	30 Hz - 92 Hz ±3dB (processed)	36 Hz - 100 Hz ±3dB (processed)	36 Hz - 100 Hz ±3dB (processed)
Nominal Impedance	N/A	8 Ω + 8 Ω	N/A	8 Ω + 8 Ω
Max Peak SPL	143 dB SPL @ 1m	143 dB SPL @ 1m	143 dB SPL @ 1m	143 dB SPL @ 1m
Power Handling	N/A	1800+1800 W (AES) 3600+3600 W (Prgm)	N/A	1800+1800 W (AES) 3600+3600 W (Prgm)
Amplifier Power Output	2000 W + 2000W Class D (continuous Pwr.)	N/A	2000 W + 2000W Class D (continuous Pwr.)	N/A
Coverage Angle @ -6dB points	N/A	N/A	N/A	N/A
Dimensions (WxHxD) mm / ins	1215 x 590 x 950 47.9" x 23.2" x 37.4"	1215 x 590 x 950 47.9" x 23.2" x 37.4"	745 x 825 x 600 29.3" x 32.5" x 23.6"	745 x 825 x 600 29.3" x 32.5" x 23.6"
Net Weight	121.2 kg / 267.2 lbs	114 kg / 251.3 lbs	91.2 kg / 201.1 lbs	87.4 kg / 192.7 lbs
Enclosure	18mm phenolic birch plywood	18mm phenolic birch plywood	15mm phenolic birch plywood	15mm phenolic birch plywood
Finish	Black textured paint	Black textured paint	Black or White textured paint	Black or White textured paint
Rigging	N/A	N/A	Integrated system	Integrated system
Mains Connectors	PowerCON™ TRUE1	N/A	PowerCON™ TRUE1	N/A

ence
Sound

SW SUBWOOFERS

TECHNICAL SPECIFICATIONS

	SW1800A	SW215A	SW215FA	SW215P
Configuration	2 x 18" (3"VC)	2 x 15" (3"VC)	2 x 15" (3"VC)	2 x 15" (3"VC)
Frequency Response	36 Hz - 115 Hz ±3dB (processed)	39 Hz - 120 Hz ±3dB (processed)	39 Hz - 120 Hz ±3dB (processed)	39 Hz - 120 Hz ±3dB (processed)
Nominal Impedance	N/A	N/A	N/A	8 Ω + 8 Ω
Max Peak SPL	139 dB SPL @ 1m	139 dB SPL @ 1m	139 dB SPL @ 1m	139 dB SPL @ 1m
Power Handling	N/A	N/A	N/A	700+700 W (AES) 900+900 W (Prgm)
Amplifier Power Output	1000 W + 1000W Class D (continuous Pwr.)	1000 W + 1000W Class D (continuous Pwr.)	1000 W + 1000W Class D (continuous Pwr.)	N/A
Coverage Angle @ -6dB points	N/A	N/A	N/A	N/A
Dimensions (WxHxD) mm / ins	570 x 960 x 880 22.4" x 13.8" x 34.6"	571 x 800 x 582 22.5" x 31.5" x 22.9"	571 x 800 x 582 22.5" x 31.5" x 22.9"	571 x 800 x 582 22.5" x 31.5" x 22.9"
Net Weight	70 kg / 154.3 lbs	64.5 kg / 142.2 lbs	68.5 kg / 151 lbs	61 kg / 134.5 lbs
Enclosure	15mm phenolic birch plywood	15mm phenolic birch plywood	15mm phenolic birch plywood	15mm phenolic birch plywood
Finish	Black textured paint	Black textured paint	Black or White textured paint	Black textured paint
Rigging	N/A	N/A	Integrated system	N/A
Mains Connectors	PowerCON™ TRUE1	PowerCON™	PowerCON™	N/A

The ess
of

	SW215FP	SW18P	SW18A	SW210P
Configuration	2 x 15" (3"VC)	1 x 18" (4"VC)	1 x 18" (4"VC)	2 x 10" (3"VC)
Frequency Response	39 Hz - 120 Hz ±3dB (processed)	36 Hz - 100 Hz ±3dB (processed)	36 Hz - 100 Hz -6dB (processed)	45 Hz - 100 Hz -6dB (processed)
Nominal Impedance	8 Ω + 8 Ω	8 Ω	N/A	8 Ω + 8 Ω
Max Peak SPL	139 dB SPL @ 1m	132 dB SPL @ 1m	132 dB SPL @ 1m	130 dB SPL @ 1m
Power Handling	700+700 W (AES) 900+900 W (Prgm)	800 W (AES) 1200 W (Prgm)	N/A	350+350 W (AES) 700+700 W (Prgm)
Amplifier Power Output	N/A	N/A	2000 W Class D (continuous Pwr.)	N/A
Coverage Angle @ -6dB points	N/A	N/A	N/A	N/A
Dimensions (WxHxD) mm / ins	571 x 800 x 582 22.5" x 31.5" x 22.9"	650 x 500 x 564 25.6" x 19.7" x 22.2"	650 x 500 x 564 25.6" x 19.7" x 22.2"	650 x 310 x 410 25.6" x 12.2" x 16.1"
Net Weight	65 kg / 143.3 lbs	40 kg / 88.2 lbs	42.5 kg / 93.7 lbs	30 kg / 66 lbs
Enclosure	15mm phenolic birch plywood	15mm phenolic birch plywood	15mm phenolic birch plywood	15mm phenolic birch plywood
Finish	Black or White textured paint	Black textured paint	Black textured paint	Black or White textured paint
Rigging	Integrated system	N/A	N/A	N/A
Mains Connectors	N/A	N/A	PowerCON™ TRUE1	N/A

ence
Sound



KEY FEATURES

- Arrayable Point Source loudspeakers
- Wide range of models for a variety of applications
- Constant coverage and excellent directivity control
- Near-field and mid-field sound reinforcement applications
- Passive and bi-amped format
- High quality, low distortion drivers
- Asymmetric dispersion pattern
- Audiophile-grade passive crossover networks
- Multiple integral rigging points

ED point source systems are designed for indoor and outdoor sound reinforcement applications ranging from clubs, bars and restaurants to theatres, live music venues, houses of worship and themed environments. Passive ED Series loudspeaker systems are easy to set up and simple to operate, while the bi-amped models offer a higher level of performance and system control.



ED POINT SOURCE

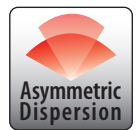
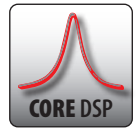

ED150A / ED150P

15" Two-way Full Range Loudspeaker

ED150A • Self-powered

ED150P • Passive

ED150PWH • Passive white textured paint

The ED150 A/P is a two-way full range enclosure containing a 15" LF drive unit and a 1.4" HF (VC 2.5") compression driver, providing an extended bass response. It is designed for many stand-alone sound reinforcement applications, although additional subwoofers from the AXIOM range can extend low frequency response.

The powered version is featuring an integrated Class D amplifier module with factory presets provided by the PROEL CORE digital signal processing. A pole mount socket and flush handles make the ED150A easy to transport and use in portable situations, while the integrated rigging points enable suspension in permanent installations.

The ED150 and ED120 systems feature an asymmetric HF coverage pattern, varying from 100° horizontal in the lower part of the horn for more effective near field coverage, and narrowing to 60° horizontal at the top of the horn for more focused coverage in the far field.

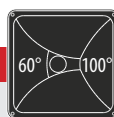
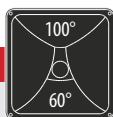

The result is more accurate coverage of a typical auditorium than is possible with a fixed horizontal coverage device. **The HF horn is also rotatable through 90° by simply removing four screws and re-aligning the horn**, so that coverage can also be optimised for stage monitor use, maintaining the best coverage pattern for performers both near to and further away from the monitor.



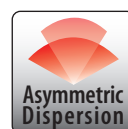
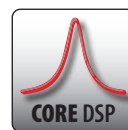

ED120A / ED120P

12" Two-way Full Range Loudspeaker

ED120A • Self-powered

ED120P • Passive

ED120PWH • Passive white textured paint

The ED120 A/P is a two-way full range enclosure containing a 12" LF drive unit and a 1.4" HF (VC 2.5") compression driver, providing an extended bass response. It is designed for many stand-alone sound reinforcement applications, although additional subwoofers from the AXIOM range can extend low frequency response.

The powered version is featuring an integrated Class D amplifier module with factory presets provided by the PROEL CORE digital signal processing. A pole mount socket and flush handles make the ED120 easy to transport and use in portable situations, while the integrated rigging points enable suspension in permanent installations.

ED120A - ED150A



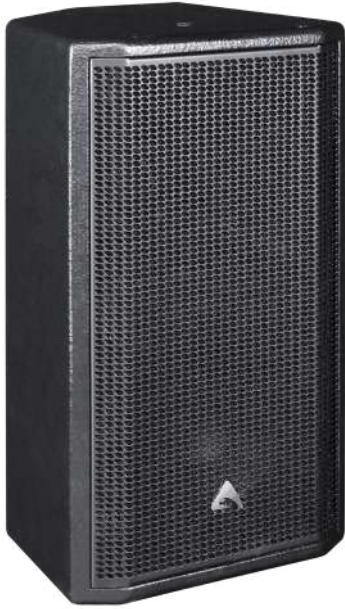

ED80P



Passive 8" Two-way Full Range Loudspeaker

ED80PWH • white textured paint

The ED80P consists of an 8" LF drive unit and a 1" HF compression driver loaded by an asymmetric HF horn in a compact enclosure, designed for many multipurpose sound reinforcement activities ranging from corporate audio-visual to permanent installations for bars and restaurants, theatres, live music venues, retail and leisure outlets, and houses of worship.

This versatile loudspeaker can also be used as a low profile stage monitor with its 35° tapered side, and in this situation the HF horn can be rotated to maintain the best coverage pattern for performers both near to and further away from the monitor.



ED60P



Passive 6" Two-way Full Range Loudspeaker

ED60PWH • white textured paint

The ED60P shares all of the characteristics of the larger ED80P but in an unobtrusive and more compact format. It is designed for a multitude of near field applications such as theatre underbalcony fill, stage front fill, delay speaker, bar and restaurant audio, and discreet stage monitor.

A pole mount socket and recessed flush handle make this a very versatile loudspeaker in both portable and permanently installed applications.

The ED80P and ED60P feature an asymmetric HF coverage pattern, which provides optimal coverage of typical rectangular venues, with wider dispersion at the front and narrower dispersion at the rear.

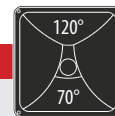
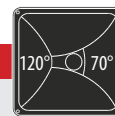
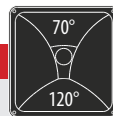

ED60P Example

The result is more accurate coverage of a typical auditorium than is possible with a fixed horizontal coverage device. **The HF horn is also rotatable through 90° by simply removing four screws and re-aligning the horn**, so that coverage can also be optimised for a multitude of different usage.

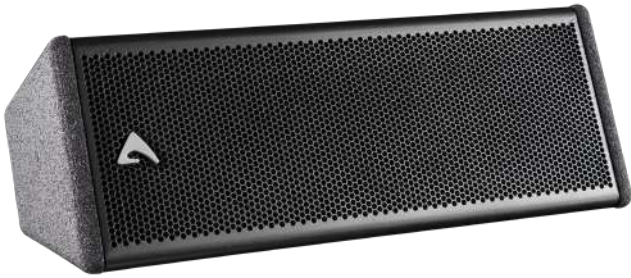

ED25P



Dual 5.25" Passive Full Range Loudspeaker

ED25PWH • white textured paint

Designed for near-field sound reinforcement applications such as television, stage front, conferencing, theatres, and audio-visual, the ED25P is an ultra-compact passive two-way loudspeaker that can be used either on its own or in small loudspeaker arrays creating even and seamless coverage. Its two 5.25" woofers and high frequency dome tweeter with Spherical Wave Guide Horn are arranged in a WTW linear enclosure configuration to give a wide dispersion pattern that works well in fixed installations using a minimal number of units. The cabinet is trapezoidally shaped, and also asymmetrical, and this profile not only allows the assembly of small clusters using the integral flypoints, but also enables it to be suspended horizontally very close to a ceiling or placed on a stage front as a low profile monitor.



ED23P MKII



Dual 3.5" Passive Full Range Loudspeaker

ED23PMKIIWH • white textured paint

The ED23P passive full range loudspeaker fulfils all of the applications for which the larger ED25P is suited, but does so from an even more compact cabinet housing two 3.5" woofers and a high frequency dome tweeter mounted on a Spherical Wave Guide Horn. The WTW driver arrangement provides a wide dispersion pattern that allows widely spaced units to cover large spaces with high quality background sound. Due to its very low profile, the ED23P is an ideal stage lip monitor, and especially useful for fashion show catwalks where it can unobtrusively provide alternate inwards / outwards coverage for both audience and presenters.



ED POINT SOURCE

TECHNICAL SPECIFICATIONS

	ED150A	ED150P	ED120A	ED120P
Configuration	1 x 15" (3"VC) LF 1 x 1.4" (2.4"VC) HF	1 x 15" (3"VC) LF 1 x 1.4" (2.4"VC) HF	1 x 12" (3"VC) LF 1 x 1.4" (2.4"VC) HF	1 x 12" (3"VC) LF 1 x 1.4" (2.4"VC) HF
Frequency Response	50 Hz - 17kHz -6dB (processed)	50 Hz - 17kHz -6dB	65 Hz - 17kHz -6dB (processed)	65 Hz - 17kHz -6dB
Nominal Impedance	N/A	8 Ω	N/A	8 Ω
Max Peak SPL	128 dB SPL @ 1m	128 dB SPL @ 1m	128 dB SPL @ 1m	128 dB SPL @ 1m
Power Handling	N/A	680 W (AES) 1360 W (prgm)	N/A	680 W (AES) 1360 W (prgm)
Amplifier Power Output	900 W + 300W Class D (continuous Pwr.)	N/A	900 W + 300W Class D (continuous Pwr.)	N/A
Coverage Angle @ -6dB points	60°-100° H x 60° V	60°-100° H x 60° V	60°-100° H x 60° V	60°-100° H x 60° V
Dimensions (WxHxD) mm / ins	450 x 765 x 400 17.7" x 30.1" x 15.7"	450 x 765 x 400 17.7" x 30.1" x 15.7"	360 x 610 x 310 14.2" x 24" x 12.2"	360 x 610 x 310 14.2" x 24" x 12.2"
Net Weight	26 kg / 57.3 lbs	25 kg / 55.1 lbs	19 kg / 41.8 lbs	18 kg / 39.6 lbs
Enclosure	15mm phenolic birch plywood	15mm phenolic birch plywood	15mm phenolic birch plywood	15mm phenolic birch plywood
Finish	Black textured paint	Black or White textured paint	Black textured paint	Black or White textured paint
Rigging	Rigging points optional brackets	Rigging points optional brackets	Rigging points optional brackets	Rigging points optional brackets
Mains Connectors	PowerCON™	N/A	PowerCON™	N/A

	ED80P	ED60P	ED25P	ED23PMKII
Configuration	1 x 8" (2"VC) LF 1 x 1" (1"VC) HF	1 x 6" (2"VC) LF 1 x 1" (1"VC) HF	2 x 5.25" LF 1 x Dome Tweeter	2 x 3.5" LF 1 x Dome Tweeter
Frequency Response	75 Hz - 18kHz -6dB	85 Hz - 18kHz -6dB	125 Hz - 20kHz -6dB	200 Hz - 20kHz -6dB
Nominal Impedance	8 Ω	16 Ω	16 Ω	32 Ω
Max Peak SPL	124 dB SPL @ 1m	114 dB SPL @ 1m	116 dB SPL @ 1m	112 dB SPL @ 1m
Power Handling	280 W (AES) 560 W (Prgm)	100 W (AES) 200 W (Prgm)	100 W (AES) 200 W (Prgm)	70 W (AES) 140 W (Prgm)
Amplifier Power Output	N/A	N/A	N/A	N/A
Coverage Angle @ -6dB points	60°-120° H x 55° V	70°-120° H x 60° V	80° H x 65° V	80° H x 65° V
Dimensions (WxHxD) mm / ins	250 x 450 x 230 9.8" x 17.7" x 9.1"	210 x 390 x 190 8.3" x 15.3" x 7.5"	176 x 460 x 190 6.9" x 18.1" x 7.5"	138 x 320 x 198 5.4" x 12.6" x 7.8"
Net Weight	8 kg / 17.6 lbs	5 kg / 11 lbs	7 kg / 15.4 lbs	6.4 kg / 14.1 lbs
Enclosure	15mm phenolic birch plywood	15mm phenolic birch plywood	15mm phenolic birch plywood	15mm phenolic birch plywood
Finish	Black or White textured paint	Black or White textured paint	Black or White textured paint	Black or White textured paint
Rigging	Rigging points optional brackets	Rigging points optional brackets	Rigging points optional brackets	Rigging points optional brackets
Mains Connectors	N/A	N/A	N/A	N/A

ence
Sound

QC AMPLIFIERS

AXIOM QC series amplifiers are high performance 2U rack mount models with built-in DSP, designed for powering large touring PA systems or loudspeaker systems in high-profile fixed installations.



CORE DSP platform developed by PROEL's R&D laboratories, uses one of the most advanced SHARC DSP chips available today for high quality audio applications. Thanks to its substantial processing power, the CORE DSP platform can provide the most sophisticated algorithms for enhanced speaker processing.

QC series amplifiers can be remotely controlled with PRONETAX software, which provides an intuitive user interface for control of the DSP features in the amplifier, and for monitoring of the amplifier's overall status. This allows the user access to many of the loudspeaker system's operating parameters such as equalisation, multiple delays, and individual driver protection.



Airflow is from front to rear, aided by whisper-quiet variable speed fans, and the removable dust filters are accessible from the front for easy maintenance when racked.

Based around a lightweight 2U chassis with an aluminium front panel, QC Series amplifiers are equally at home, on tour or in fixed installs



USB2CAND dual Output USB to CAN converter, allows your Personal Computer to access a PRONET network and control one or multiple QC series amplifiers using PRONETAX remote control software.





QC4.4

Four channel DSP Amplifier

QC2.4

Two channel DSP Amplifier with PFC

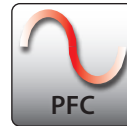
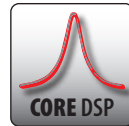
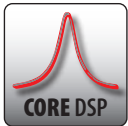

	QC4.4	QC2.4
Number of Channels	Four (single) or Two (bridged)	Two (single) or One (bridged)
Power Output @ 8 Ω	4x500 watts	2x1000 watts
Power Output @ 4 Ω	4x1000 watts	2x2000 watts
Power Output @ 8 Ω Bridged	2x2000 watts	1x4000 watts
Dimensions (W x H x D)	483x89x383mm (19x 3.5x16.2")	483x89x463mm (19x 3.5x18.2")
Net Weight	11 kg (24.3 lbs)	11 kg (24.3 lbs)

KEY FEATURES

- Digitally controlled Class D power amplifiers
- PWM output stages with variable switching frequency
- Very efficient Switch Mode Power Supply
- Extensive protection system
- 96KHz / 40bit floating point CORE processing with PRONET AX remote control
- Aluminum front panel with removable dust filters

PRONET AX
LOUDSPEAKER CONTROL SOFTWARE

PC SERIES

The PC260 digital loudspeaker controller is based on the **PROEL CORE DSP** platform and feature state-of-the-art signal processing, advanced functions a very intuitive UI, with a direct access to all the editing functions, and remote control capability. The **40bit floating point resolution** and the 24bit AD/DA converters ensure a perfect signal integrity with a dynamic range in excess of 110dB, for a superior sonic performance.

The PC260 includes a full set of functions and has 2 inputs (with the choice of **AES digital input**) and 6 outputs. Each INPUT features 5 bands of full PARAMETRIC EQ (including parametric, shelving, notch, res. HP and LP, allpass and bandpass), 28 bands of GRAPHIC EQ and 3 bands of an extremely versatile and powerful **DYNAMIC EQ**, together with a fully programmable COMPRESSOR/LIMITER and up to 600ms of delay. The OUTPUTS include any kind of crossover filters with slope up to 48dB per octave, together with 5 bands of PEQ, fully programmable COMPRESSOR/ LIMITER and up to 600ms of delay. Additional features include a 1/3 oct. **RTA** with dedicated MIC input with phantom power and a GROUPING function.

The **SPL Manager**, specifically designed for the application in fixed installations, is a very powerful tool that allows to schedule, in 4 different scenes, 16 events on each input and output, including MUTE, level change, COMPRESSOR threshold change and PRESET change. These events can be then performed automatically according to the internal clock of the unit.

PC260 can be remotely controlled with **PRONET software** through the USB port on the front panel and it can be included in a PRONET **network** using the two RJ-45 connectors on the rear panel (with the optional USB2CAN-D converter).

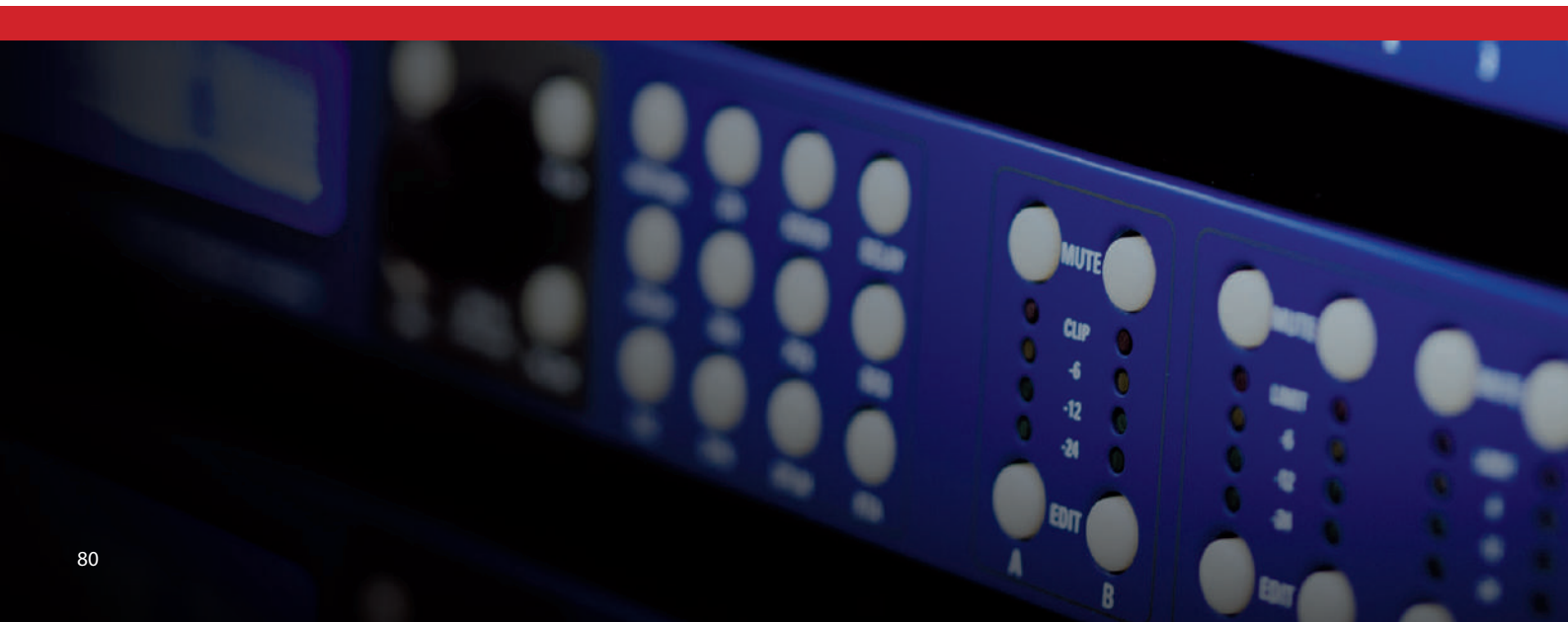



PC260

2 Inputs 6 outputs digital loudspeaker controller

- 40bit floating point resolution CORE DSP
- 24bit AD/DA converters
- 110dB dynamic range
- 5 bands of full PARAMETRIC EQ on each INPUT and OUTPUT
- 28 bands of GRAPHIC EQ on each INPUT
- 3 bands of DYNAMIC EQ on each INPUT
- Fully programmable COMPRESSOR/LIMITER on each INPUT and OUTPUT
- Up to 600ms delay time on each INPUT and OUTPUT
- Full METERING on each INPUT and OUTPUT
- RTA with dedicated MIC input
- GROUPING function
- SPL manager
- AES digital input
- PRONET remote control thru USB and network capability

USB2CAND

Dual Output USB to CAN converter, allows your Personal Computer to access a PRONET network and control one or multiple PC260 using PRONET remote control software.

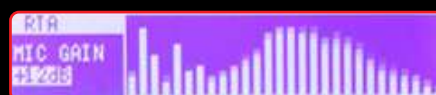
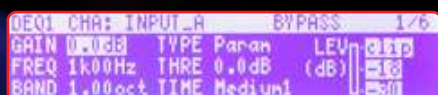
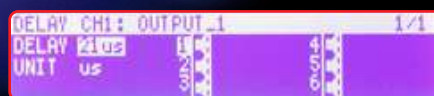
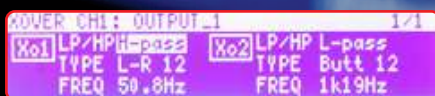

Accessories for **AX12C / AX12LF / AX6C**

KPTAX12C

Flying Bar for AX12C / AX6C

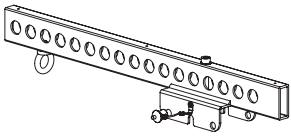

KPTFAX12C

Floor Stand for AX12C / AX6C

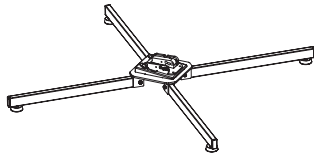

KPTFAXC

Foam floor Stand for AX12C / AX6C

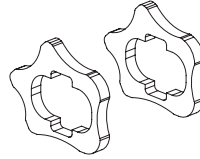

KPTPOLEAX12C

Pole adapter for AX12C / AX6C

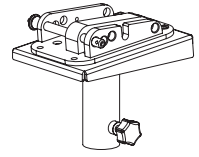

KPTWAX12C

Wall bracket for AX12C / AX6C

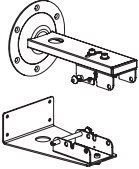

KPTWAX6C

Wall/Ceiling/Floor bracket for AX6C

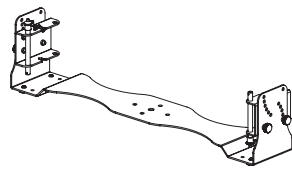

COVERAX12C

Padded Cover for AX12C/AX12LF

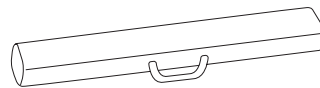

COVERAX6C

Padded Cover for AX6C

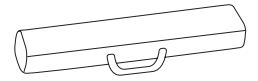

AXCASE09PT

Flight-Case for 2 x AX12C/AX12LF

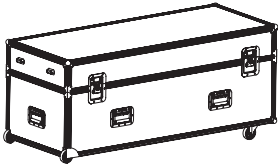

ES02500LU025

SpeakON cable 4 wire mt.0,25 for AX12C/AX6C

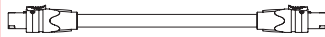

PLG714

Galvanized Steel Shackle

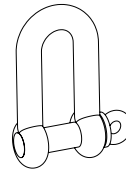

AXFEETKIT

Kit of 6. Feet for stacked Flying bar

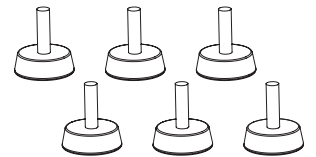

Accessories for **AX16CL / AX8CL / AX4CL**

KPTAX16CL

Flying Bar for AX16CL / AX8CL

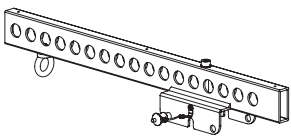

KPTSTANDAX16CL

Floor Stand for AX16CL / AX8CL

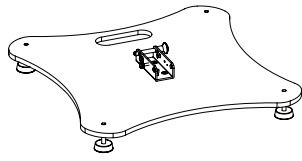

KPTFAXCL

Foam floor Stand for AX16CL / AX8CL

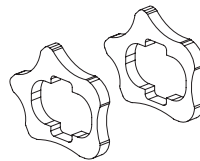

KPTPOLEAX16CL

Pole adapter for AX16CL AX8CL AX4CL

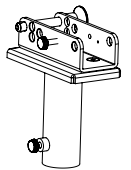

KPTWAX16CL

Wall bracket for AX16CL / AX8CL

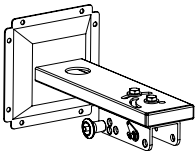

KPTWAX16CLL

Light wall bracket for AX16CL / AX8CL / AX4CL

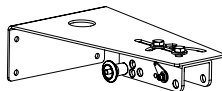

COVERAX16CL

Padded Cover for AX16CL

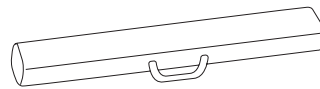

COVERAX8CL

Padded Cover for AX8CL

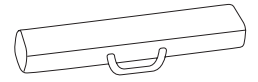

ES02500LU025

SpeakON cable 4 wire mt.0,25 for AX12C/AX6C

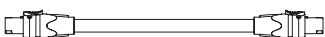

PLG714

Galvanized Steel Shackle

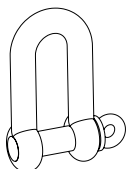

AXFEETKIT

Kit of 6. Feet for stacked Flying bar

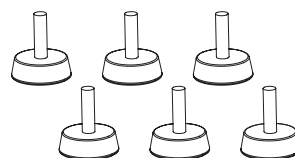

Accessories for AX1012A / AX1012P

KPTAX1012
Coupling Bar

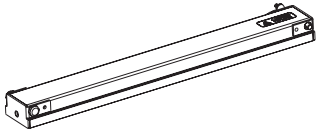

KPTAX1012H
Horizontal array flying bar

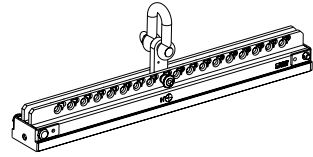

KPTAX1012T
Suspension Bar

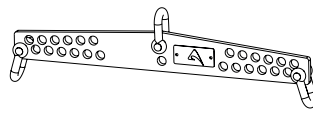

KPTAX1012V
Vertical array flying bar

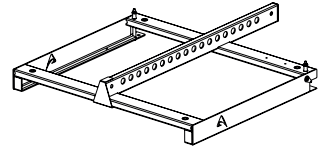

KPAX265
Pole Adapter

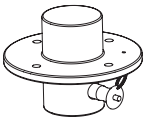

KP010
Tilt Adapter

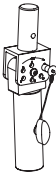

DHSS10M20
Sub-Speaker spacer with M20 screw



AXFEETKIT
Kit of 6. Feet for stacked Flying bar

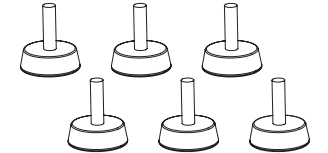

CASEAX1012V2
Flight-case for 2 x AX1012A/P



RAINCOV1012
Rain cover for AX1012A

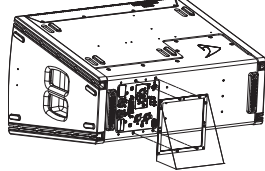

PLG714
Galvanized Steel Shackle

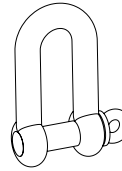

USB2CAND
Dual Output USB to CAN converter

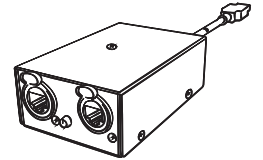

Accessories for AX2010A / AX2010P

KPTAX2012P
Flying bar for 12 AX2010 A/P

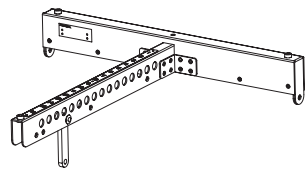

KPTSW36XF
Flying bar for AX2010 and SW36XF

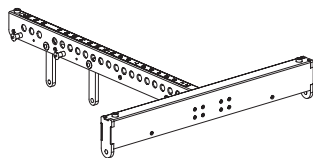

KPTAX201065
Transition frame from AX2010 to AX2065

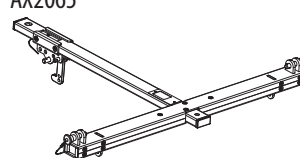

AXCASE02PT
Flight-case for 2 x AX2010

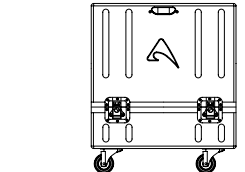

AXCASE04PT
Flight-case for 4 x AX2010

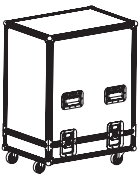

RAINCOV2010
Rain cover for Signal/control panel

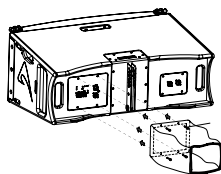

RAINCOV2010PW
Rain cover for PowerCON / Speakon connectors

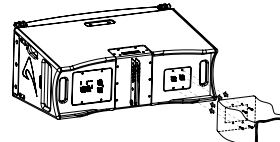

AXSKATE20P
Skate for AX2010

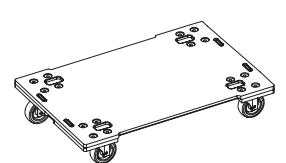

AXFEETKIT
Kit of 6. Feet for stacked Flying bar

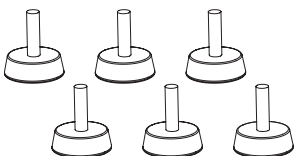

PLG716
Galvanized Steel Shackle

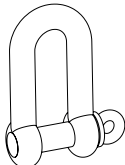

USB2CAND
Dual Output USB to CAN converter

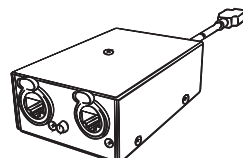

Accessories for AX2065A / AX2065P

KPTAX2065

Flying bar for 6 AX2065

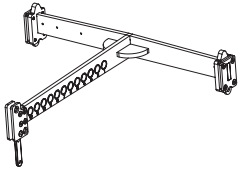

KPTSW215

Flying bar for 12 AX2065 and SW215

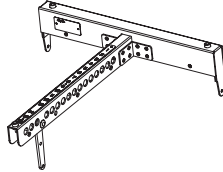

KPTAX201065

Transition frame from AX2010 to AX2065

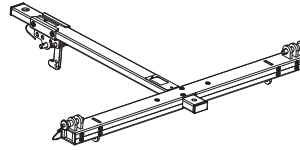

RAINCOV2065

Rain cover for AX2065

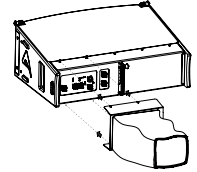

AXCASE05PT

Flight-case for 4 x AX2065 with KPTAX2065



AXCASE06PT

Flight-case for 4 x AX2065



KPAX265

Pole Adapter to screw on AX2065

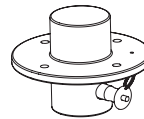

KP010

Tilt Adapter

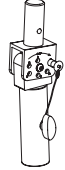

DHSS10M20

Sub-Speaker spacer with M20 screw

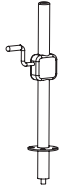

PLG714

Steel Shackle for XPTAX2065

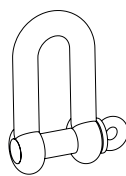

PLG716

Steel Shackle for KPTSW215

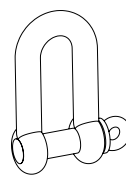

USB2CAND

Dual Output USB to CAN converter

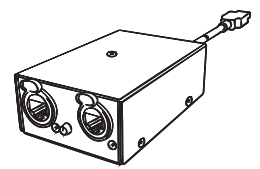

Accessories for AX800A / AX800A NEO

KPTAX800

Flying Bar for up to 4 x AX800A

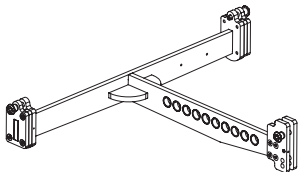

KPTAX800L

Flying Bar for up to 12 x AX800A

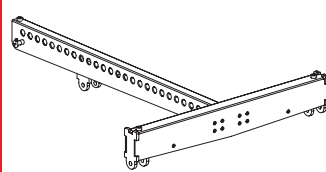

KPTAX8

Pole adapter for AX800A

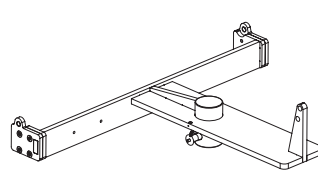

DHSS10M20

Sub-Speaker spacer with M20 screw

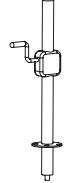

CASEAX800AV2

Flight-case for 4 x AX800A

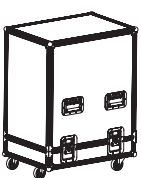

RAINCOV800

Rain cover for AX800A

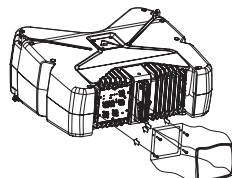

AXFEETKIT

Kit of 6. Feet for stacked Flying bar

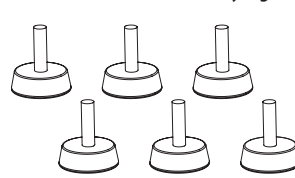

PLG714

Steel Shackle for KPTAX800

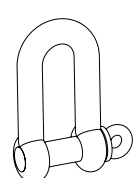

PLG716

Steel Shackle for XPTAX800L

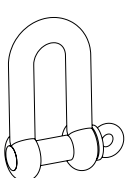

USB2CAND

Dual Output USB to CAN converter

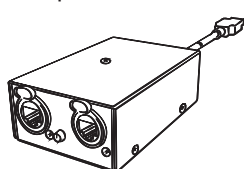

Accessories for **CX STAGE MONITORS**

CASECX15V2

Flight-case for 2 x CX15A



CASECX14V2

Flight-case for 2 x CX14A



CASECX12A

Flight-case for 2 x CX12A



COVERCX15

Padded cover for CX15A

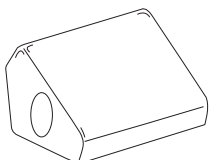

COVERCX14

Padded cover for CX14A

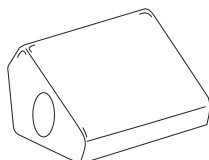

COVERCX12

Padded cover for CX12A

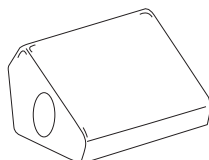

DHSS10M20

Sub-Speaker spacer with M20 screw

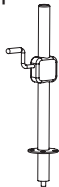

USB2CAND

Dual Output USB to CAN converter

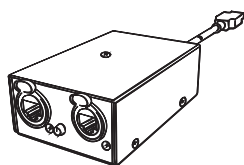

Accessories for **SW SUBWOOFERS**

COVERSW2100

Padded cover for SW2100 A/P

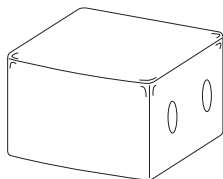

COVEREDSW218

Padded cover for SW218X A/P

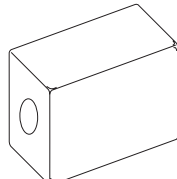

COVERSW1800

Padded cover for SW1800

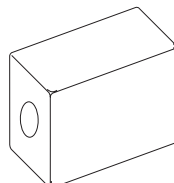

COVERSW215

Padded cover for SW215

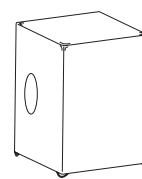

COVERSW36

Padded cover for SW36XF A/P

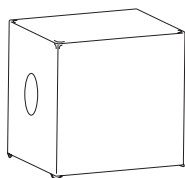

COVEREDSW18

Padded cover for SW218X A/P

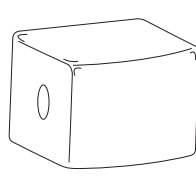

SW218XSKATE

Skate for SW218X A/P

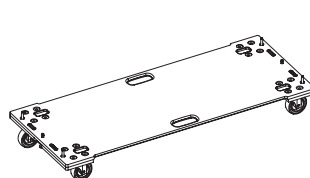

AXFEETKIT

Kit of 6. Feet for stacked Flying bar

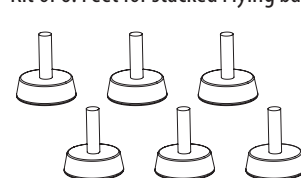

USB2CAND

Dual Output USB to CAN converter

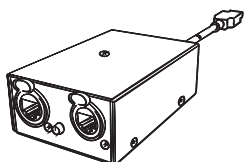

RAINCOV215

Rain cover for all Subwoofers

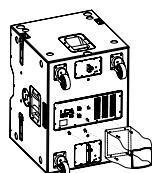

Accessories for ED POINT SOURCE

KPTED150 B/WH

Wall mounting Bracket for ED150

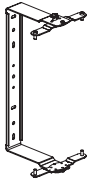

KPTED120 B/WH

Wall mounting Bracket for ED120

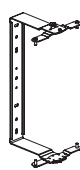

KPTED80 B/WH

Wall mounting Bracket for ED80P

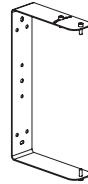

KPTED60 B/WH

Wall mounting Bracket for ED60P

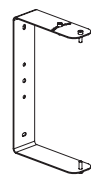

KPTED25 B/WH

Wall mounting Bracket for ED25P



KPTED23 B/WH

Wall mounting Bracket for ED23P



KPTLTP / W

Wall mounting Bracket for ED

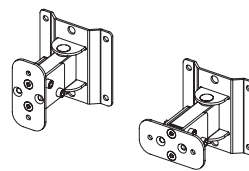

COVERED150

Padded cover for ED150

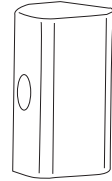

COVERED120

Padded cover for ED120P

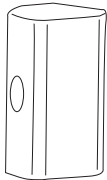

DHSS10M20

Sub-Speaker spacer with M20 screw



PLKP182ED

Pole mount adapter for ED23P, ED25P

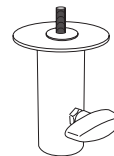

USB2CAND

Dual Output USB to CAN converter

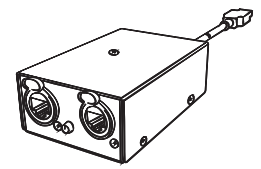



AXCAT23IE



AXIOM
is a brand of

PROEL SPA
(Worldwide Headquarters)
Via alla Ruenia, 37/43
64027 Sant'Omero (TE) - ITALY
Tel. +39 0861 81241
Fax +39 0861 887862
P.I. 00778590679
N.Reg.AEE IT 08020000002762

axiomproaudio.com

