

Product information:

The CMA162 is a cluster mounting set, allowing assembly for 2 pcs of ATEO6 speakers to any ceiling. This solution is designed for applications in large open indoor spaces where a uniform sound dispersion in all directions is required. Some typical application examples are sports facilities, gym's, large warehouses, hallways, and many more.

The CMA162 is constructed of solid steel and comes fully assembled, including pole and ceiling mount. The distance to the ceiling measures 360 mm and the pole allows cable integration, so a clean and elegant solution is offered.

The tilted mounting plates in combination with the Clevermount™ bracket structure allows optimal directional placement in any application.

The CMA series also come in a 4 speaker model (CMA164), allowing mounting of speakers in all 4 directions and are available in both Black (/B) or White (/W) colours, to match the speakers colour and blend in with the environment.

The CMA162 comes delivered excluding the loudspeakers.



Product Features:

Dimensions	179.2 x 357.5 x 140 mm (W x H x D)	
Construction	Steel	
Finish	Structured powder coating	
Max. load	10 kg (5 kg / each side)	
Suited for	ATEO6 loudspeakers	
Accessories	Included	Speaker mounting screws

Variants:

- CMA162/B - Black
- CMA162/W - White

Shipping & Ordering:

Packaging

Cardboard box

Architects' and Engineers' Specifications:

The loudspeakers shall be mounted in cluster formation to the ceiling, with two speakers facing in opposite direction of each other. The cluster bracket shall be constructed of solid steel materials, using a distance pole of 360 mm for fixation to the ceiling. The distance pole shall allow integration of the connection cable resulting in a clean and elegant solution. Fixation of the speakers shall be done to tilted mounting plates, offering optimal directional placement in combination with the Clevermount™ bracket structure. The cluster mounting set shall be available in both black & white colours to match the speakers colour and blend in with any environment. Delivery shall be fully assembled as a complete set, including fasteners for speaker fixation.

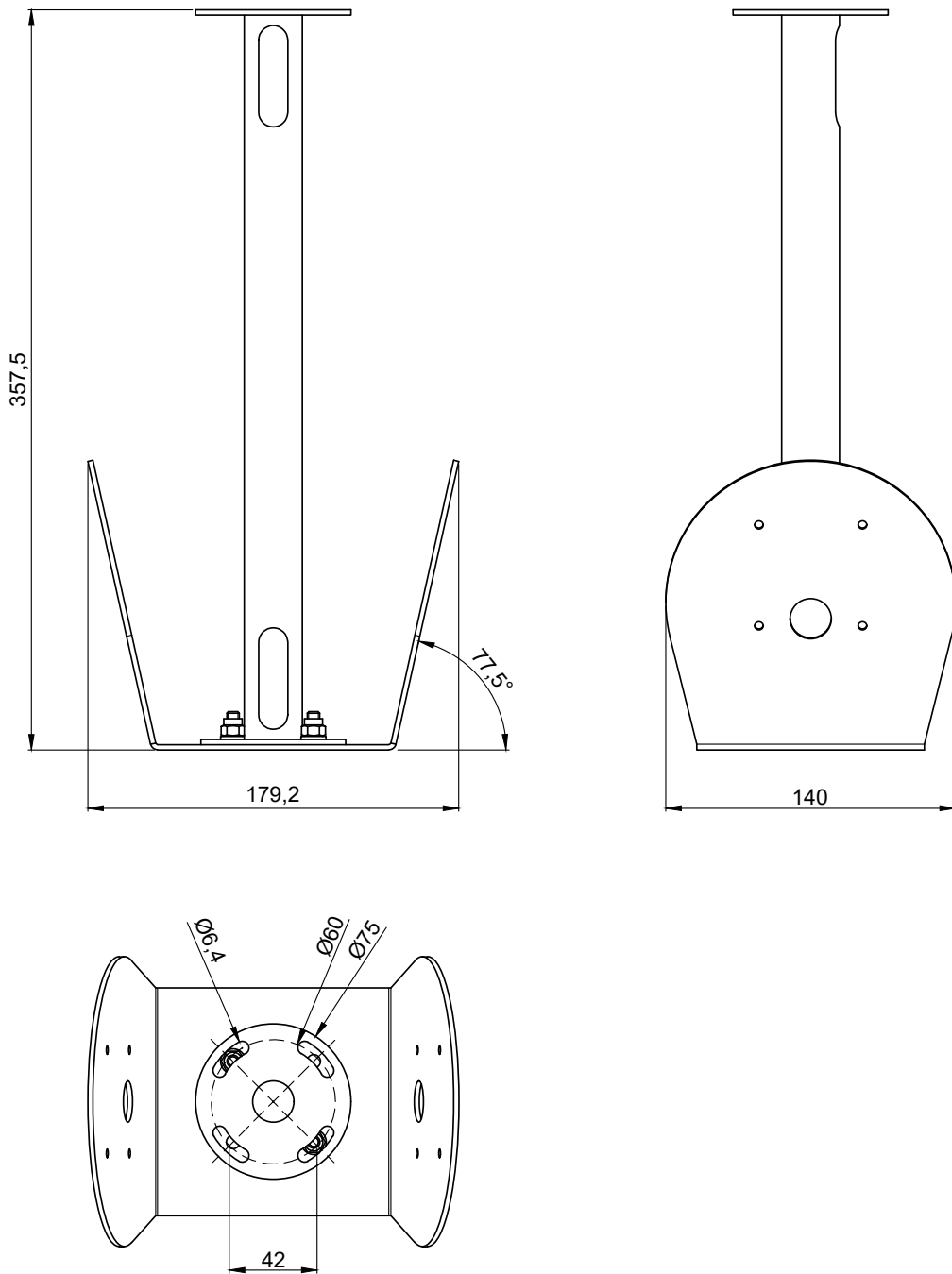

CMA162

Product description:
CLUSTER MOUNTING SET 2 x ATEO6
SPEAKER

Weight:
1,36 kg

Outer dimensions:
(w x h x d)
179,2 x 357,5 x 140

Unit height:
N/A