

DATA SHEET

Community L SERIES Beamforming Venue Horn™



LVH-909/AS

90° HORIZONTAL DISPERSION,
ACTIVE STANDARD, 20°, 40°, 60° VERTICAL DISPERSION,
ARRAYABLE, HIGH OUTPUT LOUDSPEAKER

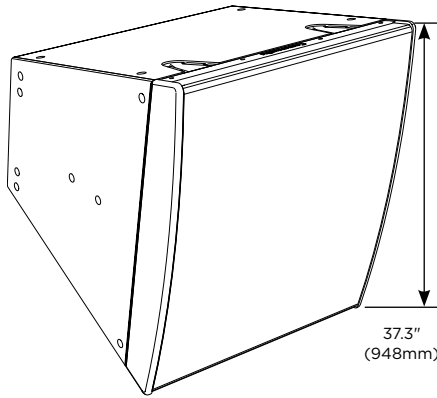

FEATURES

- Designed for extraordinary performance in large venues
- Large format, horn-loaded triaxial array maintains pattern control to 400 Hz
- Colinear manifold for HF and MF beamforming
- Indoor or Outdoor weather-resistant models
- EN54-24 and ISO 7240-24 certification

TECHNICAL SPECIFICATIONS¹

Operating Mode	Multi-Amplifier with FIR DSP Beamforming			
Operating Environment	Indoor or Outdoor Direct Exposure			
Operating Range (-10 dB) ²	50 Hz to 20 kHz			
Nominal Beamwidth	Horizontal: 90° Vertical: 60°, 40°, 20° Symmetrical (user selectable presets)			
Transducers	LF: 4 x 12" (300 mm) with 3" (75 mm) CCAW voice coil, inherently weather-resistant cone in cast aluminum chassis MF: 3 x M200, 2" (51 mm) exit, ketone polymer diaphragm, compression driver HF: 4 x 1.5" (38 mm) CCAW voice coil, 1" (25 mm) exit, ketone polymer diaphragm, compact neodymium compression driver			
Nominal Continuous Power Handling ³	LF (per pair)	87 V (950 W, 8 Ω)		
	MF 1 MF 2	26 V (130 W, 5 Ω 65 W, 10 Ω)		
	HF (per pair)	23 V. (65 W, 8 Ω)		
Nominal Maximum SPL (Processed) ⁴	20° pattern	134dB continuous	140 dB peak	
	40° pattern	133dB continuous	139 dB peak	
	60° pattern	134dB continuous	140 dB peak	
Rated Continuous Voltage ⁵	LF	50.1 V (34 dBV)		
	MF	20.0 V (26 dBV)		
	HF	15.8 V (24 dBV)		
Rated Maximum SPL (Processed) ⁶	20° pattern	130dB continuous	142dB peak	
	40° pattern	130dB continuous	142dB peak	
	60° pattern	130dB continuous	142dB peak	
Recommended Amplifiers	LF: 2 Channels ALC-1604D (Bridge Mode) MF & HF: 4 Channels ALC-404D			
Crossover Frequencies	530 Hz, 1.84kHz			

APPLICATIONS

Stadiums · Houses of Worship · Arenas
Theaters · Ice Rinks · Auditoriums
Large multipurpose outdoor and indoor venues

DESCRIPTION

Biamp's Community L SERIES LVH-900/AS Beamforming Venue Horn™, combined with the Community Amplified Loudspeaker Controllers (ALCs), precisely tailors the directivity of each loudspeaker, or array of loudspeakers, to meet the sound requirements in any application.

Designed for exceptional performance in large venues, each LVH-909/AS (Active Standard) model consists of four 12-inch LF drivers, three Community M200 midrange compression drivers and four 1.5-inch HF compression drivers. Using patent-pending techniques, all drivers integrate into a single triaxial waveguide that fills the entire 36 x 31-inch face of the enclosure, providing pattern control to below 400 Hz. The LVH-909 offers 90° of fixed horizontal dispersion, and has presets for vertical dispersion beamforming in 60°, 40°, 20° configurations. The LVH-900 Active Standard (AS) models allow DSP settings and control of individual driver pairs to provide uniform sound to the audience areas.

Typical applications include music and speech reinforcement for large houses of worship, stadiums, theatres, and much more. Possessing advanced features, highly-focused dispersion patterns, weather-resistant construction, and most importantly sonic excellence, LVH-900 loudspeakers make installations not only fast and simple, but as functionally effective as possible.

Biamp strives to improve its products on a continual basis. Specifications are therefore subject to change without notice.

PHYSICAL

Input Connection	Lever-actuated wire clamping 4 and 8-position terminal blocks
Mounting Points	(24) M10 rigging inserts
Operation Environment	Indoor and Outdoor Outdoor: IP56 per IEC 60529 when used with the input panel and seal cup cover plates; Weather resistant to IEC 60068-2-1 Cold, IEC 60068-2-2 Dry Heat, IEC 60068-2-6 Vibration, IEC 60068-2-30 Damp Heat, cyclic, IEC 60068-2-42 SO2, and IEC 60068-2-78 Damp Heat, steady state
Dimensions H x W x D	948 mm x 797 mm x 775 mm (37.3" x 31.4" x 30.5")
Weight	113.4 kg (250 lbs) Indoor model 95.3 kg (210 lbs) Outdoor weather-resistant model
Finish	Refer to the Technical Drawing (page 5)

OPTIONS

Accessories (full list on page 6)	Splay Bracket: LVH-900SP1 Type 1; LVH-900SP2 Type 2 Indoor Frames: LVH-900AF Array frame; LVH-900PB Pull-back; LVH-900UB U-Bracket (single cabinet only) LVH-900ASPTP: MF/HF Pass-Thru Panel 3rd party rigging: Indoor & outdoor
-----------------------------------	---



Community L SERIES Beamforming Venue Horn

LVH-909/AS

90° HORIZONTAL DISPERSION,
ACTIVE STANDARD, 20°, 40°, 60° VERTICAL DISPERSION,
ARRAYABLE, HIGH OUTPUT LOUDSPEAKER

20° VERT PATTERN

AXIAL PROCESSED SENSITIVITY (dB SPL)⁷

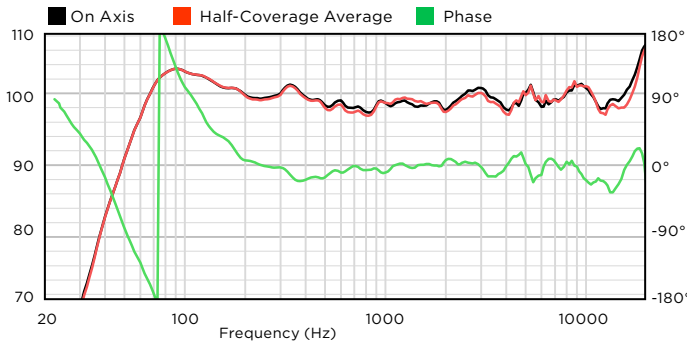

HORIZONTAL OFF-AXIS RESPONSE (dB SPL)⁸

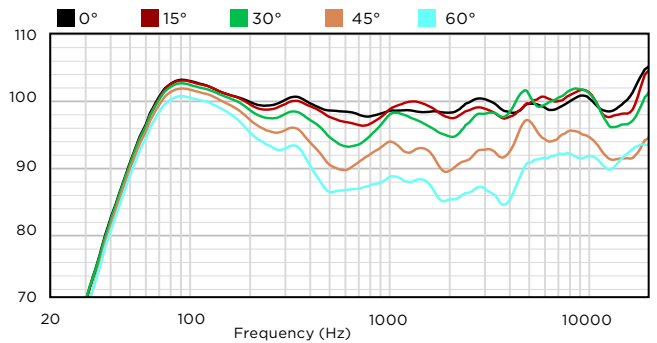

IMPEDANCE (Ω)

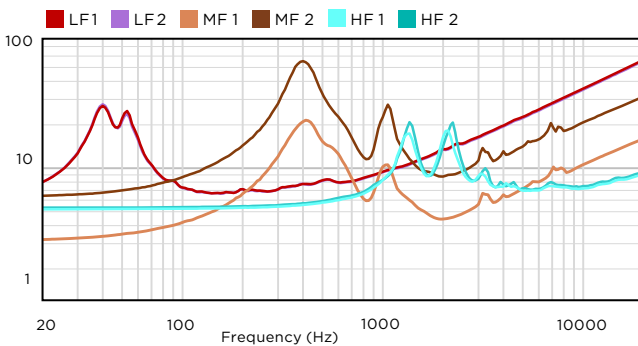

Min Impedance: (LF 1) 6.7 Ω @ 140Hz (LF 2) 6.7 Ω @ 155Hz
(MF 1) 4.4 Ω @ 1950 Hz, (MF 2) 8.7 Ω @ 1950 Hz,
(HF 1) 7.0 Ω @ 5150 Hz, (HF 2) 7.1 Ω @ 5600 Hz

VERTICAL OFF-AXIS RESPONSE (dB SPL)⁸

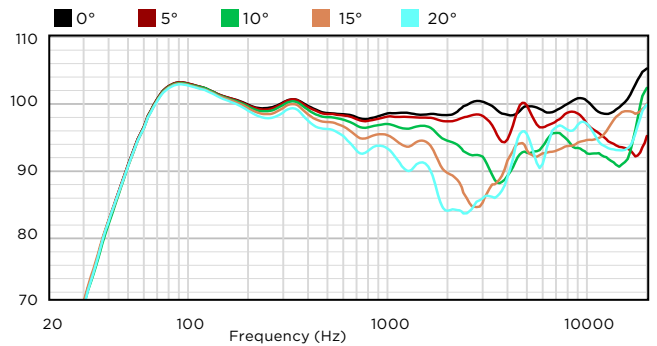

DIRECTIVITY INDEX (dB)⁹

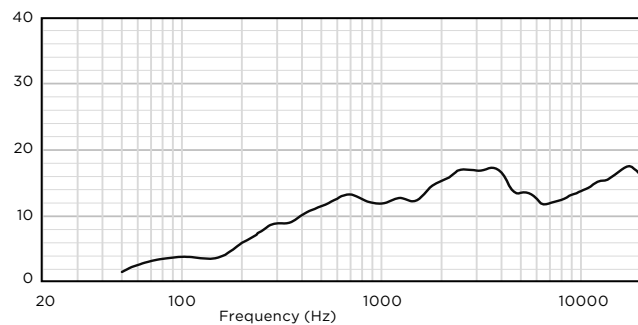

SPECIFICATIONS FOR EN54-24 (LVH-906/AS-20°)

Sensitivity (1 W, 4 m)	88 dB	
Maximum SPL (4 m)	116.2 dB	
Coverage (-6 dB) Horiz/Vert	500 Hz: 80°/60°	2 kHz: 80°/30°
	1 kHz: 95°/40°	4 kHz: 90°/20°
Rated Impedance	HF: 8 Ω; MF1: 5 Ω; MF2: 10 Ω; LF: 8 Ω	

BEAMWIDTH (degrees)¹⁰

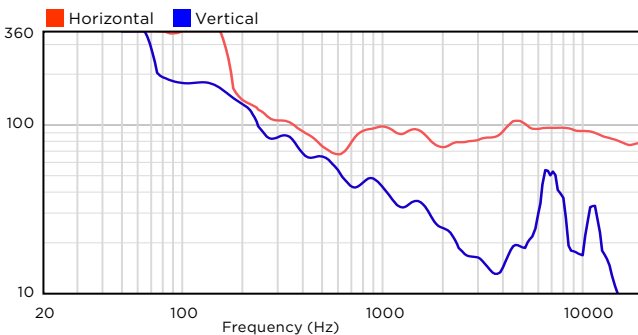

Community L SERIES Beamforming Venue Horn

LVH-909/AS

90° HORIZONTAL DISPERSION,
ACTIVE STANDARD, 20°, 40°, 60° VERTICAL DISPERSION,
ARRAYABLE, HIGH OUTPUT LOUDSPEAKER **40° VERT PATTERN**

AXIAL PROCESSED SENSITIVITY (dB SPL)⁷

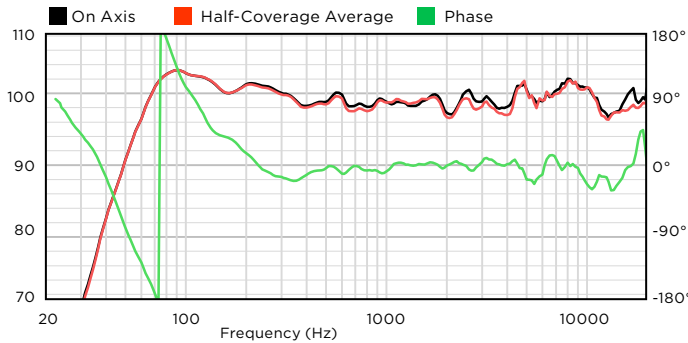

HORIZONTAL OFF-AXIS RESPONSE (dB SPL)⁸

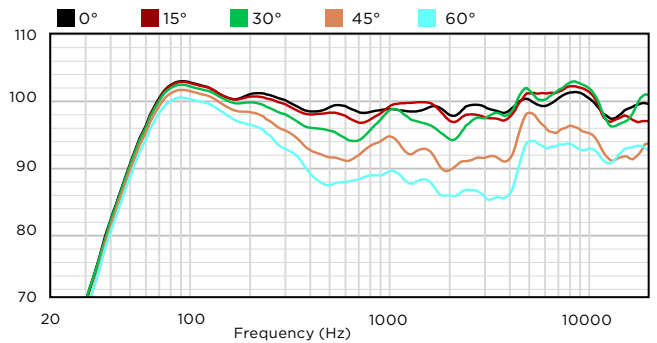

IMPEDANCE (Ω)

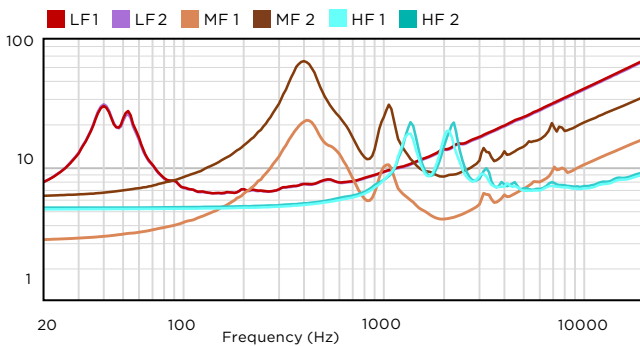

Min Impedance: (LF 1) 6.7 Ω @ 140Hz (LF 2) 6.7 Ω @ 155Hz
(MF 1) 4.4 Ω @ 1950 Hz, (MF 2) 8.7 Ω @ 1950 Hz,
(HF 1) 7.0 Ω @ 5150 Hz, (HF 2) 7.1 Ω @ 5600 Hz

VERTICAL OFF-AXIS RESPONSE (dB SPL)⁸

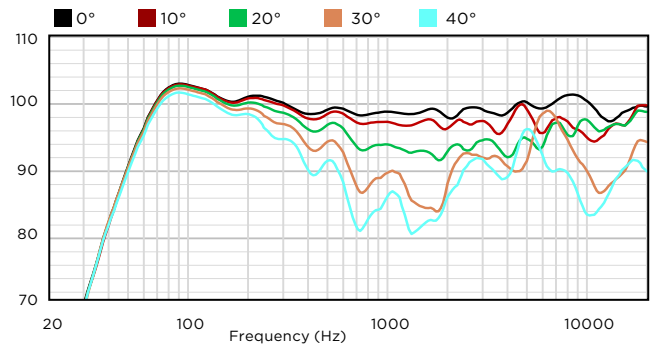

DIRECTIVITY INDEX (dB)⁹

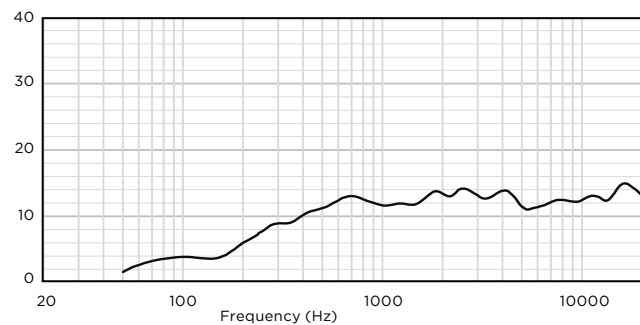

SPECIFICATIONS FOR EN54-24 (LVH-906/AS-40°)

Sensitivity (1 W, 4 m)	88 dB	
Maximum SPL (4 m)	115.9 dB	
Coverage (-6 dB) Horiz/Vert	500 Hz: 80°/65° 1 kHz: 95°/45°	2 kHz: 80°/40° 4 kHz: 85°/40°
Rated Impedance	HF: 8 Ω; MF1: 5 Ω; MF2: 10 Ω; LF: 8 Ω	

BEAMWIDTH (degrees)¹⁰

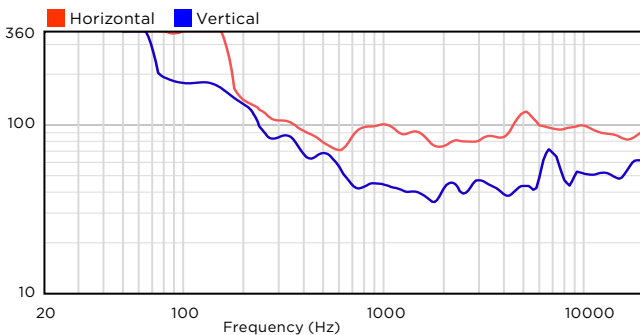

Community L SERIES Beamforming Venue Horn

LVH-909/AS

90° HORIZONTAL DISPERSION,
ACTIVE STANDARD, 20°, 40°, 60° VERTICAL DISPERSION,
ARRAYABLE, HIGH OUTPUT LOUDSPEAKER **60° VERT PATTERN**

AXIAL PROCESSED SENSITIVITY (dB SPL)⁷

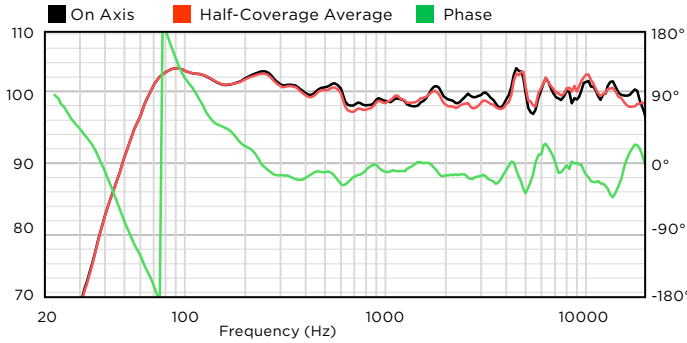

HORIZONTAL OFF-AXIS RESPONSE (dB SPL)⁸

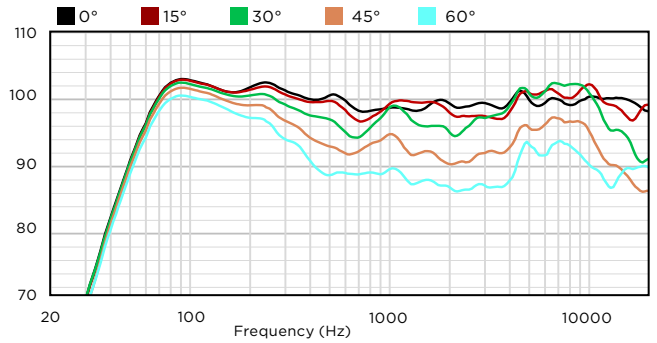

IMPEDANCE (Ω)

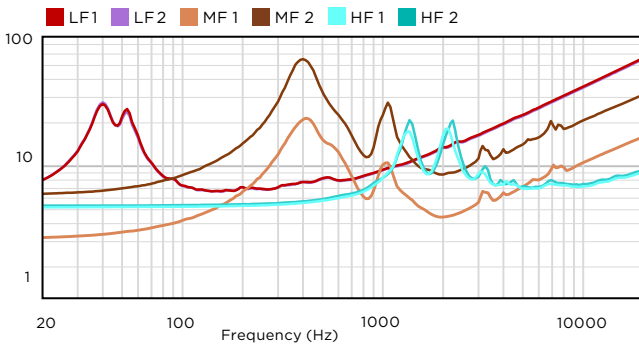

Min Impedance: (LF 1) 6.7 Ω @ 140Hz (LF 2) 6.7 Ω @ 155Hz
(MF 1) 4.4 Ω @ 1950 Hz, (MF 2) 8.7 Ω @ 1950 Hz,
(HF 1) 7.0 Ω @ 5150 Hz, (HF 2) 7.1 Ω @ 5600 Hz

VERTICAL OFF-AXIS RESPONSE (dB SPL)⁸

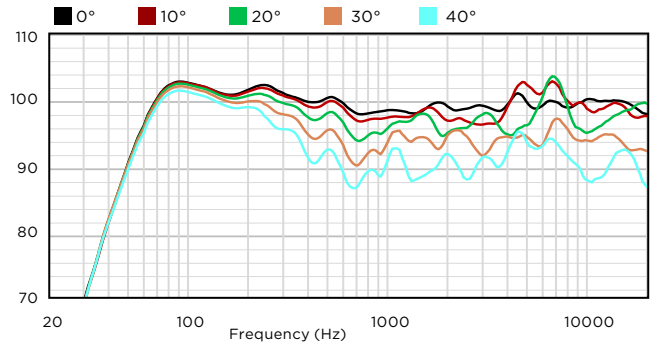

DIRECTIVITY INDEX (dB)⁹

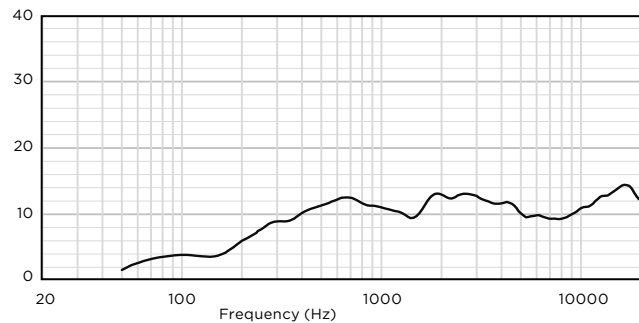

SPECIFICATIONS FOR EN54-24 (LVH-906/AS-60°)

Sensitivity (1 W, 4 m)	88 dB	
Maximum SPL (4 m)	115.2 dB	
Coverage (-6 dB) Horiz/Vert	500 Hz: 80°/65° 1 kHz: 95°/65°	2 kHz: 80°/65° 4 kHz: 90°/55°
Rated Impedance	HF: 8 Ω; MF1: 5 Ω; MF2: 10 Ω; LF: 8 Ω	

BEAMWIDTH (degrees)¹⁰

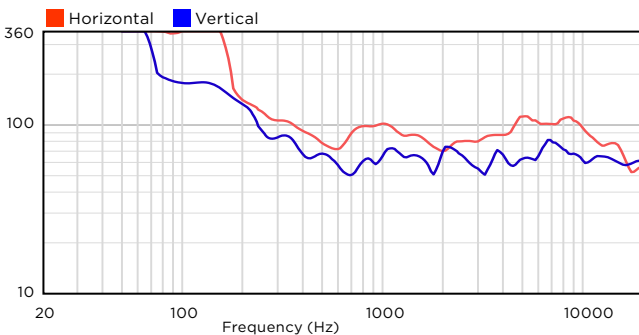

Community L SERIES Beamforming Venue Horn

LVH-909/AS

90° HORIZONTAL DISPERSION,
ACTIVE STANDARD, 20°, 40°, 60° VERTICAL DISPERSION,
ARRAYABLE, HIGH OUTPUT LOUDSPEAKER

TECHNICAL DRAWING / DIMENSIONS / FINISH

H x W x D

37.3" x 31.4" x 30.5"
(948 x 797 x 775 mm)

Unit Weight

250 lbs (113.4 kg) (Indoor)

210 lbs (95.3 kg) (Outdoor Weather-resistant)

Shipping Weight (on a pallet)

307 lbs (139.3 kg) (Indoor)

267 lbs (121 kg) (Outdoor Weather-resistant)

Enclosure Finish

Indoor: Powder-coated perforated steel (indoor) grille backed with acoustically transparent woven fabric and coated with Biamp's robust PolyCoat finish on 15mm Baltic Birch plywood enclosure

Outdoor (WR): Powder-coated marine grade aluminum grille featuring hydrophobically-treated acoustically transparent woven black fabric backing on a 15mm PolyGlas™ enclosure coated with Biamp's durable PolyCoat finish, rated for both indoor and outdoor use

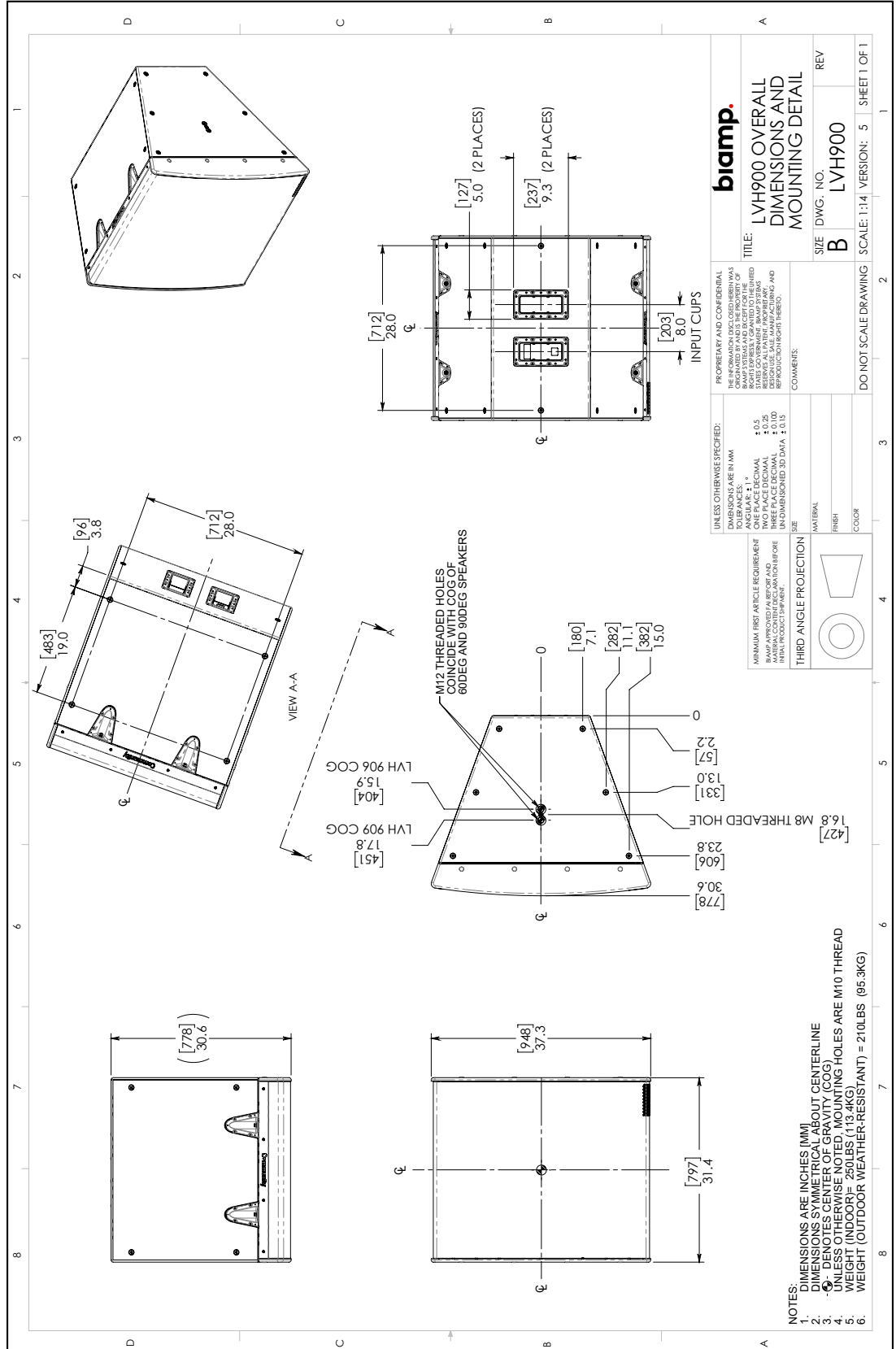

Community L SERIES Beamforming Venue Horn

LVH-909/AS

90° HORIZONTAL DISPERSION,
ACTIVE STANDARD, 20°, 40°, 60° VERTICAL DISPERSION,
ARRAYABLE, HIGH OUTPUT LOUDSPEAKER

SPLAY BRACKETS / CABINET CONNECTIONS

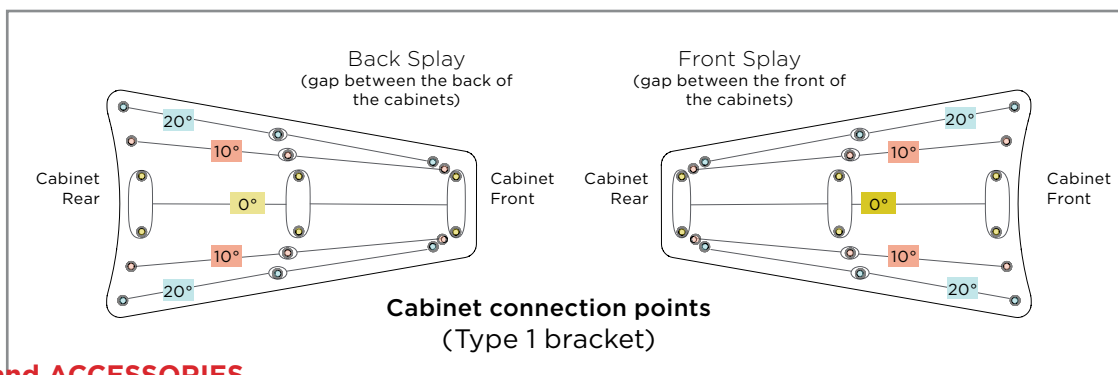
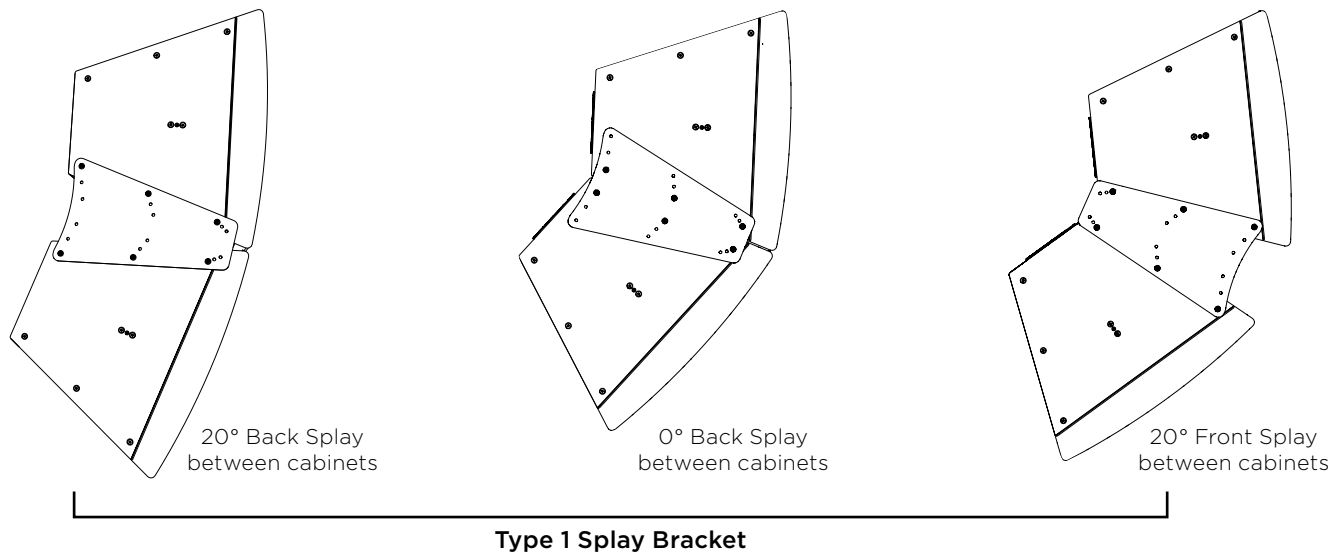

MODELS and ACCESSORIES

Models	Description
LVH-906/ASB	LVH-900 60DEG ACTIVE-STD BLK
LVH-906/ASW	LVH-900 60DEG ACTIVE-STD WHT
LVH-906WR/ASG	LVH-900WR 60DEG ACTIVE-STD GRY
LVH-906WR/ASB	LVH-900WR 60DEG ACTIVE-STD BLK
LVH-906WR/ASW	LVH-900WR 60DEG ACTIVE-STD WHT
LVH-906C/AS	LVH-900 60DEG ACTIVE-STD CTO
LVH-906WRC/AS	LVH-900WR 60DEG ACTIVE-STD CTO
LVH-909/ASB	LVH-900 90DEG ACTIVE-STD BLK
LVH-909/ASW	LVH-900 90DEG ACTIVE-STD WHT
LVH-909WR/ASG	LVH-900WR 90DEG ACTIVE-STD GRY
LVH-909WR/ASB	LVH-900WR 90DEG ACTIVE-STD BLK
LVH-909WR/ASW	LVH-900WR 90DEG ACTIVE-STD WHT
LVH-909C/AS	LVH-900 90DEG ACTIVE-STD CTO
LVH-909WRC/AS	LVH-900WR 90DEG ACTIVE-STD CTO

Accessories	Description
LVH-900AFB	LVH-900 ARRAY FRAME BLK
LVH-900AFW	LVH-900 ARRAY FRAME WHT
LVH-900PBB	LVH-900 PULL BACK BAR BLK
LVH-900PBW	LVH-900 PULL BACK BAR WHT
LVH-900UBB	LVH-900 U-BRACKET BLK
LVH-900UBW	LVH-900 U-BRACKET WHT
LVH-900SP1B	LVH SPLAY PLATE PAIR TYPE1 BLK
LVH-900SP1W	LVH SPLAY PLATE PAIR TYPE1 WHT
LVH-900SP1G	LVH SPLAY PLATE PAIR TYPE1 GRY
LVH-900SP2B	LVH SPLAY PLATE PAIR TYPE2 BLK
LVH-900SP2W	LVH SPLAY PLATE PAIR TYPE2 WHT
LVH-900SP2G	LVH SPLAY PLATE PAIR TYPE2 GRY
LVH-900ASPTP	LVH MF/HF PASS THRU PANEL

Community L SERIES Beamforming Venue Horn

LVH-909/AS

90° HORIZONTAL DISPERSION,
ACTIVE STANDARD, 20°, 40°, 60° VERTICAL DISPERSION,
ARRAYABLE, HIGH OUTPUT LOUDSPEAKER

CONNECTION DIAGRAMS

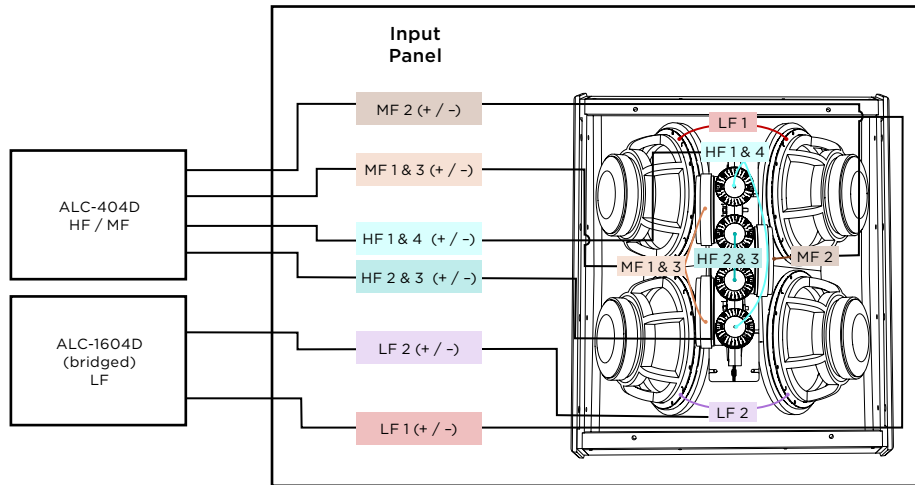

LVH-900/AS (with ALC-404D & ALC-1604D)

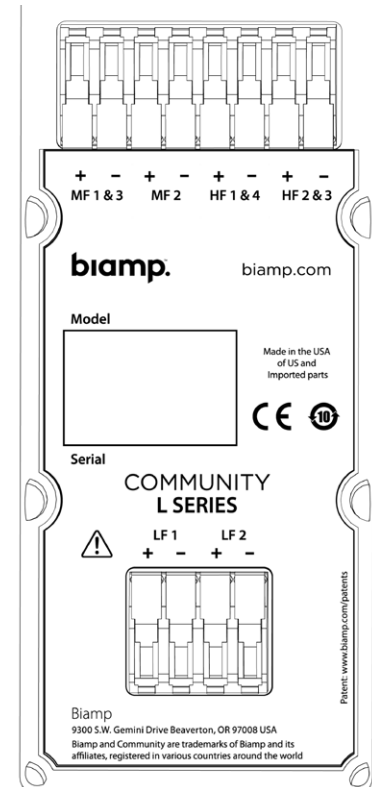

Input panel

Refer to the LVH Installation and Operation Guide for detailed wiring instructions.

NOTES

- 1. TECHNICAL SPECIFICATIONS** All measurements are performed using a time-windowed impulse response to eliminate reflections, approximating an anechoic environment, at a distance of at least 6.0 m. All acoustic specifications are rounded to the nearest whole number. An external DSP using settings provided by Biamp is required to achieve the specified performance; further performance gains can be realized using the FIR loudspeaker optimization presets available in Biamp's Community Amplified Loudspeaker Controllers (ALCs).
- 2. OPERATING RANGE** The frequency range over which the on-axis equalized/processed response remains within 10 dB of the rated sensitivity, in accordance with IEC 60268-5.
- 3. NOMINAL CONTINUOUS POWER HANDLING** The maximum continuous input voltage at the stated nominal impedance that the system can withstand for a period of 2 hours using an IEC 60268-5 defined spectrum with recommended signal processing and protection filters.
- 4. NOMINAL MAXIMUM SPL** The SPL produced when an IEC 60268-5 signal is applied to the equalized/processed loudspeaker system, at a level which drives at least one subsection to its nominal continuous voltage limit. Referenced to a distance of 1 meter. The peak SPL represents the 2:1 (6 dB) crest factor of the IEC 60268-5 test signal.
- 5. RATED CONTINUOUS VOLTAGE** The maximum continuous input voltage for the system that results in no more than a 3 dB change in the system's response during operation.
- 6. RATED MAXIMUM SPL** The SPL produced when a typical program material signal is applied to the equalized/processed loudspeaker system, at a level which drives at least one subsection to its rated continuous voltage limit. Referenced to a distance of 1 meter. The peak SPL represents the 4:1 (12 dB) crest factor of the program signal.
- 7. AXIAL PROCESSED SENSITIVITY** The variation in acoustic output level with frequency for a 2.83 V, swept-sine signal using the recommended signal processing. Referenced to 1 meter. The on-axis magnitude and phase responses, as well as the average magnitude response, calculated over one-half of the nominal coverage angles, are shown. The responses have 1/6 octave smoothing applied.
- 8. HORIZONTAL/VERTICAL OFF-AXIS RESPONSES** The loudspeaker's magnitude response at various off-axis angles using the recommended signal processing in the operating mode which utilizes the largest number of individually amplified pass bands. The responses have 1/3 octave smoothing applied.
- 9. DIRECTIVITY INDEX** The ratio of the on-axis SPL to the mean SPL at the same distance for all points within the measurement sphere for each given frequency; expressed in dB. The responses have 1/3 octave smoothing applied.
- 10. BEAMWIDTH** The included angle between the -6 dB points in the polar response of the loudspeaker when driven in the operating mode which utilizes the largest number of individually amplified pass bands. The responses have 1/3 octave smoothing applied.

Data presented on this spec sheet represents a selection of the basic performance specifications for the model. These specifications are intended to allow the user to perform a fair, straightforward evaluation and comparison with other loudspeaker spec sheets. For a detailed analysis of this loudspeaker's performance, please download the GLL file and/or the CLF file from our website. ([LVH-900_GLL](#))

CAUTION: Installation of loudspeakers should only be performed by trained and qualified personnel. It is strongly recommended that a licensed and certified professional structural engineer approve the mounting design.



A: 9300 S.W. Gemini Drive Beaverton, OR 97008 USA

T: +1 503.641.7287

W: www.biamp.com

COMDS-7007-2203-EN-R3