



ecler



Product Guide  
**AUDIO/VIDEO**  
2024





## About us

Since **Ecler**'s birth back in 1965, we have always developed our professional audio catalogue trying to listen to you.

Today **Ecler** still keeps this aim untouched. We understand that these days technology, quickly changing, must be a flexible tool to provide global and integral audio solutions, more than just individual products. Looking for a complete audiovisual experience, we expand our product offer introducing **Ecler** Video Systems to enhance our sound experience.

We keep focusing on innovation and design, both essential. And we spot how they really add value: amazing features combined with a user-friendly and ergonomic approach for the end-user, the non-technical character of the story, but indeed the main

one. We realize that today AV integration has become a growing and solid market, frequently encouraging companies towards a global scope, which requests for global audio partners, as we are.

A global green awareness is, happily, growing as well. We are proud of being part of this vital commitment, taking care of the planet with products designed for energy-saving and manufactured with sustainable policies.

Ecler is ready to offer you a quality audiovisual solution for every installation and integration challenge you may face up. This was the goal, and we honestly think it's been achieved.

**Ecler.** Innovating with you.

# Manufacturing process

In **Ecler** we place quality in the centre of all what we do. Quality in innovation, quality in product, quality in our customer service.

But most importantly we are always listening to our customers. Reliability is a must, which is why all **Ecler** products are designed and manufactured to provide a long, robust and reliable service life, even under extreme conditions of usage.

Our defect and failure rate is extremely low.

We test 100% of the products manufactured in-house, rather than randomly sampling production as is common in the electronics industry.

We are an ISO 9001:2015 certified manufacturing company.

## Design

Incorporating creativity, passion & technical knowledge all come together to conceive the product.

## Suppliers

For us, the respect for the ethical codes is a must, not just to forbidden substances harmful to the environment, but also the consideration of how people are treated when choosing suppliers and components.

## Circuit Insertions

For Printed board assembly we check all components are within tolerances defined by our engineers.

## Circuit Test

Once the inserted, all the boards are submitted to a vibration test and then individually checked before being assembled in their chassis.

## Assembly

Afterword we assemble the product paying real attention to even the minimum details and checking the finish and the mechanical fit of the whole assembly.

## Operating Check

All the manufactured products are connected to mains for 24 hours using working cycles to reproduce stressful conditions.

## Music

After the operating test, our specialists re-check all audio/video signals to guarantee the product is working correctly.

## Shipping

Now that the product is 100% checked and ready to be shipped globally, we use recycled packaging boxes conforms to the ISTA drop test.





# Values & philosophy

## Experience

One thing we have learned over these years is to listen to our partners to provide them with products adapted to their present and future needs in order to continue growing together. We work every day to turn shopping experiences in retail, hospitality, sports, well-being and leisure, into pleasant, unforgettable experiences.

## Quality

In **Ecler** we place quality in the centre of all what we do. Quality in innovation, quality in product, quality in our customer service. In **Ecler** we have been always committed with high quality standards which guarantee electrical safety and installations reliability, to keep on improving we use our network of partners who are continually collecting and analysing information ready to implement into future product launches.

## Innovation

Ever since **Ecler** introduced its SS 8 SON and a wide range of turntable styli in 1965, Ecler's trajectory has always revolved around the world of professional sound, as can be seen in its timeline, with innovation being an essential pillar to provide the audio-visual industry with competitive solutions ahead of their time. The EclerNet ecosystem, the WiSpeak wireless system or recently the VersaPower technology are some examples.

## Design

Innovation not only in the electronics but also in our product's external appearance with aesthetic contributions from renowned industrial designers such as Ital Design Giugiaro (AUDEO Series), Luis Eslava (VIDA Series) and Ecler's own industrial design team (NIMBO Series).

## Ergonomics

Also, since our time as renowned mixer manufacturers, the ease, simplicity of use and ergonomics of our products are another of the pillars on which our range is based today. This includes products designed to be configured by professionals and intuitively controlled by non-technical end-users, while maintaining all their exceptional performance for years of use.



**Born in Barcelona, we have been designing and manufacturing for more than 59 years, faithful to our vital code, shaping sound to create living spaces in more than 70 countries.**

## Our promises to you

### Trustful service

We have a permanent attitude to detect and satisfy your needs.

### Products living Forever

Planned obsolescence? What's that? We are creating products for long lasting performances.

### Made in Barcelona

European brand, Mediterranean dynamics and creativity, and passionate about image and sound.

### Thinking forward

We constantly creating new products and software listening to the market's requirements.

# Engineering at your service

Let us take care of everything so you don't have to worry about anything. Providing highly specialized tools to predict the best end results right from the get go and onwards to completion.



### Project location

Locations is important to understand the project scope and its goals



### Acoustic

The acoustic conditions of the space can influence the design of a sound system to ensure an optimal listening experience



### Project purpose

What are you aiming with the space: Do you want to make people dance or just enjoying some background music?



### Integrated or visible loudspeakers

A speaker may be installed in a visible location and play a prominent role or could be seamlessly integrated within overall décor



### Audio zones

You could have the necessity of playing different music programs and audio contents in different areas of your space

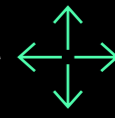

### Fixed or mobile installation

Depending on previous elements your installation could be fixed or temporary. Change the speakers location when need with our solutions

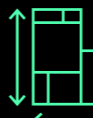

### Space dimensions

Knowing the size of your space will give us an idea of placement and number of speakers you need



### Music style and gender

Sound drives the customer's subconscious when it comes to purchasing decisions, so having the correct tune will assure your customers satisfaction



### Project schedule

We need to establish a timetable to perform the installation



### Aesthetics requirements

Your brand is unique, and we will find the best solution in our catalogue to make it pop





# Sustainability

At **Ecler** we want to create a positive impact on society, with the people who use our products, and also by ensuring that our products are manufactured in accordance with our code of ethics.

The longevity of **Ecler** products, the use of amplification technologies with higher efficiency than the competition, the incorporation of the auto-switch off system... were already at that time, strong arguments in our sustainability awareness.

ISO 14001 guarantees the commitment assumed with the protection of the environment, through the effective management of its processes associated with the activity carried out.

## Sustainable activities at Ecler

We have a multigenerational team of 6 people. All our departments are involved and committed to the company's sustainability values. We always look for alternative manufacturing materials to respect the environment.

We apply sustainable habits in our daily lives, verify our sustainable vision with suppliers and joining sustainability ecological programmes.



For almost **60 years** now, we have been helping people share music and improve communication across race and borders. Also, as responsible members of the Business Community, **we are committed to reducing and if possible, eliminating environmental impact in the creation, manufacture and distribution of our branded products.** We must work and act now, to **protect the planet for future generations.**

- Daniel González (Marketing Director)



### AV SOLUTIONS

<b>Retail</b> .....	<b>08</b>
Retail Shop .....	09
Supermarkets .....	11
<b>Corporate</b> .....	<b>12</b>
Huddle Room .....	13
Conference Room .....	15
<b>Hospitality</b> .....	<b>16</b>
Multizone Hotel .....	17
5 Zone Restaurant .....	19
Sports Bar .....	21
Beach Club .....	23
<b>Education</b> .....	<b>24</b>
Education Center .....	25
<b>Sports &amp; Wellness</b> .....	<b>26</b>
Multizone Gym .....	27
<b>House of Worship</b> .....	<b>28</b>
<b>Leisure</b> .....	<b>29</b>

### PRODUCTS AUDIO

WiSpeak (Wireless Pro Audio) .....	32
Sound Sources .....	36
Analogue Preamplifiers & Mixers .....	42
Digital Matrixes & Processors .....	46
Amplifiers .....	58
Loudspeakers .....	78
Remote Controls & Interfaces .....	106
Accessories .....	116
Accessories Compatibility Chart .....	120

### PRODUCTS VIDEO

Switchers .....	124
Matrixes .....	127
Splitters .....	129
Video Distribution over IP .....	130
4K HDBaset Extender .....	134
HDMI Extenders .....	137
Digital Control .....	138
Audio Management Devices .....	140
AV Interfaces .....	142
Accessories .....	144
VEO Specifications Table .....	146

Alphabetical Index of Products .....	150
--------------------------------------	-----





# RETAIL

RETAIL SHOP

**SUPERMARKET AUDIO**

FOOD AREA	COMMON AREA	SUPERMARKET AREA	STAFF AREA
FOOD AREA	FOOD AREA	FOOD AREA	FOOD AREA
COMM AREA	COMM AREA	COMM AREA	COMM AREA
SMKT AREA	SMKT AREA	SMKT AREA	SMKT AREA
EMER INFO	EMER INFO	EMER INFO	EMER INFO
DUON PL A	DUON PL A	DUON PL A	DUON PL A
DUON PL B	DUON PL B	DUON PL B	DUON PL B
MUTE	MUTE	MUTE	MUTE



# Retail

SUPERMARKETS / STORES / MALLS

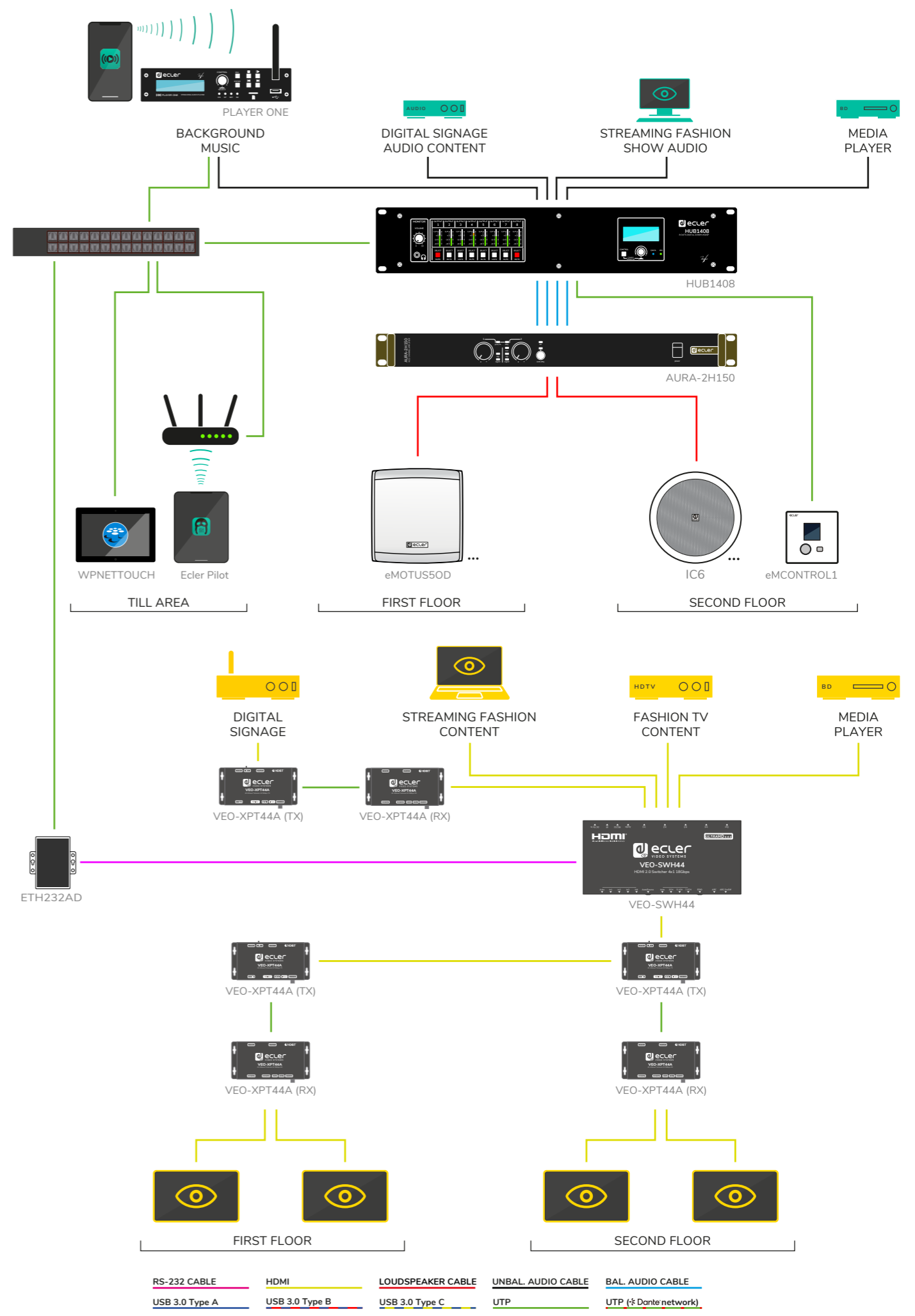



# MANGO

## RETAIL SUPERMARKETS



Mango, Madrid (Spain)

# UNITED COLORS OF BENETTON



Benetton, Madrid & Barcelona (Spain)

# Stradivarius



Stradivarius, Madrid (Spain)

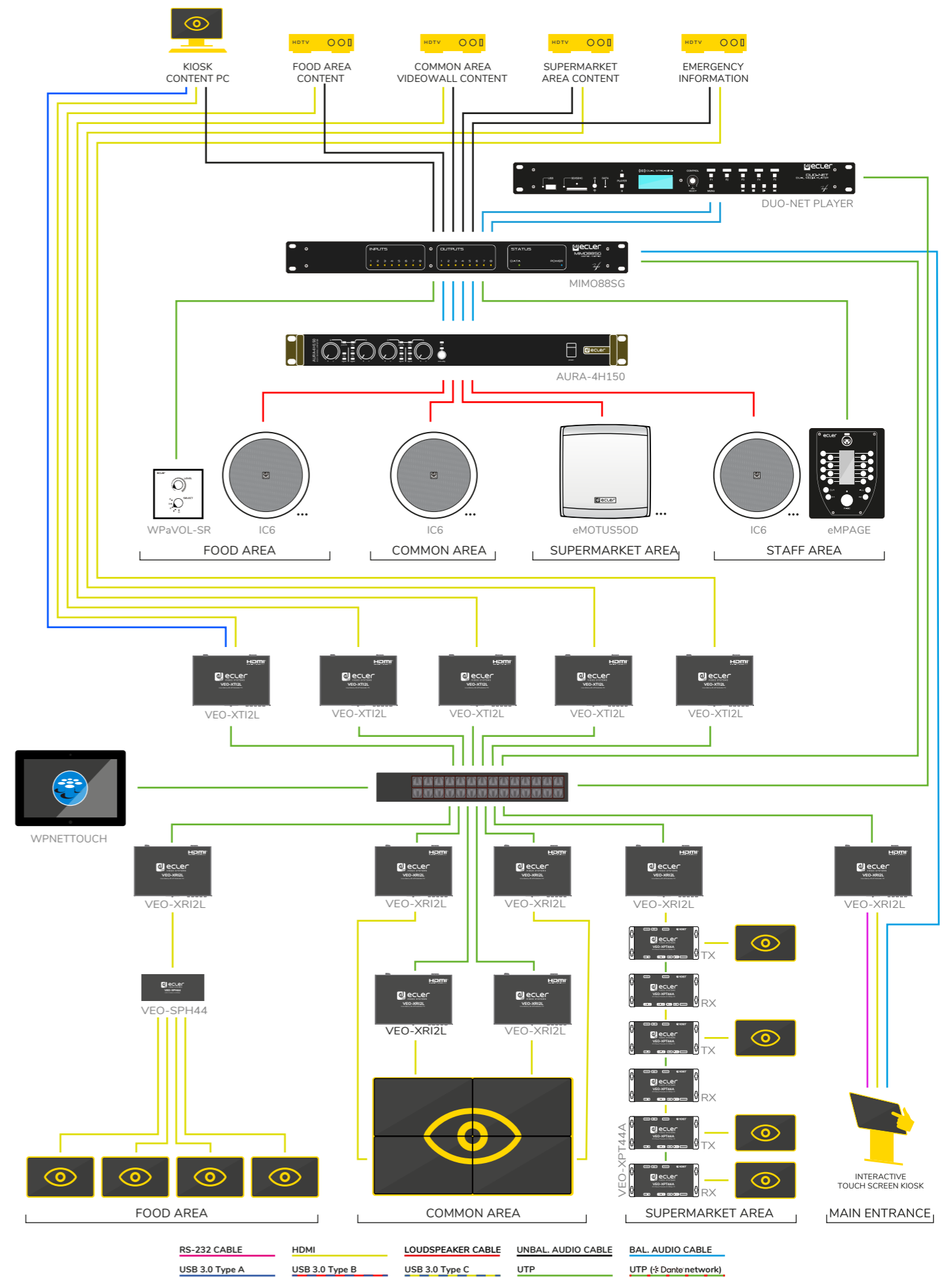





# CORPORATE

Huddle Room

# Corporate

OFFICE BUILDINGS / OFFICES, MEETING OR BOARD ROOMS / COMMON AREAS

## 1 ROOM CONFIGURATION

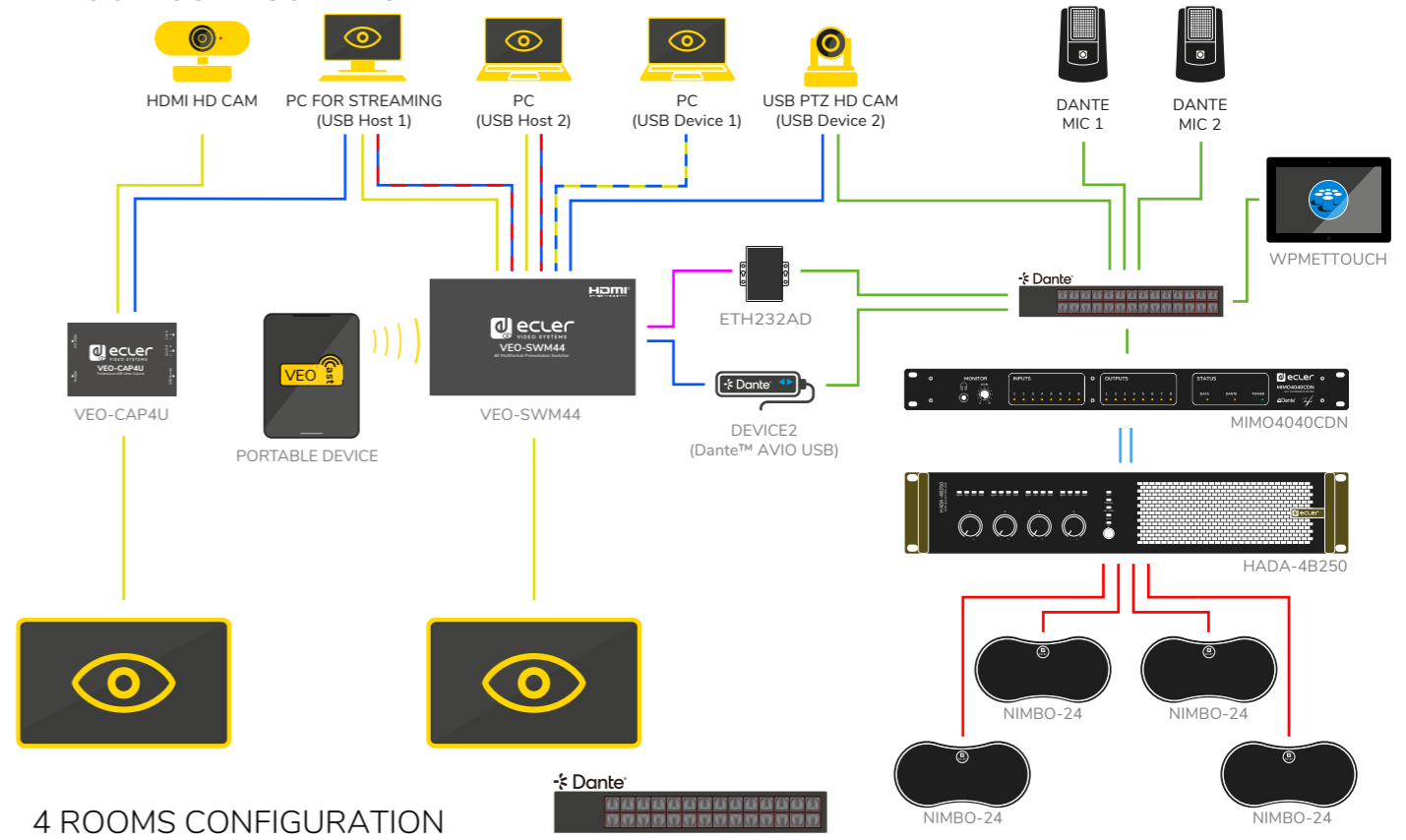

## 4 ROOMS CONFIGURATION

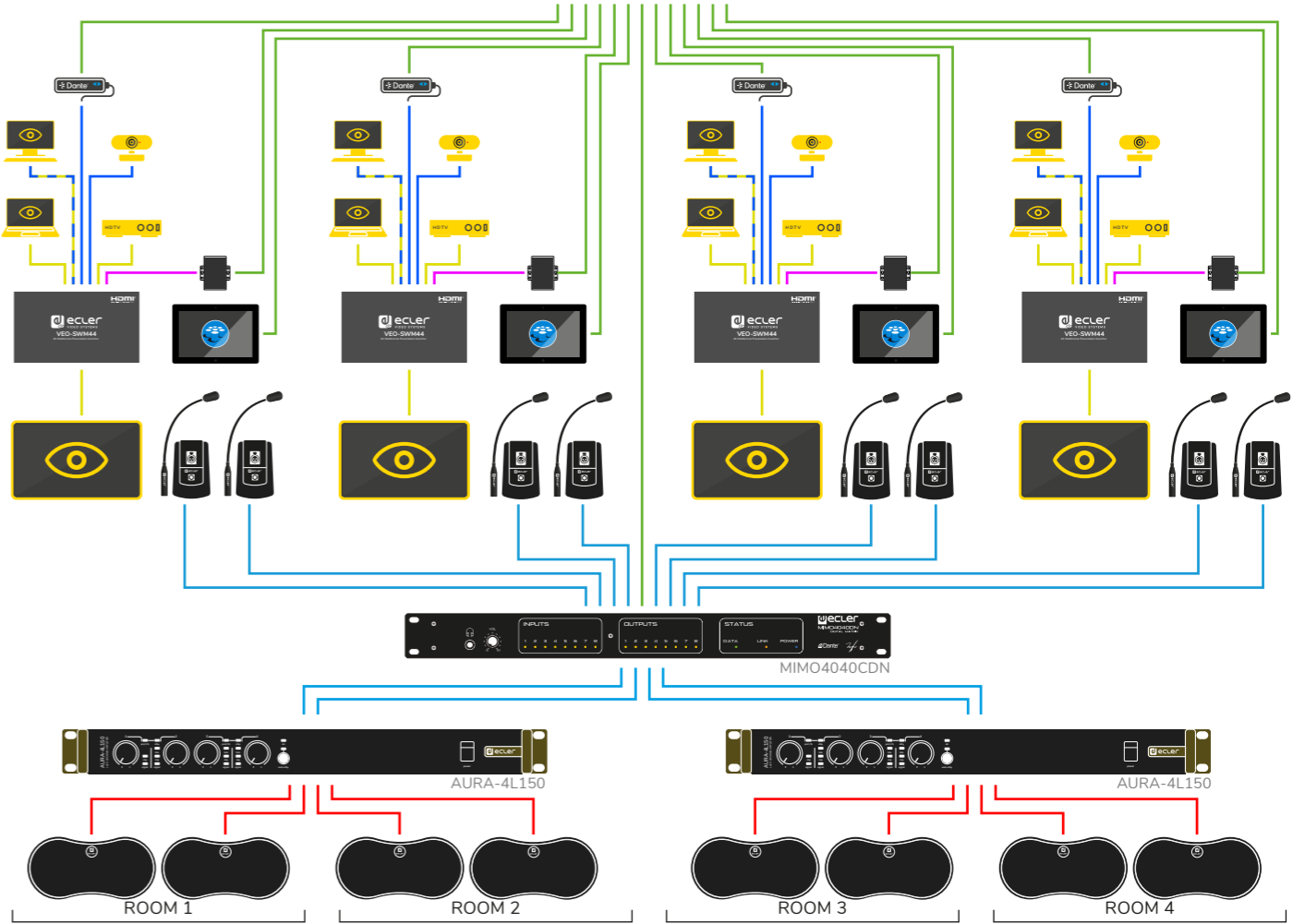

- RS-232 CABLE
- USB 3.0 Type A
- HDMI
- USB 3.0 Type B
- LOUDSPEAKER CABLE
- USB 3.0 Type C
- UNBAL. AUDIO CABLE
- UTP
- BAL. AUDIO CABLE
- UTP (Dante network)





Toyota and Lexus Garages (Saudi Arabia)



Hotel Vibre (Romania)



IM Clinic, Sant Cugat (Spain)

# CORPORATE CONFERENCE ROOM

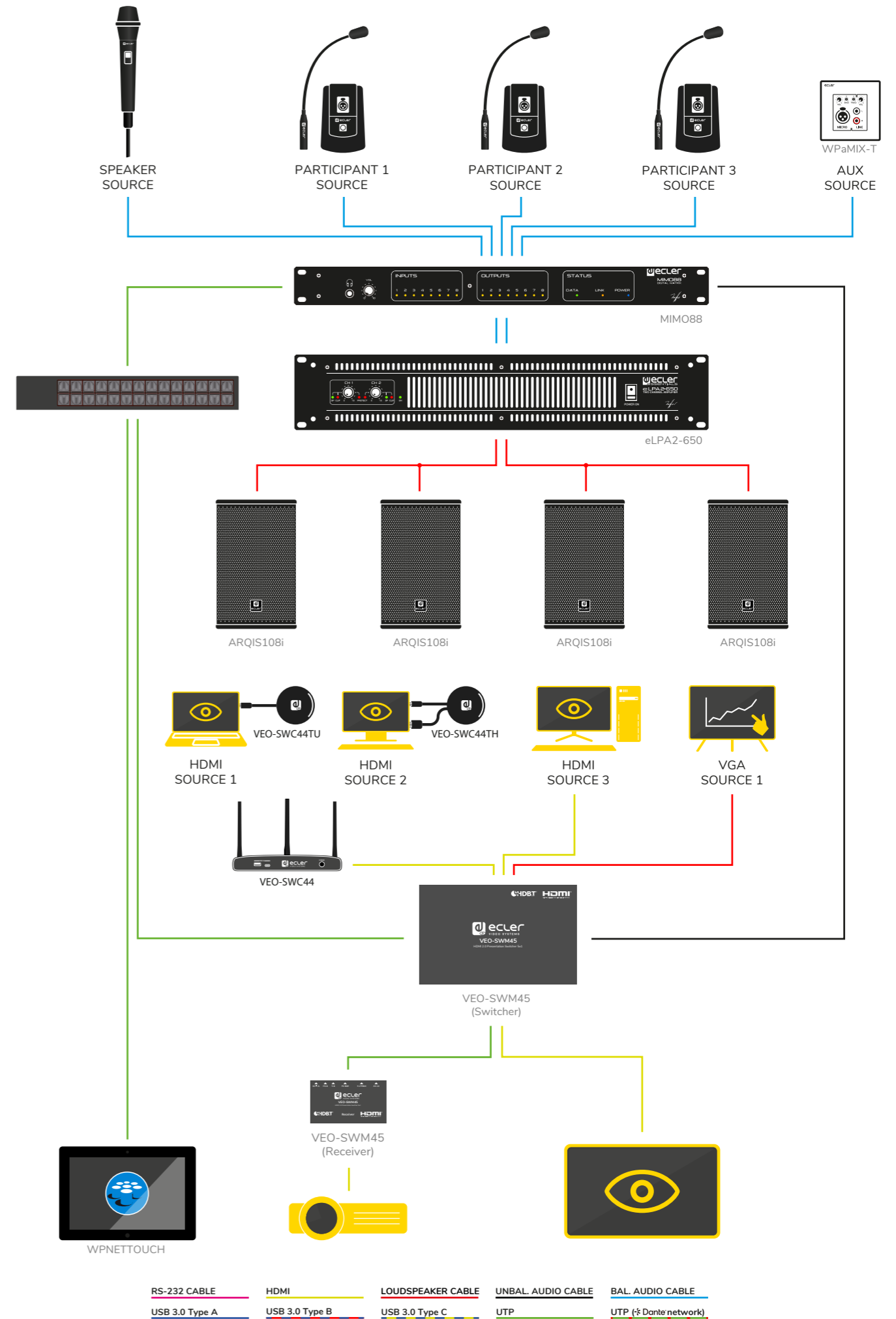





# HOSPITALITY

MULTIZONE HOTEL

# Hospitality

HOTELS / CAFÉS / RESTAURANTS / CAMPSITES

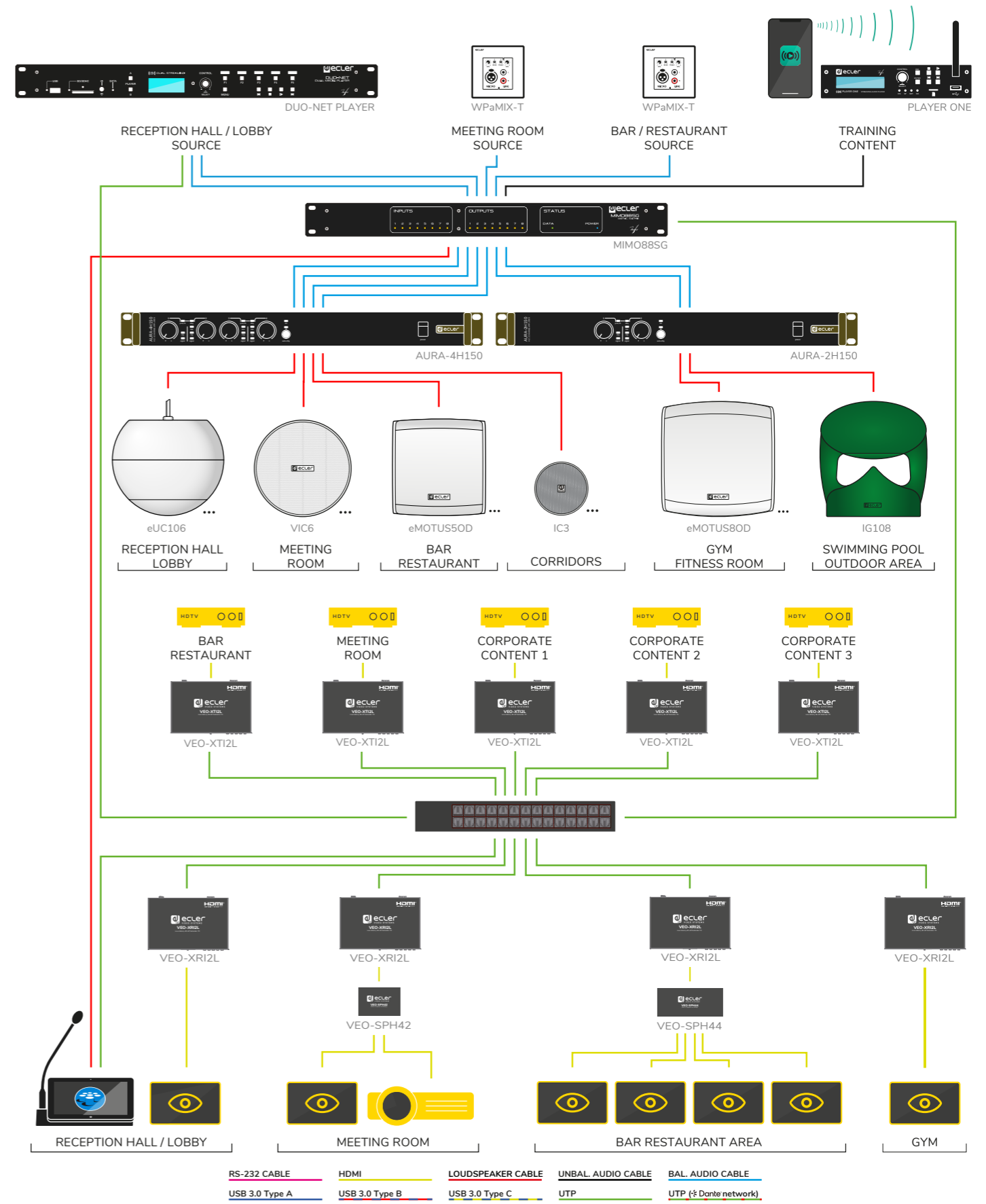





Hotel Vibre (Romania)

# HOSPITALITY

5 ZONE RESTAURANT



Six Senses, Instambul (Turkey)



Grande Hotel Thermas (Portugal)

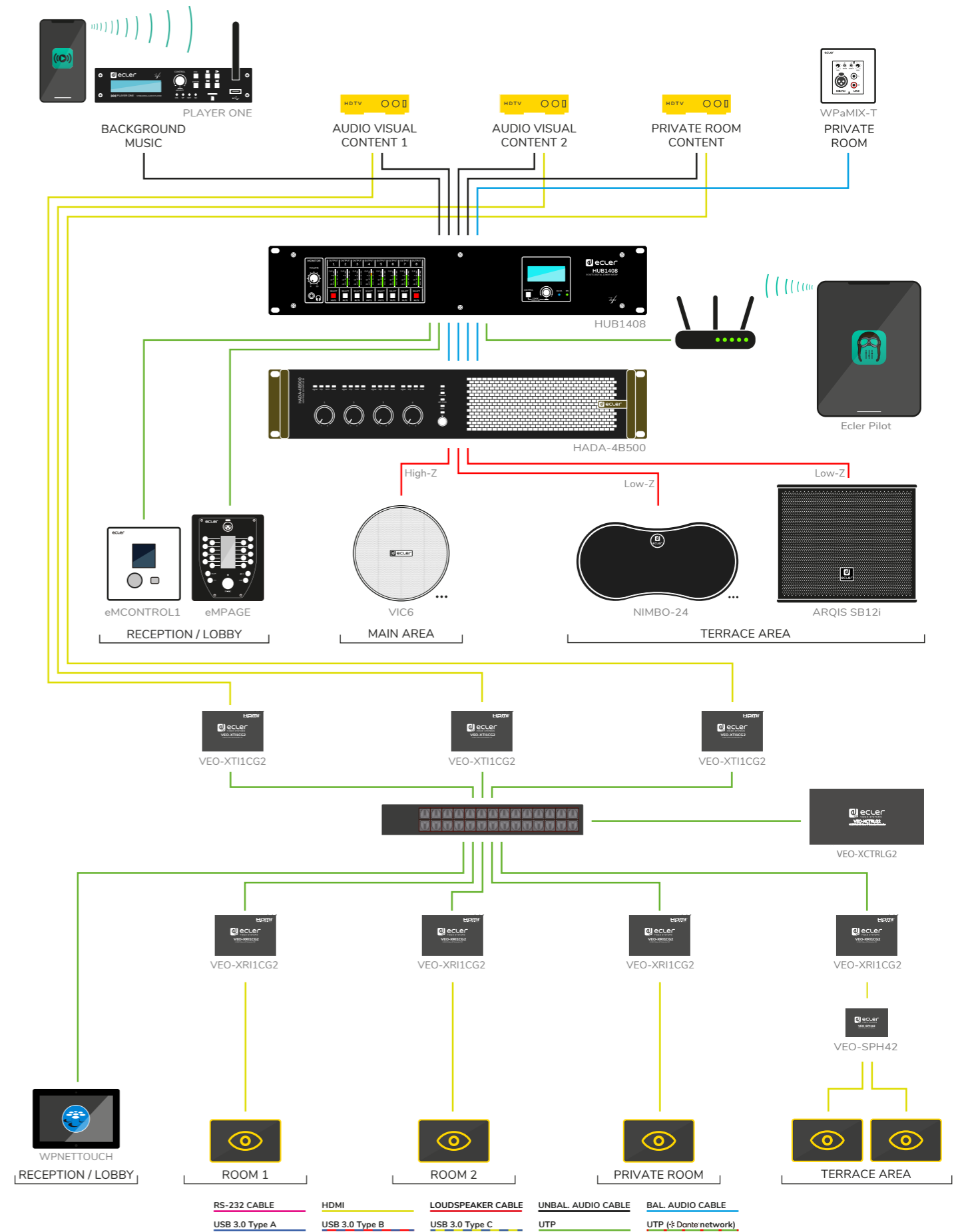





# HOSPITALITY

SPORTS BAR

Ristorante Sacco, Milano (Italy)



Harrys Bar (Singapore)

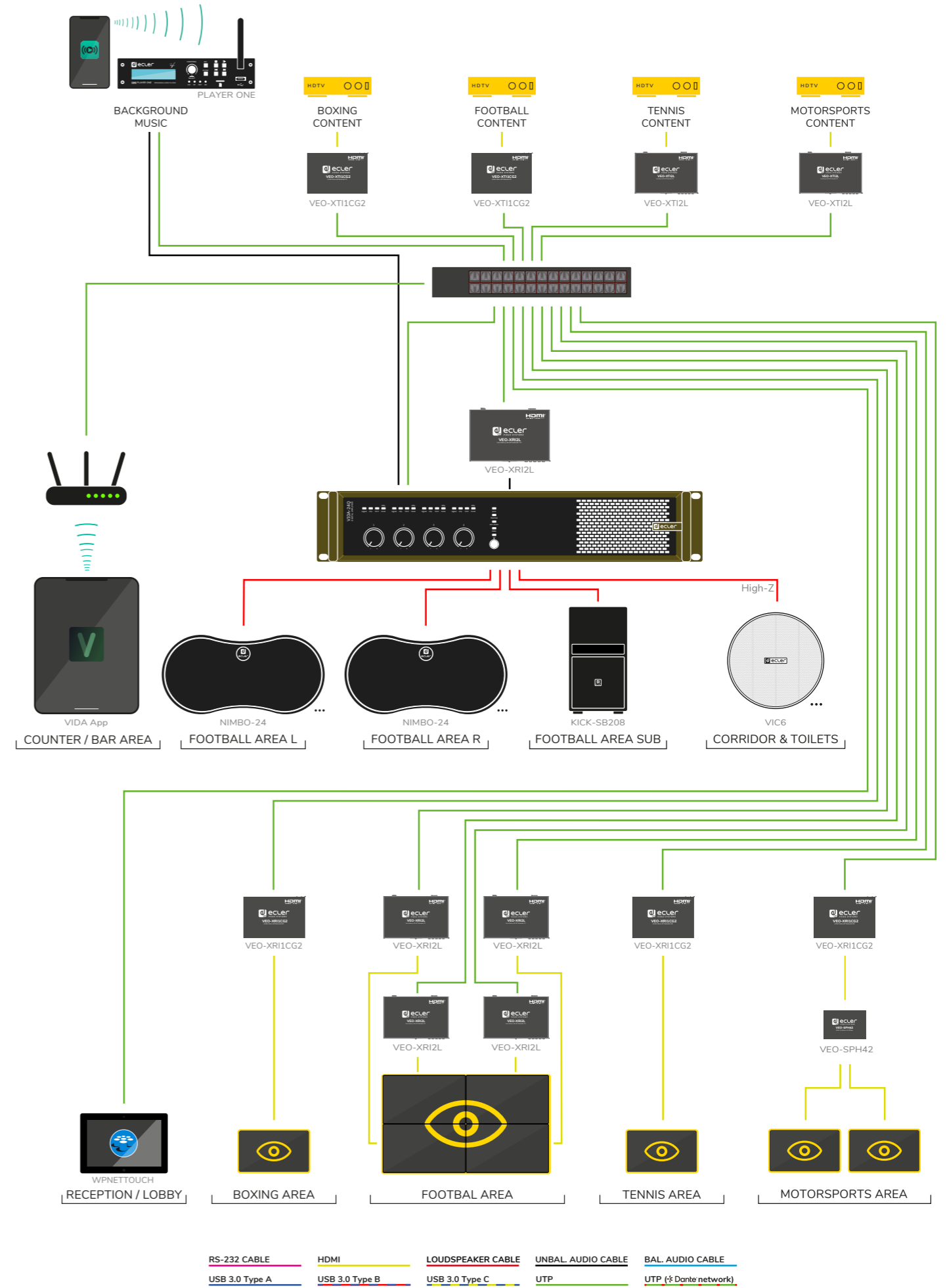





Valhalla Beach Club (Spain)

# HOSPITALITY

BEACH CLUB

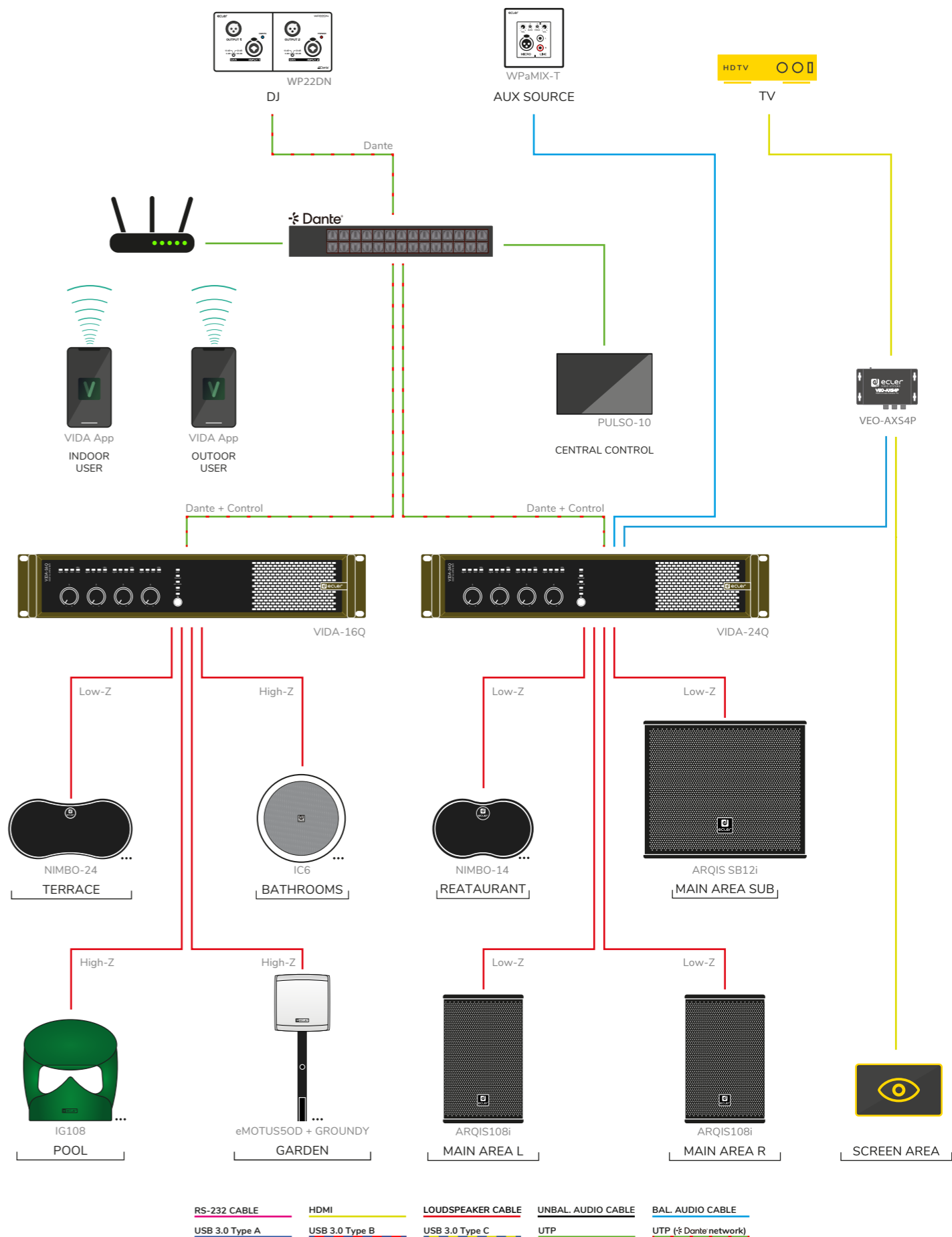

Mangia's Bruccoli, Sicily (Italy)





# EDUCATION

EDUCATION CENTER

# Education

SCHOOLS / CLASSROOMS / UNIVERSITIES / INSTITUTES

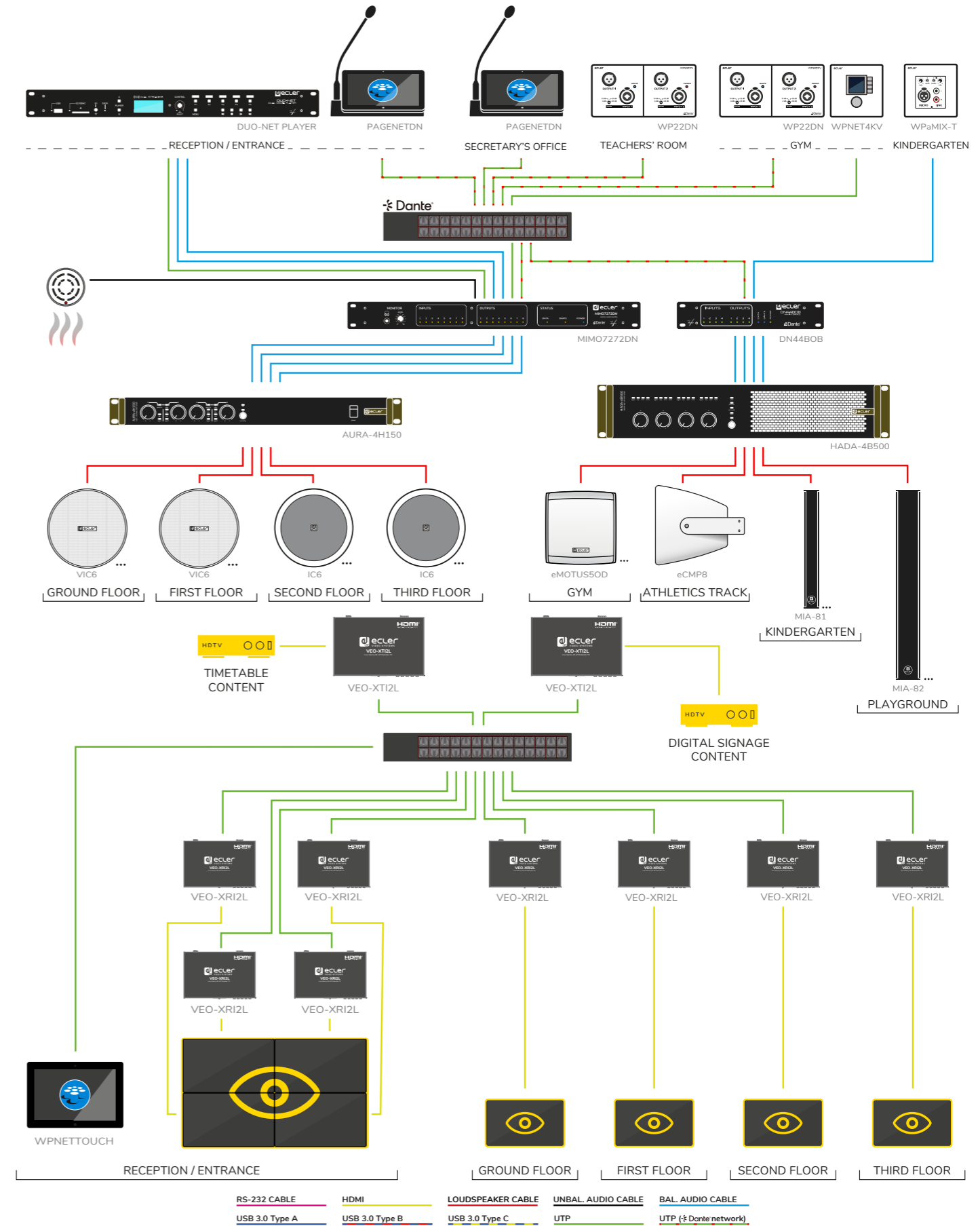



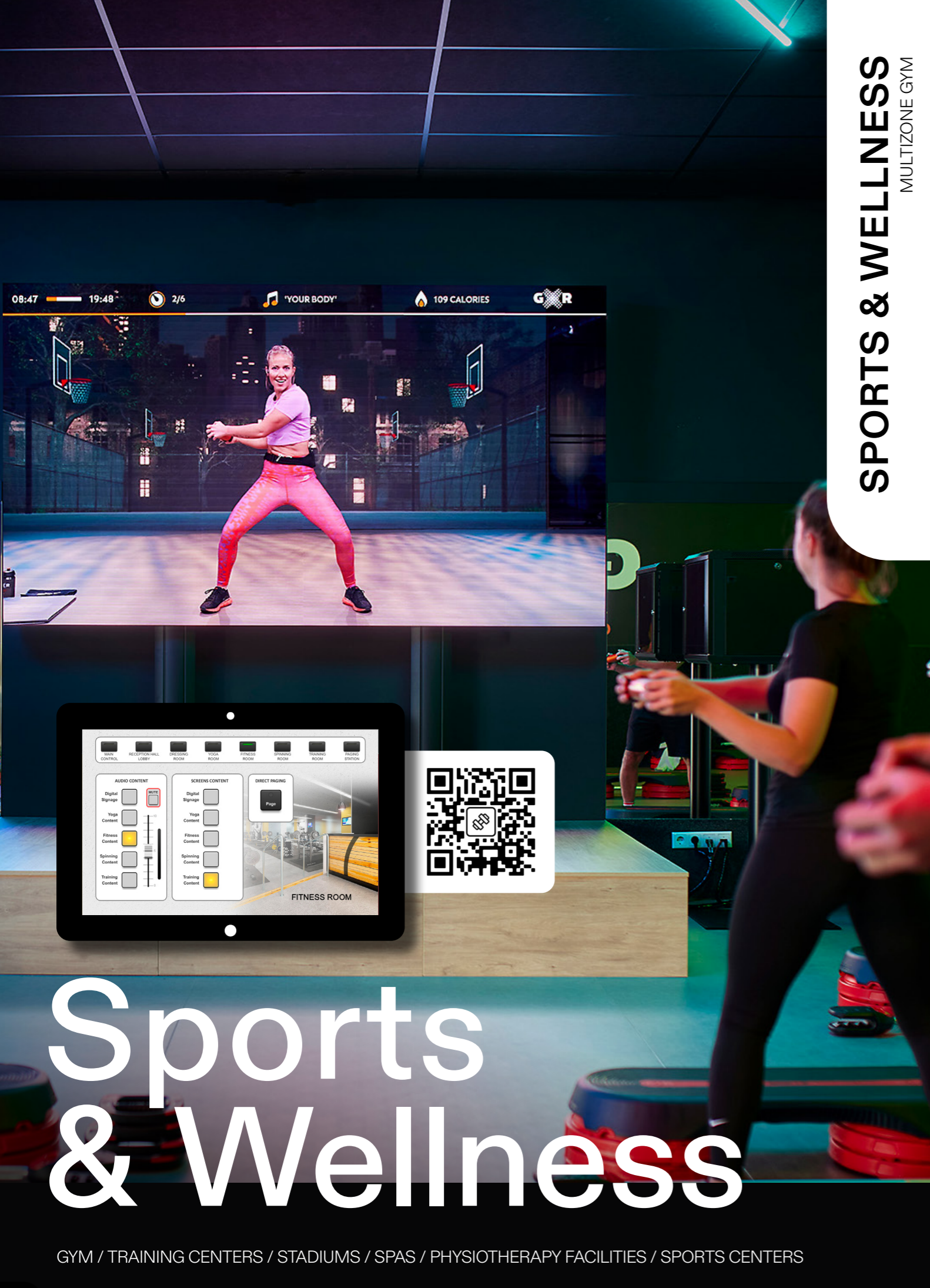

# SPORTS & WELLNESS

MULTIZONE GYM

# Sports & Wellness

GYM / TRAINING CENTERS / STADIUMS / SPAS / PHYSIOTHERAPY FACILITIES / SPORTS CENTERS

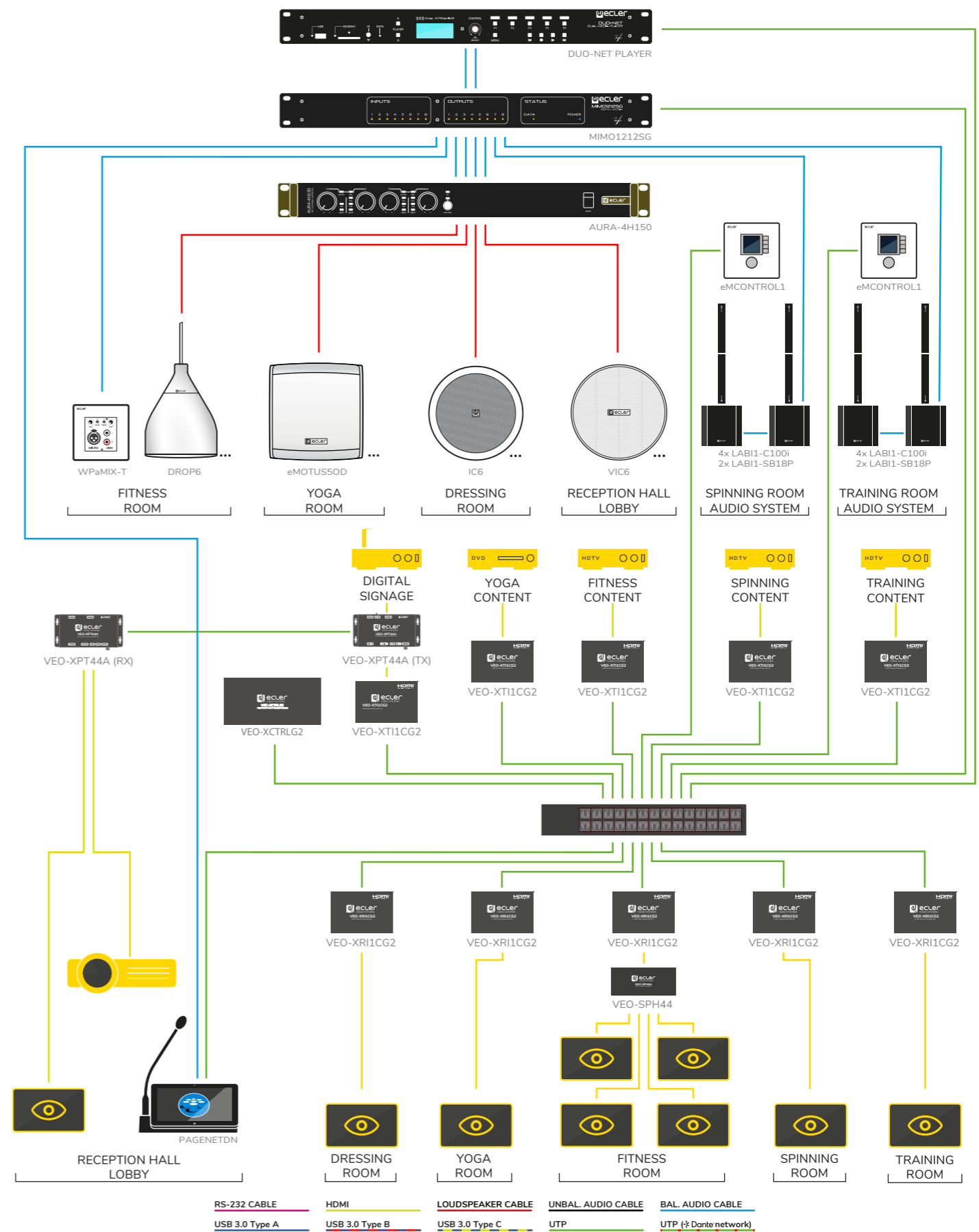





# House of Worship

CHURCHES / MOSQUES / SINAGOGUES / HINDU TEMPLES



# Leisure

MUSEUMS / PUBS AND BARS / PARKS / OPEN AREAS



# Products Audio





# CORE

Wireless Transmitter

WiSpeak  
WIRELESS PRO AUDIO

Bluetooth



CORE

Ecler **WiSpeak CORE** is the transmitter device that communicates with all the receiver devices to create a WiSpeak wireless network, and takes the role of the Master Unit. Together with TUBE, CUBE and GLOBE, provides a simple and fast wireless audio installation with up to 500m<sup>2</sup> coverage.

## KEY FEATURES

- 3 audio inputs available:
  - Analogue stereo, unbalanced. 2 x RCA connectors
  - Analogue stereo, balanced. 2 x Euroblock 3p connectors
  - Bluetooth®, class 1 (up to 25 meters range, maximum)
  - 1x WiSpeak wireless audio signal transmitted (a mono conversion of the selected input)
- 1x AUX OUT analogue signal available (a copy of the transmitted WiSpeak signal). It can be used for linking the unit to external audio devices, like amplifiers, mixers or subwoofer units
- Maximum number of receivers under control per transmitter device = 24 units. The network can be extended by linking a new transmitter to an existing receiver
- Front panel controls for source (input) selection and general (Master) volume control
- 12 meters maximum range, open space, for the WiSpeak wireless network (from the transmitter to each receiver, star topology)
- Front panel PAIR key: it allows pairing the receivers to the transmitter quickly and easily, for a basic set up of the WiSpeak system.
- External, universal Power Supply (100-240VAC 50-60Hz)
- Compatible with WiSpeak grip app for set up and control functions (available for Android and iOS), using Bluetooth® connection

	CORE
Inputs	IN1: Balanced, Stereo, Euroblock   IN2: Unbalanced, Stereo, RCA   BT: Bluetooth wireless
Outputs	RF Channels 1 & 2 AUX OUT: Analog, Mono, Balanced, Euroblock
Audio Channels	WiSpeak CH 1&2
Frequency Band	U-NII 5.1 – 5.8GHz (supported worldwide)
Dimensions (WxHxD)	225x120x40mm / 8.9"x4.7"x1.6"
Weight	0.8kg / 1.76 lb

## APPLICATIONS



WiSpeak (Wireless Pro Audio)



# TUBE / CUBE

Wireless Receivers

WiSpeak  
WIRELESS PRO AUDIO



TUBE

TUBE real panel

CUBE

CUBE real panel

## ACCESSORIES

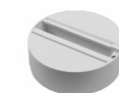

TUBESMA

Ecler **WiSpeak TUBE/CUBE** is a self-powered 3"/5" loudspeaker with wireless audio reception and control capabilities under the control of the Master unit.

**TUBESMA** is a surface mount adapter to allow installing a TUBE unit in locations where there is no available lighting rail.

## KEY FEATURES

- Lighting rail mount compatible (Compatible light rails: 4 wire 3 circuit track system such as Global Track Pro, Eutrac or compatibles)
- Universal, internal power supply, taking mains AC from the lighting rail bracket (100-240VAC 50-60Hz)
- External AC wire included (CUBE)
- 1x WiSpeak wireless audio signal received, from the transmitter it is paired to
- 1x AUX OUT analogue signal available (a copy of the received WiSpeak signal). It can be used for linking the unit to external audio devices, like amplifiers, mixers or subwoofer units
- Back panel UNPAIR control and LED indicators
- 12 meters maximum range, open space, for the WiSpeak wireless network (from the transmitter to each receiver)
- Available in white (RAL 9003) and black colour (RAL 9005)

	TUBE	CUBE
Inputs	RF Wireless Audio	RF Wireless Audio
Driver	3" driver	5" woofer + 1" tweeter
Audio Channels	WiSpeak CH 1&2	WiSpeak CH 1&2
Frequency Band	U-NII 5.1 – 5.8GHz (supported worldwide)	U-NII 5.1 – 5.8GHz (supported worldwide)
Dimensions (WxHxD)	96mmx110mm / ø3.8"x4.3" (without arm)	173x180x185mm / 6.81"x 7.08"x7.28"
Weight	0.8kg / 1.76 lb	2,4 kg / 5.29 lb

## APPLICATIONS



WiSpeak (Wireless Pro Audio)





# GLOBE

Wireless Receivers

**WiSpeak**  
WIRELESS PRO AUDIO



GLOBE (Rail-mount version)

**WiSpeak GLOBE** is a 2-way self-powered sphere loudspeaker with wireless audio reception and control capabilities under the control of the Master unit. It includes a 5" woofer and a 1" silk dome tweeter. 360° horizontal dispersion. Available in two versions - with light-rail compatible installation system (RM) and pendant installation system (PD).

## KEY FEATURES

- 32W RMS power rating
- Dispersion 360° x 160° (HxV)
- Glass fibre reinforced ABS
- RM version lighting rail mount compatible (Compatible light rails: 4 wire 3 circuit track system such as Global Track Pro, Eutrac or compatibles)
- PD version with 2 x 5m steel cords for pendant installation
- RM version with universal, internal power supply, taking mains AC from the lighting rail bracket (100-240VAC 50-60Hz)
- PD version with Euroblock power supply connection
- 1x WiSpeak wireless audio signal received, from the transmitter it is paired to
- Front panel UNPAIR control and LED indicators
- 12 meters maximum range, open space, for the WiSpeak wireless network (from the transmitter to each receiver)
- Available in white (RAL 9003) and black colour (RAL 9005)

	GLOBE
Inputs	RF Wireless Audio
Driver	5" woofer + 1" silk dome tweeter
Audio Channels	1 mono audio channel
Frequency Band	U-NII 5.1 – 5.8GHz (supported worldwide)
Dimensions (WxHxD)	Ø287mm x 331mm(H) / Ø11.3 in. x 13 in. (H)
Weight	2.2 Kg / 4.85 lbs

## APPLICATIONS



WiSpeak (Wireless Pro Audio)



# WiSpeak grip

Android / iOS Application

**WiSpeak**  
WIRELESS PRO AUDIO

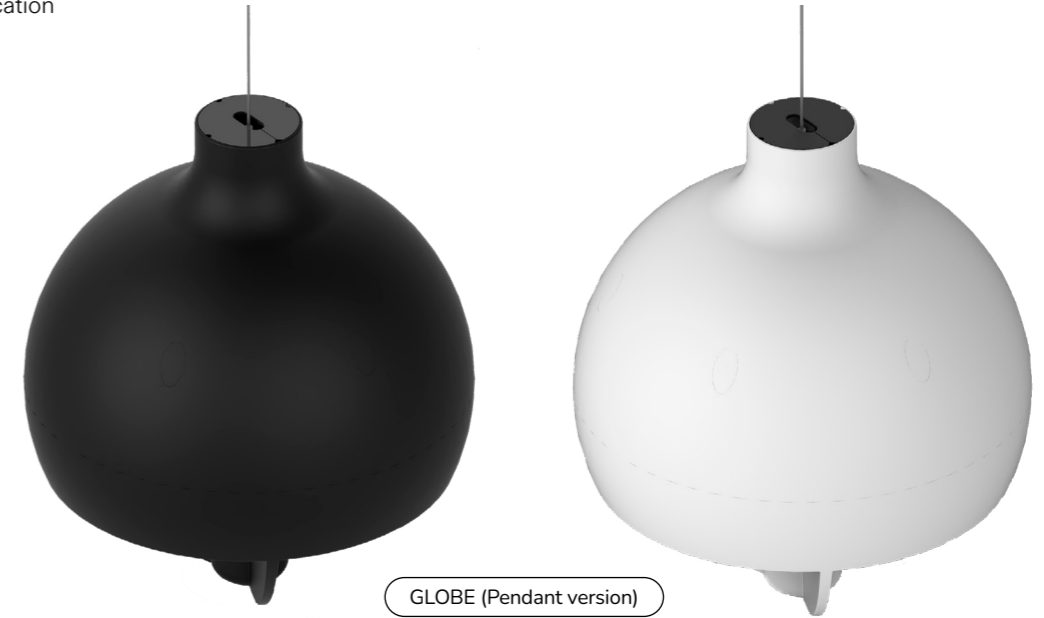

GLOBE (Pendant version)

WiSpeak grip app

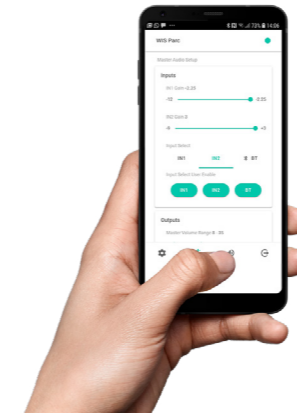

CORE



**WiSpeak grip** is an Android/iOS app for the setup and control of a WiSpeak Wireless Audio System. It is compatible with Android 5.0 or higher / iOS11 or higher. A WiSpeak system is made up of one transmitter device (CORE model) and from 1 up to a maximum of 24 receiver units (TUBE, CUBE or GLOBE models).

## KEY FEATURES

- WiSpeak grip admits two different user profiles:**
- Administrator: allows to connect via bluetooth to the transmitter devices in the installation and, from them, automatically discover and pair the available receiver devices (loudspeakers), thus creating a WiSpeak wireless audio network. It allows as well to monitor each and every transmitter and receiver device in the network, to adjust

every connection and audio parameter (emission channels, HPF and LPF filter, EQ, Master and individual volumes, etc.) and to define the privileges that the end user will have for the daily use management of the system

- End user: it shows a very simple control interface of the system (just one screen) including volume control and source selection, both limited to the options previously defined by the Admin user as available for the End user

## APPLICATIONS



WiSpeak (Wireless Pro Audio)





# eMHH1/eMCN2 eMBASE/eMICFIT2

Microphones

Sound Sources



eMHH1

eMBASE

eMCN2

eMICFIT2

## ACCESSORIES

### eMHH1:



MBSTAND



MDSTAND

**eMHH1** is an affordable handheld dynamic microphone, with a robust design that makes it ideal for voice applications. It comes with a microphone stand adapter and 6 metres XLR-Jack cable.

**eMCN2** is a condenser gooseneck microphone, with a perfect profile for message, speech and conferencing applications. Total length = 55 cm. It includes anti-pop wind-screen cover.

**eMBASE** is a desktop connection base for the eMCN1 and eMCN2 microphones, as well as for other microphones with standard XLR connector. It includes ON / OFF switch that enables / disables the microphone signal.

**eMICFIT2** is a robust headset condenser microphone, including a water and sweat resistant treatment, ideal for sport and fitness applications. It performs an easy adjustment of the gooseneck and a discrete, light and comfortable design in combination with a robust and solid body. It features a mini-XLR 4-pin connector, compatible with the eMWE UHF wireless belt-pack unit. It includes anti-pop wind-screen cover and rigid case.

## APPLICATIONS



# DUO-NET PLAYER

Dual Audio Player



Sound Sources



DUO-NET PLAYER Controller

DUO-NET PLAYER

## ACCESSORIES



WPNETTOUCH

**DUO-NET PLAYER** is a double audio sound source that features full EclerNet compatibility.

## KEY FEATURES

- 2 independent media players, each one linked to a dedicated stereo output
- Compatible with mp3, ogg, AAC, WAV and FLAC audio formats
- SD and USB slots for local storage media contents
- Ethernet interface (RJ45 connector) for EclerNet and TP-NET control, Internet streaming reception and networked media playback
- Fully programmable and controllable via EclerNet software
- UCP (User Control Panels) remote control system, compatible with WPNETTOUCH and third-party client devices (iOS®, Windows® and Android®)
- 4 GPI ports (General Purpose Inputs) to trigger events
- Integrated RTC (Real-Time Clock) and NTP (Network Time Protocol) synchronization, for scheduled events triggering
- IR remote control for basic end-user control
- Priority media (emergency, advertising, etc.) over program audio

	DUO-NET PLAYER
Audio outputs	2 x stereo balanced, LINE level, Euroblock type
Communication Interfaces	1 x Ethernet (RJ45), 1 x RS-232 (DB9), 4 x GPI (Euroblock)
Local media	USB, SD/SDHC
Remote control	Included IR remote control
Dimensions (WxHxD)	482,6x44(1 RU)x120mm / 19"x1.73"x4.72"
Weight	1,8 kg / 3.97 lb

## APPLICATIONS





# eSAS-BT

Audio Player BT

Sound Sources



eSAS-BT



eSAS-BT Controller

eSAS-BT is a stereo audio source including FM tuner, USB slot, SD slot and BT connection.

## KEY FEATURES

- Audio player with BT
- USB, SD, FM tuner and BT connection
- 2xRCA unbalanced output (stereo)
- 2xXLR balanced output (stereo)
- Accessories included

	eSAS-BT
Audio outputs	1 x stereo unbal. + 1 x stereo bal
Audio inputs	-
Local media	USB, SD, FM tuner, BT connection
Accessories included	IR remote control + FM antenna + 2x RCA cables + rack-mount bracket
Dimensions (WxHxD)	435x44(1RU)x132mm / 17.13"x1.73"x5.20"
Weight	1,4 kg / 3.09 lb

## APPLICATIONS



ecler

# PLAYER ONE

Local SD/USB and Streaming / Airplay & DLNA player  
Control via RePLAYER mobile app  
Ecler Gallery remote management  
Calendar events trigger  
Cloud Disk Sync





# PLAYER ONE / ZERO

Streaming and Local Media Audio Player



PLAYER ONE

PLAYER ZERO

## ACCESSORIES

### PLAYER ONE:



1UHRMKIT

### PLAYER ZERO:



VEO-RACK19

**PLAYER ONE / PLAYER ZERO** is a compact audio player with a stereo output that can play music contents from local storage media (USB/MicroSD card), Internet streams or digital sharing streams (DLNA and Airplay compatible).

### KEY FEATURES

- Single-deck audio player
- Stereo output, RCA connectors and mini-jack
- Internet streaming receiver
- Digital sharing streams receiver (DLNA and Airplay)
- Local media player (from USB and MicroSD card slots)
- Front panel LCD display and local controls (PLAYER ONE)
- Programmable and controllable via front panel, embedded web app and Ecler Gallery
- Calendar events trigger, synchronization of contents hosted in the cloud (Cloud Disk Sync) and execution of "scripts" (files of instructions written by the user, Lua language – [www.lua.org](http://www.lua.org))
- Compatible with the JSON protocol

	PLAYER ONE	PLAYER ZERO
Audio outputs	1 x stereo unbalanced, LINE level, RCA type + minijack	2 x stereo unbalanced, LINE level, RCA type + minijack
Communication Interfaces	1 x Ethernet (RJ45), 1 x WiFi, 2 x GPI (0-10 VDC)	2 x Ethernet (RJ45), 1 x WiFi, 2 x GPI (0-10 VDC)
Local media	USB, SD/MicroSDHC	USB, MicroSD/SDHC
Others	RTC included, 120 hours aprox.	RTC included, 120 hours aprox.
Dimensions (WxHxD)	198.5x44x132 mm / 7.81"x1.73"x5.19"	126.5x44x132 mm / 4.98"x1.73"x5.19"
Weight	0.8 Kg / 1.76 lb	0.6 Kg / 1.32 lb

### APPLICATIONS



Sound Sources



# Ecler GALLERY / RePLAYER

Remote Management Platform for Ecler Players / Remote Control Application

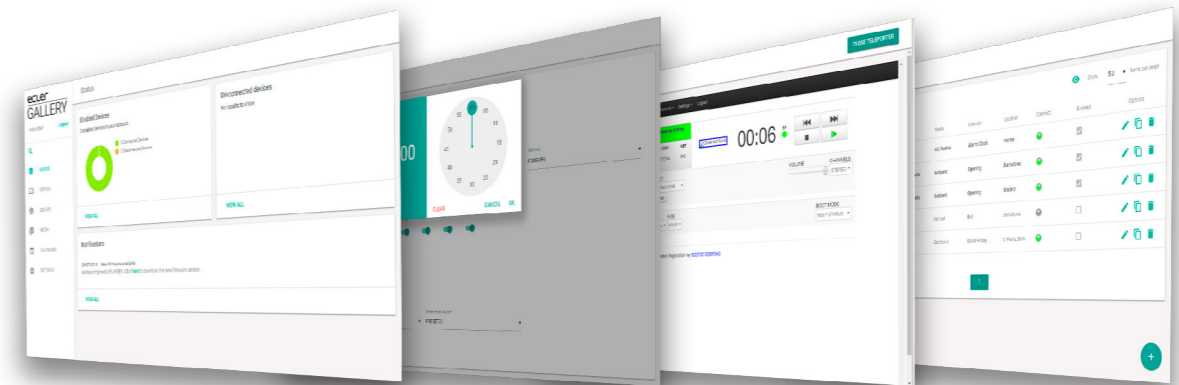

Ecler GALLERY

**Ecler GALLERY** features an online platform for Ecler audio player management. Supervise your player's connectivity status, make changes in the reproduction lists and calendars, set up basic or advance configurations, group your devices and much more. Everything could be done remotely. Sign up for Ecler Gallery account at [www.eclergallery.com](http://www.eclergallery.com) and discover all its possibilities. Compatible with ePLAYER1, PLAYER ONE and PLAYER ZERO.

## RePLAYER

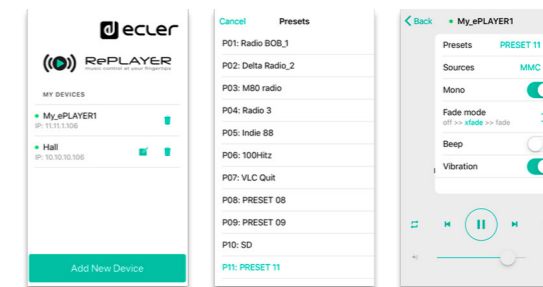
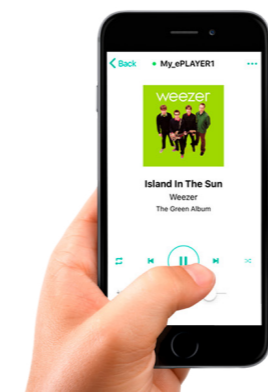

**RePLAYER** is an Android/iOS application for remote controlling basic user functions of Ecler ePLAYER1, PLAYER ONE and PLAYER ZERO streaming media players. These basic functions include preset and audio source selection, volume control, playback control (PLAY/PAUSE, NEXT, PREV) and other settings such as repeat mode, mono/stereo or fade mode. All this in a simple to use application, with an intuitive design. Music control at your fingertips.

### APPLICATIONS



Sound Sources





# eSAM Series

Installation Analogue Mixers



## ACCESSORIES



MPAGE1r



WPaMIX-T

## KEY FEATURES

### eSAM Series:

- 19" installation mixer
- MIC/LINE ST inputs & LINE ST inputs (eSAM603: additional MIC input)
- eSAM402 & eSAM702: 1 main mix output and one AUX/REC additional output.
- eSAM603: 1 ST/2 MONO main mix output and one MONO output. One AUX/REC additional output
- eSAM402 & eSAM702: 3 band tone control section.
- eSAM603: 2 x 3-band tone control section (A/B and C)
- Talkover (priority) function assignable from each MIC/LINE input over the mix
- Micro sensitivity level can be adjusted on the back panel
- +18V Phantom Power available for all MIC inputs
- MUTE port for external dry contact triggering

	eSAM402	eSAM702	eSAM603
Inputs	3 MIC/ST LINE + 1 ST LINE	6 MIC/ST LINE + 1 ST LINE	4 MIC/ST LINE + 1 MIC + 1 ST LINE
Outputs	1 MAIN ST + 1 AUX/REC	1 MAIN ST + 1 AUX/REC	1 MAIN ST/ 2 MONO (selectable) + 1 MONO + AUX/REC
Tone control	Bass, mid & treble (mix)	Bass, mid & treble (mix)	Bass, mid & treble (per mix)
Remote control	MUTE contact	MUTE contact	MUTE contact
Dimensions (WxHxD)	482,6x44 (1RU)x120mm / 19"x1.73"x4.72"	482,6x44 (1RU)x120mm / 19"x1.73"x4.72"	482,6x44(1RU)x195mm / 19"x1.73"x 7.67"
Weight	1,7 kg / 3.75 lb	1,8 kg / 3.97 lb	2,1 kg / 4.63 lb

## APPLICATIONS



Analogue Preamplifiers & Mixers



# SAM Series

Installation Analogue Mixers



## ACCESSORIES



MPAGE1r



WPaMIX-T

## KEY FEATURES

### SAM Series:

- 4 (SAM412T) / 6 (SAM612T) input channels, 2 main outputs 19" installation mixers
- Micro sensitivity level can be adjusted on the back panel
- Direct micro input on front panel, channel 1
- Includes a talkover assigned to MIC/LINE 1
- Three-band tone controls for each channel, accessible with a screwdriver
- Vu-meter for the mix signal (SAM412T)
- 1 ST main output
- AUX/REC output
- Direct access to the mixing bus
- Remote MUTE control
- Mono/stereo switch

	SAM412T	SAM612T
Inputs	4 MIC/ST LINE + 1 ST MIX	6 MIC/ST LINE + 1 ST MIX
Outputs	2 MAIN ST + 1 REC	1 MAIN ST + 1 AUX/REC
Tone control	Bass, mid & treble (per input)	Bass, mid & treble (per input)
Remote control	MUTE contact	MUTE contact
Dimensions (WxHxD)	482,6x44(1RU)x195mm / 19"x1.73"x 7.67"	482,6x44(1RU)x195mm / 19"x1.73"x 7.67"
Weight	2,4 kg / 5.29 lb	2,0 kg / 4.41 lb

## APPLICATIONS



Analogue Preamplifiers & Mixers





# eCOMPACT4BT

Installation Analogue Mixer



eCOMPACT4BT

## ACCESSORIES



WPaMIX-T

## KEY FEATURES

- Analogue mixer with 4 channels, 19" rack installation or desktop
- 4 mic inputs, one of them with Talkover function. 48V Phantom power
- Bluetooth® Class 1 wireless connection (up to 25m range in ideal conditions)
- Selectable high-pass filter (fc = 100Hz)
- 3-band tone control (treble, mid and bass)
- Send to alternative output (ALT OUT) per channel
- USB port for charging mobile devices
- Rack mount accessory included

	eCOMPACT4BT
Channels	4 with independent gain & 45mm fader
Inputs	6 ST LINE + 1 ST mini-Jack + 4 MIC + Bluetooth® connection
Outputs	2 MAIN ST + 2 ALT ST + 1 SUB + 1 PHONES
Tone control	Bass, mid & treble (per channel)
Dimensions (WxHxD)	440x132(3RU)x125mm / 17.32"x5.19"x4.92"
Weight	3,0 kg / 6.61 lb

## APPLICATIONS



Analogue Preamplifiers & Mixers



# ECLERNET 10 YEARS OF AV EXPERIENCES

A decade of innovating for **the best pro A/V system building platform.**



### COMPATIBLE

Identifiable and configurable device in an EclerNet project



### INTEGRABLE

Integrable and controllable device in an EclerNet project through IP or RS-232 commands with ETH232AD accessory

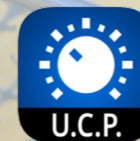

**BUILDING A DIGITAL AUDIO-VIDEO SYSTEM HAS NEVER BEEN SO EASY!**



CUSTOMIZED CONTROL PANELS WITH YOUR IMAGES / LOGOS



REMOTE CONTROL FROM YOUR MOBILE DEVICE



SET UP AN AUDIO, VIDEO AND CONTROL SYSTEM



SCHEDULE THE FUNCTIONING OF YOUR INSTALLATION THROUGH EVENTS AND PRESETS



A SOLID AND CONTINUOUSLY IMPROVING PLATFORM

## THIRD PARTY CONTROL DRIVERS





# MIMO7272DN

Dante™ Digital Matrix

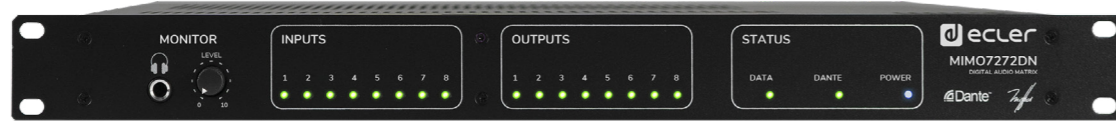

MIMO7272DN



## ACCESSORIES



WPNETTOUCH



PAGENETDN



WP22DN



WPNET4KV/8K



WPaMIX-T



WPa Series

**MIMO7272DN** is a digital matrix including a native (full DSP) matrix of 64x64 input and output audio channels total size. Incorporating audio over IP technology, MIMO7272DN allows digital audio transmission using a Local Ethernet network, suppressing cabling distance limitations. MIMO7272DN is also capable of executing EclerNet projects embedded into its processor and electronics engine, acting as a UCP (User Control Panels) server within an EclerNet devices network.

## KEY FEATURES

- 64 x 64 digital audio channels native matrix, with a total of 72x72 audio inputs / outputs support:
  - 8 MIC / LINE analog audio inputs
  - 8 LINE analog audio outputs
  - 64 Dante™/ AES67 input channels
  - 64 Dante™/ AES67 output channels
- 8 GPI ports
- 8 GPO ports
- 2 Dante™ interfaces (primary and secondary), available for configuration of redundant Dante™ networks
- 1 Ethernet programming and control interface (EclerNet, UCP, TP-NET and WPNET series control panels)
- 1 serial control port, RS-232 (TP-NET)
- Embedded project manager and server of the project's integrated UCP panels
- Connection of all peripherals directly via EtherNet network, and without local wiring (remote controls WPNET series, PAGENETDN paging station, WP22DN wall panel Dante™/ AES67 interface, etc.)
- Available only with Standard firmware version (no Conference version available)

	MIMO7272DN
Inputs	8 analog + 64 Dante (64 inputs native matrix)
Outputs	8 analog + 64 Dante (64 outputs native matrix)
Communication Interfaces	1 Ethernet + 1 RS232
Remote control	8 GPI + 8 GPO ports
Dimensions (WxHxD)	482,6x44(1RU)x266,5mm / 19"x1.73"x10.49"
Weight	3,25 kg / 7.16 lb

## APPLICATIONS



MIMO7272DN



EclerNet Manager

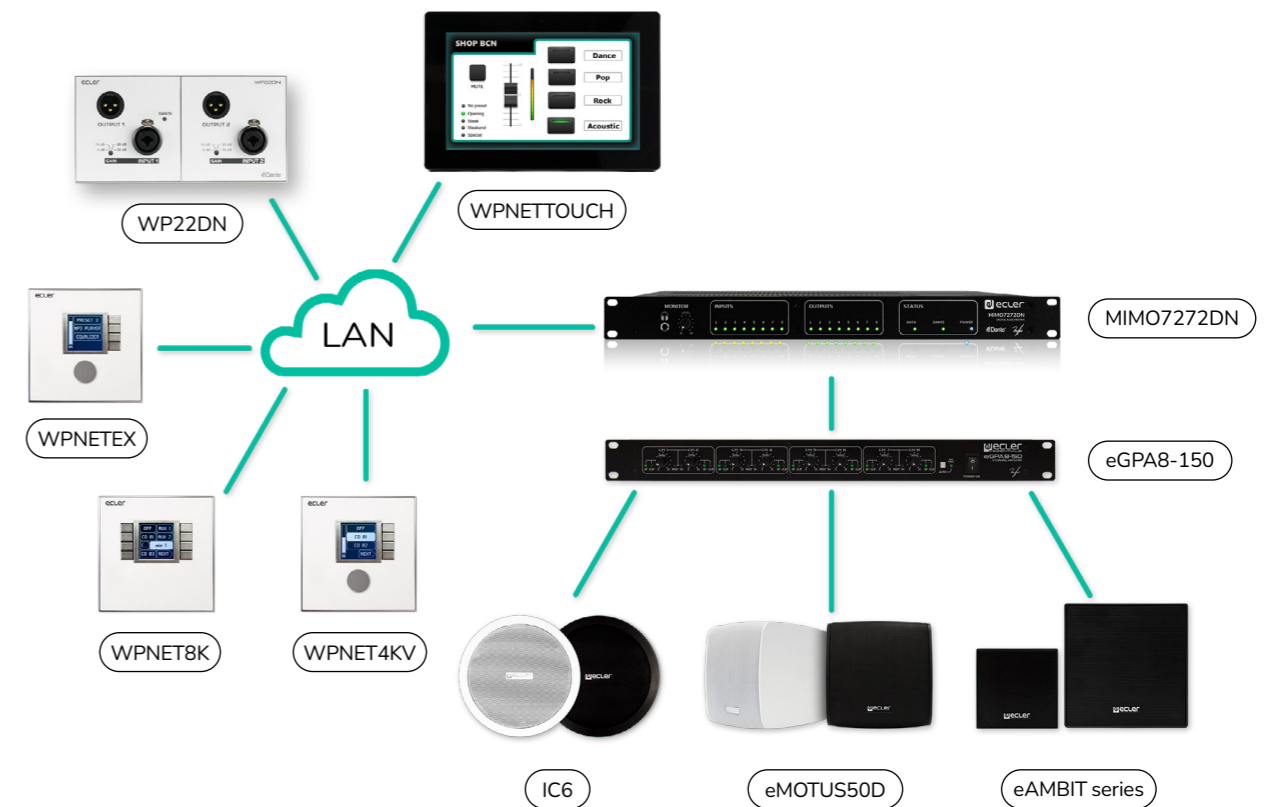



# MIMO4040CDN

Dante™ Digital Matrix



MIMO4040CDN

## ACCESSORIES



## WPNETTOUCH



## WP22DN



## WPNET4KV/8K



## WPaMIX-T



## WPa Series

MIMO4040CDN is a digital audio matrix including a native (full DSP) matrix of 40x40 input and output audio channels total size, specially designed for conference rooms. It includes functions such as AUTOMIXER or FEEDBACK KILLER by default, as well as up to 8 microphone channels with AEC (Acoustic Echo Canceling) processing activated by software licenses.

## KEY FEATURES

- 40 x 40 digital audio channels native matrix, with a total of 40x40 audio inputs / outputs support:
  - 8 MIC / LINE analog audio inputs
  - 8 LINE analog audio outputs
  - 32 Dante™/ AES67 input channels
  - 32 Dante™/ AES67 output channels
- 8 GPI ports
- 8 GPO ports
- 2 Dante™ interfaces (primary and secondary), available for configuration of redundant Dante™ networks
- 1 Ethernet programming and control interface (EclerNet, UCP, TP-NET and WPNET series control panels)
- 1 serial control port, RS-232 (TP-NET)
- Embedded project manager and server of the project's integrated UCP panels
- Connection of all peripherals directly via Ethernet network, and without local wiring (remote controls WPNET series, WP22DN wall panel Dante™/ AES67 interface, etc.)

	MIMO4040DN
Inputs	8 analog + 32 Dante
Outputs	8 analog + 32 Dante
Communication Interfaces	1 Ethernet + 1 RS232
Remote control	8 GPI + 8 GPO ports
Dimensions (WxHxD)	482,6x44(1RU)x266,5mm / 19"x1.73"x10.49"
Weight	3,25 kg / 7.16 lb

## APPLICATIONS

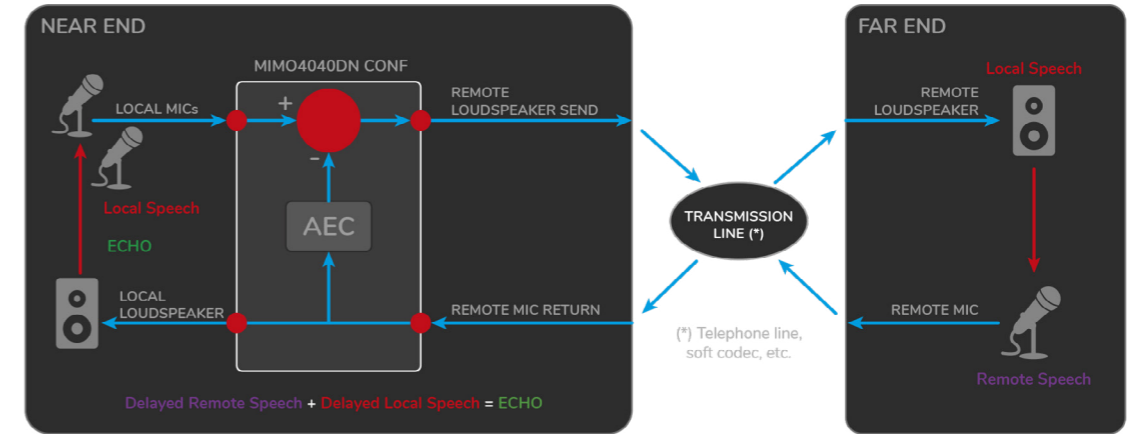

AEC conceptual scheme

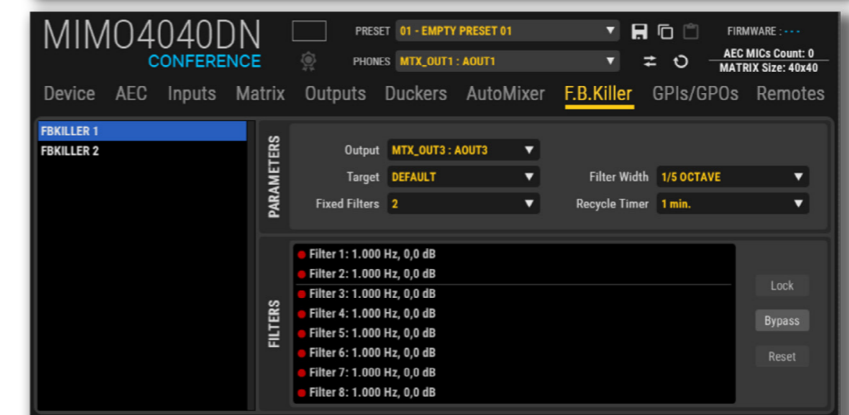
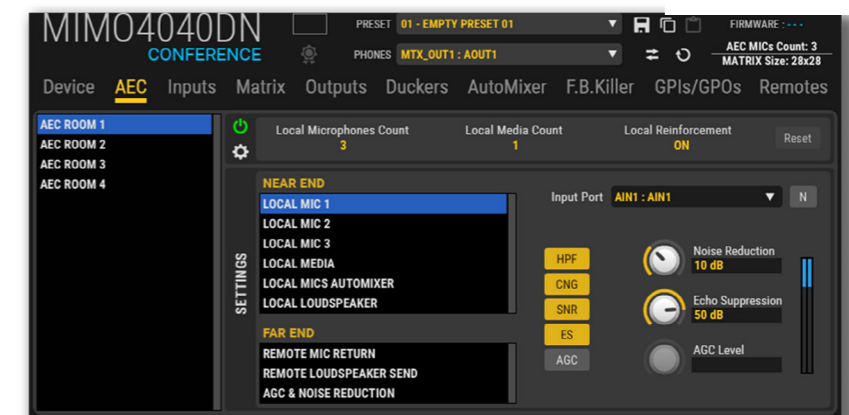

EclerNet Manager MIMO4040CDN Features





# MIMO88 / 88SG / 1212SG

Digital Matrixes



MIMO88



MIMO88SG



MIMO1212SG

## ACCESSORIES



## WPNETTOUCH



## eMPAGE



## PAGENETDN



## WPNET4KV/8K



## WPaMIX-T



## WPa Series

## KEY FEATURES

- Fully programmable and controllable via EclerNet software
- Linkable to a second unit to become a 16x16 matrix (MIMO88)
- MIMO88SG: 8x8 digital matrix (not expandable)
- MIMO1212SG: 12x12 digital matrix (not expandable)
- UCP (User Control Panels) remote control system, compatible with WPNETTOUCH and third-party devices, such as computers, tablets, smartphones, etc.
- TP-NET protocol compatible, for third-party control systems integration
- DSP processing: signal generator, delays, full parametric EQ filters at inputs and outputs, inputs noise gate, level, mute, phase, vu-meters, outputs compressor / limiter, ducking (priority & overriding), virtual and physical paging stations management, automatic mixer function, presets save & recovery, scheduled events triggering, etc.
- FREQUENCY SHIFTER function to avoid acoustic feedback (Larsen Effect), available for each INPUT channel

	MIMO88	MIMO88SG	MIMO1212SG
Inputs	8 MIC/LINE Bal. (Euroblock)	8 MIC/LINE Bal. (Euroblock)	12 MIC/LINE Bal. (Euroblock)
Outputs	8 Bal. (Euroblock) + 2 Monitor (Euroblock)	8 Bal. (Euroblock)	12 Bal. (Euroblock)
Communication Interfaces	1 Ethernet + 1 RS232	1 Ethernet + 1 RS232	1 Ethernet + 1 RS232
Remote control	8 GPI + 8 GPO + 2 Digital control bus	8 GPI + 1 Digital control bus	12 GPI + 1 Digital control bus
Dimensions (WxHxD)	482,6x44(1RU)x266,5mm / 19"x1.73"x10.5"	482,6x44(1RU)x266,5mm / 19"x1.73"x10.5"	482,6x44(1RU)x266,5mm / 19"x1.73"x10.5"
Weight	3,5 kg / 7.72 lb	3,5 kg / 7.72 lb	3,5 kg / 7.72 lb

## APPLICATIONS



Digital Matrixes & Processors



# MIMO CONFERENCE

Firmware MIMO

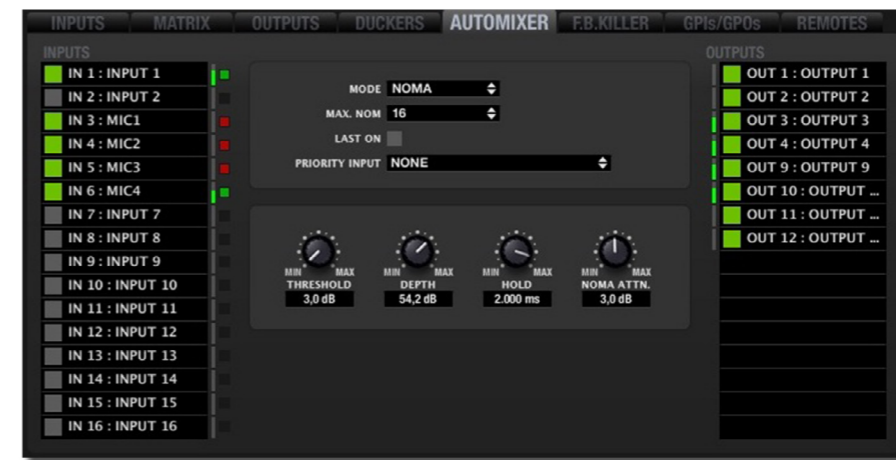
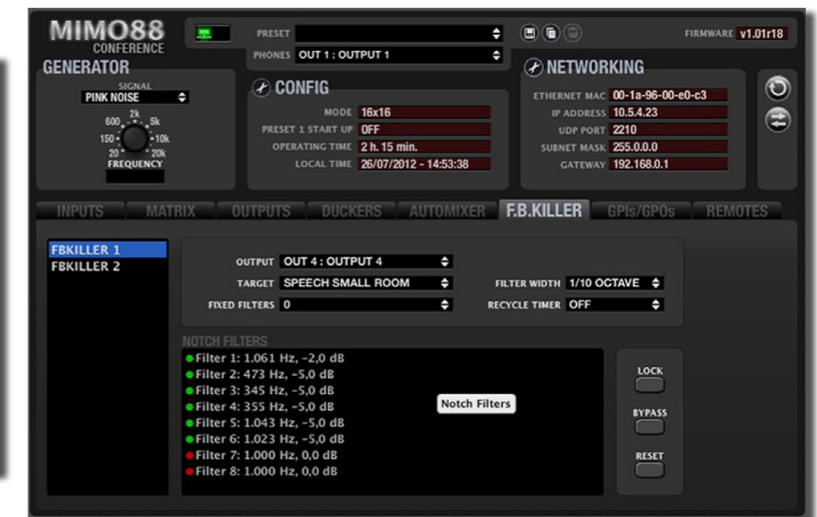

MIMO CONFERENCE

**MIMO CONFERENCE** has been especially designed for those applications that involve conferencing, microphone automatic mix processing and feedback loops (Larsen effect) cancellation. MIMO Conference shares the same hardware of the standard MIMO version, including a specific firmware upgrade with tailored DSP resources for automix and conference purposes. Included in EclerNet Manager pack. Compatible with MIMO88, MIMO88SG and MIMO1212SG.

## KEY FEATURES

- AUTOMIXER processing module:
  - NOMA ("Number of Open Microphones Attenuated")
  - EXCLUSIVE
- Full set of working parameters: MAX. NOMA, LAST ON, PRIORITY, THRESHOLD DEPTH, etc.
- FEEDBACK KILLER (2 modules)
  - 2 automatic notch filter banks
  - 8 notch filters included in each bank
  - Fixed / dynamic filters free configuration
  - Filter WIDTH, RECYCLE TIMER, LOCK, RESET and BYPASS parameters
  - 4 working mode presets

## APPLICATIONS



Digital Matrixes & Processors





# HUB1408 / 1616

Digital Zoner



HUB1408



HUB1616



## ACCESSORIES



eMPAGE



WPaMIX-T



eMCONTROL1

**HUB1408/ HUB1616** is a digital audio zoner programmable through integrated web server (HANGAR), with multiple control functions. Intuitive and easy to configure thanks to its Predefined Setups.

## KEY FEATURES

- Programming and control by integrated web server HANGAR and standard web browser (no additional software required)
- Control from the front panel and user remote control by:
  - eMCONTROL1 wall panels (up to 8)
  - eMPAGE paging consoles (up to 2)
  - Ecler pilot application, compatible with Android and iOS: control graphic panels set to user requirements
  - TP-NET protocol for control and integrating with third party systems
- Control available, by zone (output): selection of audio source (input), volume adjustment and MUTE, and 3 band tone adjustment
- Audio over audio priority function with two levels: inputs MIC/LINE attenuate or completely mute the sound content present (programme audio) in specific target zones: emergency messages, warnings, etc., in Talkover mode or Pager
- MUTE port can be activated by closing the external dry contact, affecting programmed outputs to this effect
- Available DSP: frequency shifter, link stereo, delay, crossover filters, graphic EQ, compressor/limiter and much more

	HUB1408	HUB1616
Inputs	4 MIC/LINE + 2 ST LINE + 8 Remote Mono LINE	4 MIC/LINE + 4 ST LINE + 8 Remote Mono LINE
Outputs	8 Bal. (Euroblock)	16 Bal. (Euroblock)
Communication Interfaces	1 Ethernet + 1 RS232	1 Ethernet + 1 RS232
Remote control	8 ports (RJ45)	8 ports (RJ45)
Dimensions (WxHxD)	482,6x88(2RU)x200mm / 19"x3.46"x7.87"	482,6x88(2RU)x200mm / 19"x3.46"x7.87"
Weight	3,7 kg / 8.16 lb	3,7 kg / 8.16 lb

## APPLICATIONS



Digital Matrixes & Processors



# Ecler PILOT

Android/iOS Application

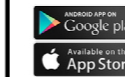

Ecler Pilot

Scalable & editable panels (compatible with smartphones, tablets & desktop devices)

Ecler Pilot

Multi user control system

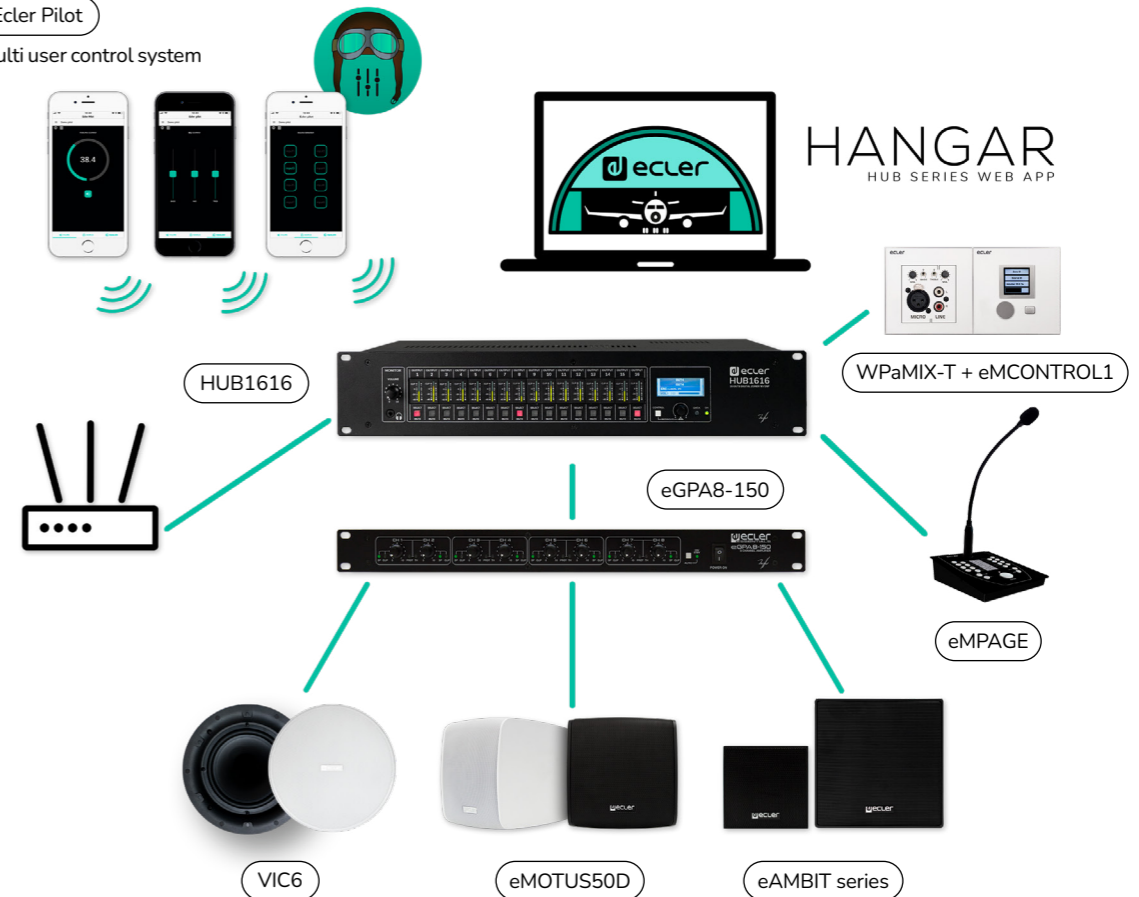

**Ecler pilot** is an end-user remote control application to manage one or several installation zones. Each end-user grants a customised access via his/her credentials, getting access to a closed list of control panels which have been previously decided by the HUB Administrator. Each control panel can include volume & mute controls and/or audio sources selection keys and/or 3-band tone controls.

Digital Matrixes & Processors





# DAM614

Digital Mixer



EclerCOMM Manager



DAM614



## ACCESSORIES



MPAGE4



ETH232AD



WPa Series



WPaMIX-T

**DAM614** is a fully programmable audio digital mixer. It includes 6 audio inputs and 4 audio outputs, front panel inputs and outputs level controls. Its 4 outputs can be used as mono independent zones or coupled as stereo zones. Regarding inputs, the first 2 are stereo LINE inputs, and the 3rd, 4th, 5th and 6th ones are MIC/LINE ready, being possible to use them independently (mono) or as stereo-coupled inputs.

### KEY FEATURES

- DSP @ 24 bits / 48kHz
- Front panel LCD display
- 6 front panel input control digital knobs (one per input)
- 4 front panel output control digital knobs (one per output)
- 4 front panel keys, for parameters adjustment and menus navigation
- Processing:
  - Independent level control for each input and output
  - Independent mixer for each output zone
  - Crossover filters available for each output
  - Independent 10 band graphic EQ for each output
  - Independent and adjustable High-pass filter available for MIC/LINE inputs
  - 2 level priority PAGER / DUCKER function, triggered by MIC/LINE inputs
  - Independent Noise Gate function for MIC/LINE inputs
  - Independent Feedback Suppressor Function for MIC/LINE inputs
  - Adjustable delay time for 2 outputs

	DAM614
Inputs	2 ST LINE + 4 MIC/LINE
Outputs	4 BaL. (Euroblock)
Communication Interfaces	1 RS232 (EclerCOMM & CA-NET)
Remote control	4 RJ45 ports (0-10VDC) + 1 MUTE
Dimensions (WxHxD)	482,6x44(1RU)x120mm / 19"x1.73"x4.72"
Weight	2,0 kg / 4.41 lb

### APPLICATIONS



Digital Matrixes & Processors



# DN44BOB

Dante™ Digital Interface

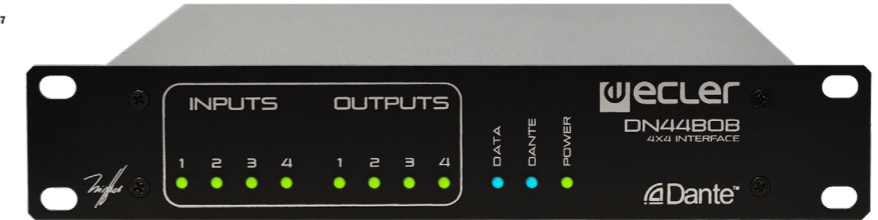

DN44BOB

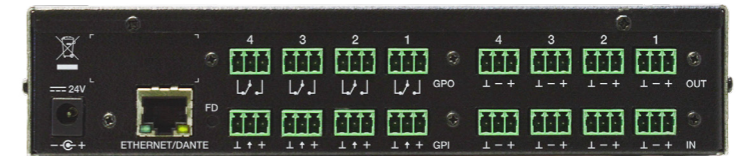

## ACCESSORIES



MPAGE1r



WPaMIX-T

**DN44BOB** is a 4 inputs and 4 outputs DANTE (Audio Over IP) Break Out Box. It allows to convert 4 analogue audio signals into 4 DANTE channels and send them into an Ethernet LAN, as well as to take 4 DANTE channels from the Ethernet network and convert them to analogue audio signals.

### KEY FEATURES

- Ethernet, interface, DANTE audio and EclerNet compatible
- 4 MIC/LINE balanced inputs, with Phantom Power and 3 sensitivity levels, Euroblock connector
- 4 balanced LINE Outputs, Euroblock connector
- 4 GPI ports (0-10VDC)
- 4 GPO ports, NO / NC
- Rack-mount kit included: 1UHRMKIT + PUM3

	DN44BOB
Inputs	4 MIC/LINE BaL. (Euroblock)
Outputs	4 BaL. (Euroblock)
Communication Interfaces	1 Ethernet (Dante audio & EclerNet)
Remote control	4 GPI + 4 GPO
Dimensions (WxHxD)	241x44(1RU)x152mm / 9.48"x1.73"x5.98"
Weight	1,1 kg / 2.42 lb

### APPLICATIONS



Digital Matrixes & Processors





# ALMA24 / 26

Digital Loudspeaker Managers



ALMA24



ALMA26



Digital Matrixes & Processors



## 3rd PARTY CONTROL DRIVERS

AVAILABLE



### ACCESSORIES



WPaVOL

ALMA24/ALMA26 is a digital loudspeaker manager in a 1RU stand-alone processor.

### KEY FEATURES

#### ALMA24:

- 24 bits / 48 kHz DSP processing
- USB interface and EclerCOMM Manager compatibility
- DSP processing:
  - GAIN, MUTE, POLARITY, etc., per input or output
  - 8 parametric EQ filters per input / 8 parametric EQ filters per output
  - Butterworth, Linkwitz-Riley or Bessel Crossover filters at inputs and outputs (up to 48 dB / oct)
  - Inputs and outputs delay
  - Peak & RMS compressor / limiter at inputs & outputs, including make-up gain
  - 2 LINK groups (output channels link)

#### ALMA26:

- 24 bits / 48 kHz DSP processing
- 2x20 characters front panel LCD display
- 4 front panel configuration keys + digital encoder
- USB interface and EclerCOMM Manager compatibility
- DSP processing:
  - GAIN, MUTE, POLARITY, etc., per input or output
  - 4 parametric EQ filters per input / 8 parametric EQ filters per output
  - Butterworth, Linkwitz-Riley or Bessel Crossover filters at outputs (up to 48 dB / oct)
  - Inputs and outputs delay
  - Compressor / limiter at outputs, including make-up gain
  - 3 LINK groups (output channels link)



	ALMA24	ALMA26
Inputs	2 XLR	2 XLR
Outputs	4 XLR	6 XLR
Communication Interfaces	2 GPI	2 GPI
Remote control	No	Yes
Dimensions (WxHxD)	482,6x44(1RU)x120mm / 19"x1.73"x4.72"	482,6x44(1RU)x120mm / 19"x1.73"x4.72"
Weight	1,8 kg / 3.97 lb	1,8 kg / 3.97 lb

### APPLICATIONS



## WE INCREASE COMPATIBILITY WITH OTHER BRANDS

Programming control system will no longer be a headache. Even if you don't know the TP-NET / CA-NET protocols, you can now easily install any control system in your project.

*Multiply integration options and user friendly configurations.*

ecler.com



# VIDA Series

Digital Amplifiers



VIDA-48Q

VIDA-24Q

VIDA-16Q



## ACCESSORIES



WPaVOL



WPaMIX-T



WPaBT

The awarded **VIDA Series** of Amplifiers exemplifies Ecler's dedication to innovation, superior sound quality, versatility and sustainability. Pioneering VersaPower technology empowers users to effortlessly optimize their sound systems. By distributing all the power to a single output or across multiple channels asymmetrically, users can customize their audio setup to meet the specific requirements of any installation in both high and low impedance lines. They offer a comprehensive range of connectivity and advanced DSP options, ensuring compatibility with various audio sources and systems.

VIDA Series features managing capabilities including Ecler VIDA App to make both users and installers' lives easier, controlling several VIDA devices from the same app at the same time. The VIDA Web GUI Embedded Application available in 7 languages, eliminates the need for additional software installations, saving valuable time.

## KEY FEATURES

- 4 VersaPower amplified outputs with asymmetrical power management
- 4 Dante™/ AES67 outputs and 4 Dante™/ AES67 inputs
- 2 auxiliary outputs
- 4 analogue inputs
- MicroSD/SDHC audio player
- Internal matrix and signal processing
- Web application for device configuration
- Smart power management VersaPower
- Control and scheduled events for automation
- Customize user panels
- Remote control user application for iOS/Android/Web
- Ultra low power consumption mode

## APPLICATIONS



Amplifiers



**Best Product 2023**  
for retail, restaurants and hotels.

**THE AWARD**  
THE PROAV AWARD GERMANY



	VIDA-16Q	VIDA-24Q	VIDA-48Q
<b>Inputs</b>	4 analog input channels + 4 DANTE/AES67 Network Receivers + 1 embedded player + 1 embedded signal generator		
<b>Outputs</b>	4 Amplified Outputs   Output mode selection per channel Lo-Z/ Hi-Z, 70V/100V, 4Ω/8Ω/2Ω. Rear panel DIP SWITCH selectors + 2 Auxiliary Line Level Outputs   4 DANTE/AES67 Network Transmitters		
<b>Total Max Output Power All Channel Driven</b>	1600W (VersaPower)	2400W (VersaPower)	4800W (VersaPower)
<b>Dimensions (WxHxD)</b>	482,6x88x410 mm / 19"x3,46"x16,14"	482,6x88x410 mm / 19"x3,46"x16,14"	482,6x88x410 mm / 19"x3,46"x16,14"
<b>Weight</b>	9,3 kg / 20,5 lb	9,3 kg / 20,5 lb	9,3 kg / 20,5 lb



# HADA Series

Networkable Amplifiers

HADA-4B150

HADA-4B250

HADA-4B400

HADA-4B500

HADA-4B750

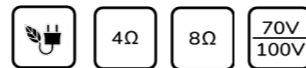

## ACCESSORIES



WPaVOL



WPaMIX-T



WPaBT

HADA Series of Networkable Amplifiers are the perfect choice for multiple types of set ups and a wide range of applications with intuitive control capabilities. This new Series incorporates Class D, Standby Mode, power factor correction and are ready to perform in high or low impedance lines, per couple of channels. The full family feature 4 outputs and DSP functionalities configured via Ecler HADA DSP Manager including 10 band parametric EQ, multiband compressor, delay, limiter, a 4 by 4 mixer matrix to route the signals and saving or loading up to 100 presets.

## KEY FEATURES

- 4 analogue inputs on Euroblock connectors
- 4 GPI for remote volume control
- 1 External Mute
- Internal matrix mixer and signal processing
- HADA DSP Manager software for device configuration and control
- Thermal, DC, HF and over current protection
- Third party control via TCP/IP

	HADA-4B150	HADA-4B250	HADA-4B400
Inputs	4 analog input channels		
Outputs	4 Amplified Outputs   Output mode selection by channel pairs Lo-Z/Hi-Z, 70V/100V, 4Ω/8Ω by HADA DSP Manager Software		
Max output power @ 4Ω Single Channel Driven @1kHz	125W	250W	400W
Max output power Bridge @8Ω All channel driven @1kHz	250W	500W	800W
Dimensions (WxHxD)	482,6x88x281,5mm / 19"x3.46"x11.08"	482,6x88x281,5mm / 19"x3.46"x11.08"	482,6x88x281,5mm / 19"x3.46"x11.08"
Weight	4.7 Kg / 10.36 lb	5.0 Kg / 11.02 lb	5.4 Kg / 11.91 lb

## APPLICATIONS



Amplifiers

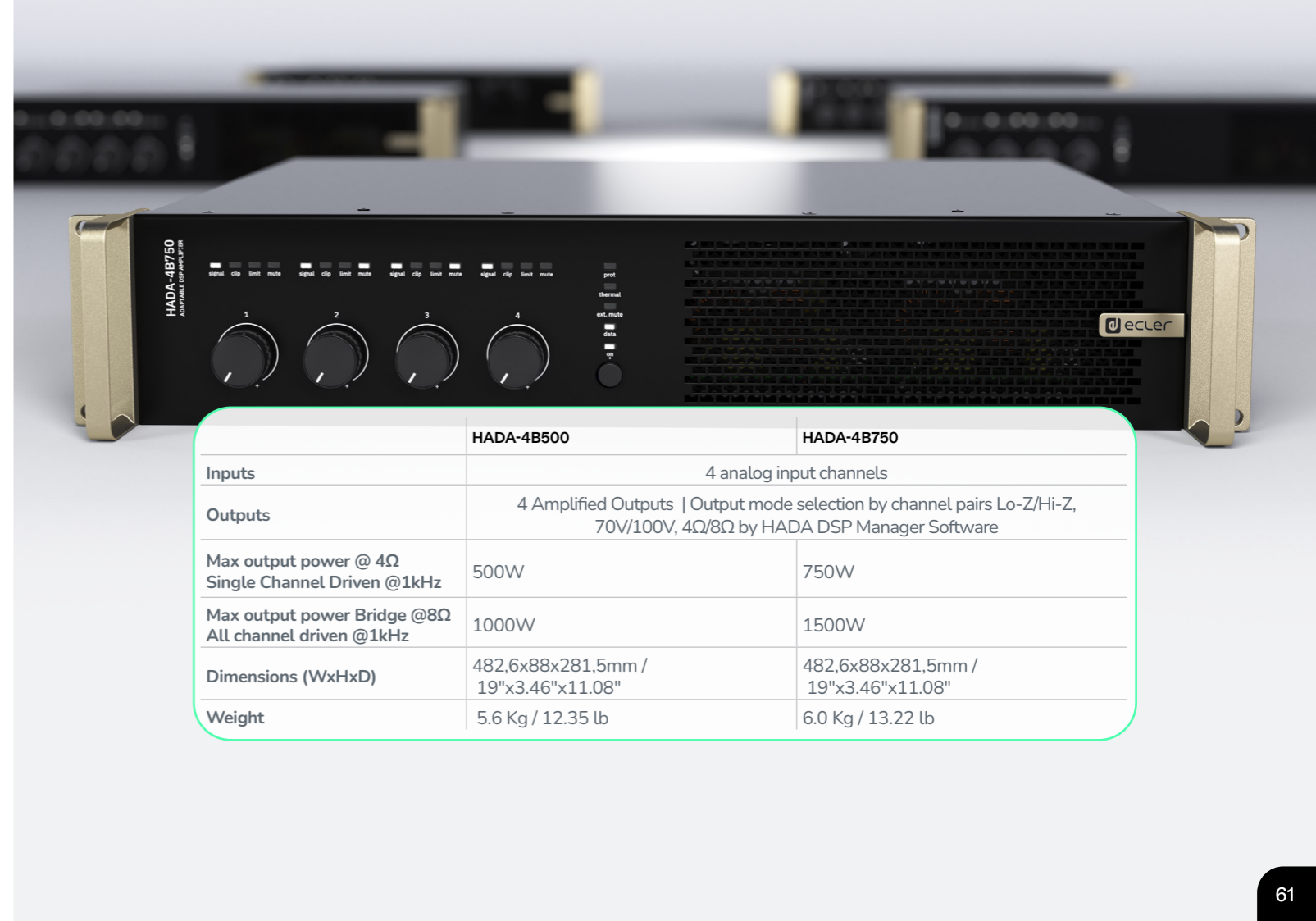

	HADA-4B500	HADA-4B750
Inputs	4 analog input channels	
Outputs	4 Amplified Outputs   Output mode selection by channel pairs Lo-Z/Hi-Z, 70V/100V, 4Ω/8Ω by HADA DSP Manager Software	
Max output power @ 4Ω Single Channel Driven @1kHz	500W	750W
Max output power Bridge @8Ω All channel driven @1kHz	1000W	1500W
Dimensions (WxHxD)	482,6x88x281,5mm / 19"x3.46"x11.08"	482,6x88x281,5mm / 19"x3.46"x11.08"
Weight	5.6 Kg / 12.35 lb	6.0 Kg / 13.22 lb



# NXA Series

Powered Digital Audio Managers



NXA4-400



NXA6-200

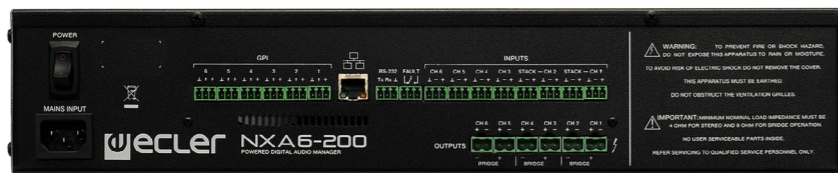

4Ω 8Ω

## ACCESSORIES



WPNETTOUCH



WPNET4K/8K



WPa Series

NXA is a series of a powered digital audio managers that stays halfway between a digital matrix and a multichannel amplifier. An "all-in-one" digital audio device that becomes a complete audio solution.

## KEY FEATURES

- NXA4-80 / NXA4-200 / NXA4-400 models: 4 analogue audio inputs x 4 powered audio outputs (80/200/400 W per channel, respectively). 4 GPI ports
- NXA6-80 / NXA6-200 models: 6 analogue audio inputs x 6 powered audio outputs (80/200 W per channel, respectively). 6 GPI ports
- Class D amplifiers (eco friendly)
- Auto stand-by function (eco friendly)
- 100% silent (fanless convection cooling system)
- Health self-test mode function, with FAULT RELAY (for an external redundancy system)
- Integrated anti-clip system
- Integrated DSP processor. Main features:
  - Inputs mixer independent per channel (all inputs available)
  - VOLUME, MUTE, SOLO, PHASE INVERSION, MAX. VOL limit and MIN.VOL limit, LP and HP Crossover filters, parametric EQ filters bank, Ducker, Delay, Compressor and more settings configurable per channel
  - Ethernet interface, compatible with EclerNet Manager platform and UCP remote control system
  - RS232 Interface
  - TP-NET third-party remote control (compatible with CRESTRON®, AMX®, RTI®, VITY®, etc.

	NXA4-80	NXA4-200
1 channel @ 4Ω (RMS)	85W	202W
1 channel @ 8Ω (RMS)	51W	121W
All channels @ 4Ω (RMS)	66W	168W
2 bridged channels @ 8Ω (RMS)	160W	383W
Dimensions (WxHxD)	482,6x88(2RU)x373mm / 19"x3.46"x14.68"	482,6x88(2RU)x373mm / 19"x3.46"x14.68"
Weight	8,6 kg / 18.96 lb	11,1 kg / 24.47 lb

## APPLICATIONS



NXA4-80



NXA4-200



NXA4-400



NXA6-80



NXA6-200



	NXA4-400	NXA6-80	NXA6-200
1 channel @ 4Ω (RMS)	416W	84W	218W
1 channel @ 8Ω (RMS)	230W	49W	126W
All channels @ 4Ω (RMS)	330W	65W	163W
2 bridged channels @ 8Ω (RMS)	760W	158W	399W
Dimensions (WxHxD)	482,6x88(2RU)x373mm / 19"x3.46"x14.68"	482,6x88(2RU)x373mm / 19"x3.46"x14.68"	482,6x88(2RU)x373mm / 19"x3.46"x14.68"
Weight	15,6 kg / 34.39 lb	10,2 kg / 22,49 lb	12,9 kg / 28.43 lb





# AURA Series

Commercial Amplifiers

AURA-2L150

AURA-2H150

AURA-4L150

AURA-4H150

AURA-8L150



AURA-4H150



AURA-2L150 / 4L150 / 8L150:



AURA-2H150 / 4H150:



AURA Series are built with the highest robustness for long lasting performances, with special power supply circuitry designed for optimized electrical consumption. All AURA are 100% silent featuring convection cooling system. AURA Series also features the possibility of linking channels to the first input by selecting it on the rear panel, auto stand-by, overload and thermal protection, PFC and anti-clipping system.

## KEY FEATURES

- Euroblock input and output connectors
- High efficiency (class D)
- Adjustable Auto Stand-by Level
- Convection cooling (fanless, 100% silent)
- Thermal protection
- Overload protection
- Anti-clip system

	AURA-2L150	AURA-2H150	AURA-4L150
Inputs	2 analogue inputs	2 analogue inputs	4 analogue inputs
Output configuration	2x150 W RMS @ 4Ω	2 x150 WRMS @ 70V / 100V	4x150 W RMS @ 4Ω
Dimensions (WxHxD)	482,6x44x277 mm / 19"x1,73x10,9"	482,6x44x277 mm / 19"x1,73x10,9"	482,6x44x277 mm / 19"x1,73x10,9"
Weight	3,0 kg / 6,6 lb	5,8 kg 12,8 lb	3,7 kg 8,16 lb

## APPLICATIONS



	AURA-4H150	AURA-8L150
Inputs	4 analogue inputs	8 analogue inputs
Output configuration	4 x150 WRMS @ 70V / 100V	8x150 W RMS @ 4Ω
Dimensions (WxHxD)	482,6x44x414 mm / 19"x1,73"x16,29"	482,6x44x414 mm / 19"x1,73"x16,29"
Weight	10,2 kg 22,5 lb	6,3 kg 13,9 lb





# eLPA Series

Stereo Amplifiers



eLPA2-350



4Ω 8Ω

eLPA is a stereo amplifier series delivering 350/650/950/1400 W. eLPA series brings all the classic, well-known reliability and amplification quality of ECLER to a new light-weight format that is versatile and affordable.

## KEY FEATURES

- 2 analogue audio inputs x 2 powered audio outputs
- Ultra light technology
- Built-in crossover filter (eLPA2-350)
- Efficient progressive ventilation system
- Rotary input attenuation controls that are easily accessible on the front panel
- POWER ON, SIGNAL, CLIP y PROTECT LED indicators
- Efficient short-circuit, overheat and DC signal protection system
- Permanently activated built-in anti-clip circuit
- Balanced inputs via XLR3 connectors. In addition, eLPA2-350 model includes Jack 6,35mm and RCA inputs.
- Amplified outputs with terminal-type connectors and Speakon® connectors

	eLPA2-350	eLPA2-650
1 channel @ 4Ω (RMS)	345W	630W
1 channel @ 8Ω (RMS)	200W	340W
2 Bridged Channels @ 8Ω (RMS)	560W	1220W
Internal crossover	Yes	No
Dimensions (WxHxD)	482,6x88(2RU)x266mm / 19"x3.46"x10.47"	482,6x88(2RU)x266mm / 19"x3.46"x10.47"
Weight	5,5 kg / 12.12 lb	6,0 kg / 13.23 lb

## APPLICATIONS

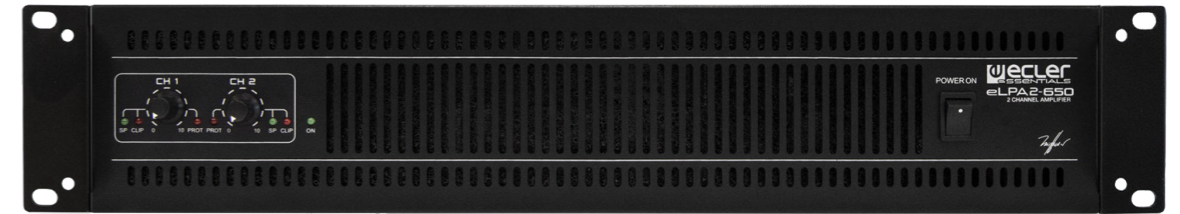

eLPA2-650



eLPA2-950

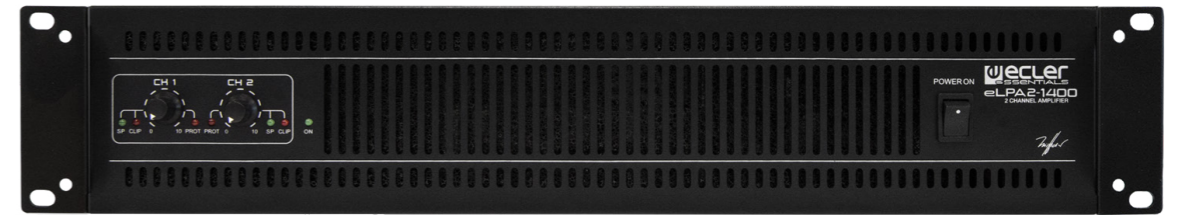

eLPA2-1400



4Ω 8Ω

	eLPA2-950	eLPA2-1400
1 channel @ 4Ω (RMS)	950W	1400W
1 channel @ 8Ω (RMS)	500W	770W
2 Bridged Channels @ 8Ω (RMS)	1840W	2600W
Internal crossover	No	No
Dimensions (WxHxD)	482,6x88(2RU)x266mm / 19"x3.46"x10.47"	482,6x88(2RU)x304mm / 19"x3.46"x11.97"
Weight	6,2 kg / 13.67 lb	6,3 kg / 13.89 lb



# eGPA2-300

Multichannel Amplifiers

Amplifiers



eGPA2-300

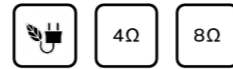

## ACCESSORIES



CNXEBLINK4

eGPA2-300 is a stereo amplifier (class D) series. Auto stand-by function and fanless design, 100% silent. Thermal and overload protections. Anti-clip system.

### KEY FEATURES

- Euroblock input and output connectors
- High efficiency, auto standby function and convection cooling (fanless, 100% silent)
- BRIDGE mode ready
- Thermal protection
- Overload protection
- Anti-clip system

	eGPA2-300
1 channel @ 4Ω (RMS)	310W
1 channel @ 8Ω (RMS)	165W
All channels @ 4Ω (RMS)	310W
2 bridged channels @ 8Ω (RMS)	600W
Dimensions (WxHxD)	482,6x44(1RU)x221mm / 19"x1.73"x8.7"
Weight	3,4 kg / 7.49 lb

### APPLICATIONS



# GPA Series

High-efficiency Stereo Amplifiers

Amplifiers



GPA2-400ES



GPA2-800

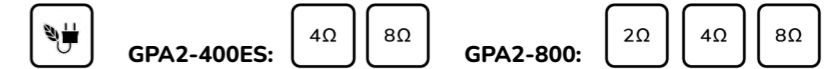

## ACCESSORIES



WPa Series

GPA is a series of stereo amplifiers that become a perfect and affordable option in many audio projects. A very high efficiency and an auto standby function provide these amplifiers with a true green profile.

### KEY FEATURES

- 2 analogue audio inputs x 2 powered audio outputs
- Euroblock output and speakon connectors
- 2 REMOTE volume ports (0-10VDC), compatible with WPa series wall panels
- High efficiency, auto standby function and convection cooling (fanless, 100% silent)
- BRIDGE mode ready
- Thermal protection
- Overload protection
- Anti-clip system
- Volume control knobs on front panel with protection cap, against undesired manipulation

	GPA2-400ES	GPA2-800
1 channel @ 2Ω (RMS)	-	1000W
1 channel @ 4Ω (RMS)	390W	640W
1 channel @ 8Ω (RMS)	280W	347W
2 bridged channels @ 8Ω (RMS)	700W	1150W
Dimensions (WxHxD)	482,6x88(2RU)x373mm / 19"x3.46"x14.68"	482,6x88(2RU)x423mm / 19"x3.46"x16.65"
Weight	10,4 kg / 22.93 lb	13,5 kg / 29.76 lb

### APPLICATIONS





# HSA-400ES

High Impedance Amplifiers



HSA2-400ES



## ACCESSORIES



WPa Series

**HSA2-400ES** is a stereo amplifier with low and high impedance powered outputs.

### KEY FEATURES

- 2 mono balanced inputs (XLR and Euroblock terminals)
- 2 x 400 W RMS output (4Ω and 70/ 100V line level)
- Euroblock output connectors
- 2 REMOTE volume ports (0-10VDC), compatible with WPa series wall panels
- Energy Star® Certification
- High efficiency, auto stand-by function and convection cooling (fanless, 100% silent)

	HSA2-400ES
1 channel @ 70/100V(RMS)	450W
1 channel @ 4Ω (RMS)	390W
1 channel @ 8Ω (RMS)	280W
Dimensions (WxHxD)	482,6x88(2RU)x373mm / 19"x3.46"x14.68"
Weight	16,4 kg / 36.15 lb

### APPLICATIONS



Amplifiers



# eHSA Series

High Impedance Multichannel Amplifiers

Amplifiers



eHSA4-60



eHSA2-500



eHSA4-500



eHSA4-60: 4Ω 70V/100V eHSA2-500/eHSA4-500: 70V/100V

eHSA is a multichannel amplifier with high impedance powered outputs. They are lightweight, versatile and affordable amplifiers.

### KEY FEATURES

- High efficiency, auto stand-by function and convection cooling (fanless, 100% silent)
- Volume control knobs on front panel
- High and low impedance outputs (eHSA4-60 only)
- Link-channel buttons: allows to replicate the input channel signal in the adjacent one (eHSA4-60 only)
- 2 mono balanced inputs (Euroblock terminals) with stack outputs
- Selectable HPF (Cut-off freq. = 75Hz)
- Volume control trimmers on rear panel
- Thermal protection
- Overload protection
- Anti-clip system

	eHSA4-60		eHSA2-500	eHSA4-500
1 channel @ 4Ω 70/100V (RMS)	60W	1 channel @ 100V	500W	500W
All channels @ 4Ω 70/100V (RMS)	60W	All channels @ 100V	500W	450W
Dimensions (WxHxD)	482,6x44(1RU) x280mm / 19"x1.73x11.21"	Dimensions (WxHxD)	482,6x88(2RU) x365mm / 19"x3.46"x14.37"	482,6x88(2RU) x365mm / 19"x3.46"x14.37"
Weight	7,8 kg / 17.19 lb	Weight	6,3 kg / 13.89 lb	7,6 kg / 16.75 lb

### APPLICATIONS





# HZA4-120F

Flexi-power Amplifier



HZA4-120F



100V

## ACCESSORIES



WPa Series

HZA4-120F is a four MERGING channel amplifier with direct 100 V line (high impedance) outputs. It integrates ECLER's proprietary SPM 100 Technology - Channel N.

### KEY FEATURES

- 4 mono balanced inputs
- 4 amplified outputs (100V line level)
- 4 volume remote control ports (0 - 10 VDC)
- Euroblock connectors
- SPM 100 amplification Technology - Channel N (no 100 V output transformers used):
  - Improved frequency response (specially at the low-end)
  - Convection cooling (100% silent and increased reliability)
- Great efficiency
- Low weight
- Auto stand-by function after 2 minutes without audio input signals, with instantaneous auto-recovery
- Thermal protection
- Overload protection
- Anti-clip system
- Volume control knobs on front panel with protection cap, against undesired manipulation
- Every 2, 3 or 4 adjacent channels can be merged, adding their output power and managing their signal routing and volume control as a single merged channel

	HZA4-120F
1 channel @ 100V(RMS)	114W
2 merged channels @ 100V (RMS)	195W
3 merged channels @ 100V (RMS)	290W
4 merged channels @ 100V (RMS)	356W
Dimensions (WxHxD)	482,6x88(2RU)x392mm / 19"x3.46"x15.43"
Weight	13,6 kg / 29.98 lb

### APPLICATIONS



Amplifiers



# eHMA Series

Mixing Amplifiers



eHMA60



eHMA120



eHMA250



4Ω

70V  
100V

## ACCESSORIES



MPAGE1r

### eHMA250:



WPa Series

eHMA series is the perfect integral solution for budget and user-friendly professional audio projects.

### KEY FEATURES

- Mixer + amplifier
- MIC & MIC/LINE inputs
- High & Low impedance outputs
- Auto-standby function
- Fanless, 100% silent
- Talkover function available
- 2-band tone controls for mix output
- MUTE port
- External power supply included (eHMA60 and eHMA120)
- Rack mount kit included

	eHMA60	eHMA120	eHMA250
1 channel @ 4Ω (RMS)	66W	95W	250W
1 channel @ 70/100V(RMS)	60W	95W	250W
Inputs	2 MIC/LINE + 1 MIC	2 MIC/LINE + 1 MIC + 1 LINE	2 MIC/LINE + 2 MIC + 2 LINE
Outputs	1 Hi-Z + 1 Lo-Z	2 Hi-Z + 1 Lo-Z + 1 AUX/REC	4 Hi-Z + 1 Lo-Z + 1 AUX/REC
Dimensions (WxHxD)	200x44(1RU)x150mm / 7.87"x1.73"x5.90"	435x44(1RU)x120mm / 17.13"x1.73"x4.72"	435x44(1RU)x220mm / 17.13"x1.73"x8.7"
Weight	1,9 kg / 4.18 lb	2,9 kg / 6.39 lb	3 kg / 6.61 lb

### APPLICATIONS



Amplifiers





# HMA120

Mixing Amplifiers

Amplifiers



HMA120



## ACCESSORIES



2UHRMKIT



MPAGE1r



WPa Series

HMA120 is a self-powered mixer including an integrated media player.

### KEY FEATURES

- 2 balanced microphone input mixable with the selected music program (MIC1 and MIC2/LINE ST inputs)
- 3 line inputs for music sources
- Integrated audio player (supporting mp3 format) with USB and SD CARD slots for media storage devices
- Music program selector on the front panel: LINE1, LINE2, LINE3, MEDIA (integrated player)
- Noise gate and two-level priority system (Talkover 1 and Talkover 2) for MIC1 and MIC2/LINE inputs
- Independent level controls on the front panel for MIC1, MIC2/LINE and MUSIC signals
- 2-band EQ (BASS/TREBLE) for MIC1 and MIC2/LINE and 2-band EQ for program MUSIC signal
- REMOTE port for connecting WPa series wall panels, 0 - 10VDC (source selection and volume)
- MUTE port to remotely mute the unit from an external device, via dry contact closure
- Auxiliary Output
- Auto Stand-by function

	HMA120
1 channel @ 8Ω (RMS)	84W @ 8Ω / 110W @ 4Ω
1 channel @ 70/100V(RMS)	110W
Inputs	3 LINE + 1 MIC/LINE + 1 MIC + Media player (USB + SD)
Outputs	1 Hi-Z + 1 Lo-Z + 1 AUX
Dimensions (WxHxD)	210x88(2RU)x230mm / 8.26"x3.46"x9.05"
Weight	6,0 kg / 13.23 lb

### APPLICATIONS



# eCA Series

Compact Amplifiers

Amplifiers



eCA120

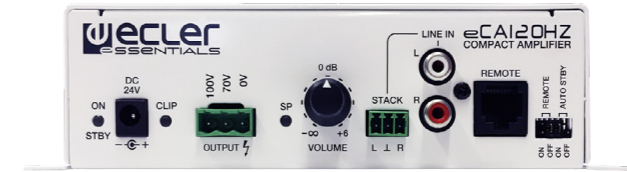

eCA120HZ



eCA120

eCA120HZ



## ACCESSORIES



WPa Series

eCA120/eCA120Hz is a stereo micro-amplifier, in a very compact format and a light and silent (fanless) design.

### KEY FEATURES

- External, universal power supply (CE/UL/CCC)
- AUTO STANDBY function: in the absence of an audio signal the unit automatically goes into STANDBY mode, minimizing power consumption
- Light and silent (fanless) design
- 1 unbalanced stereo line input (LINE IN / STACK), with dual RCA connector and 3-pin Euroblock connector
- Local volume control by knob
- Remote volume control by WPa series wall panel (0-10VDC)

	eCA120	eCA120HZ
1 channel @ 4Ω (RMS)	68W	-
1 channel @ 70/100V(RMS)	-	106W
Inputs	1 LINE ST	1 LINE ST
Remote control	1 RJ45	1 RJ45
Dimensions (WxHxD)	190x48x90mm / 7.48"x1.89"x3.54"	190x48x190mm / 7.48"x1.89"x7.48"
Weight	600 g / 1.32 lb	2,3 kg / 5.07 lb

### APPLICATIONS





# CA Series

Compact Amplifiers



Amplifiers



CA Series remote controller



CA40

CA120

CA120HZ



CA40/120: 4Ω



CA120HZ: 70V/100V



## ACCESSORIES



ETH232AD



MPAGE1r



WPa Series

CA40/CA120/CA120HZ is a stereo amplifier with a tiny size but amazing remote control features: serial RS-232 port, IR receiver and 0-10 VDC remote port. It's an ideal solution in those audiovisual applications which require integration with external control devices: education classrooms, meeting rooms, multimedia presentations, retail shops, etc.

## KEY FEATURES

- Compact amplifier
- Digital local control, encoder type
- Infrared remote control included
- Remote control compatible with WPaVOL and WPaVOL-SR wall panels (0-10 VDC)
- RS-232 control port compatible with EclerCOMM software and CA-NET protocol
- MUTE port for external muting of the unit when an evacuation system must be activated
- Presets / sources management via RS-232 or 0-10 VDC remote control port
- AUTO STANDBY function
- Light and silent (fanless) design

	CA40	CA120	CA120HZ
1 channel @ 4Ω (RMS)	22W	68W	-
1 channel @ 70/100V(RMS)	-	-	96W
Inputs	2 LINE ST + 1 MIC	2 LINE ST + 1 MIC/LINE ST	2 LINE ST + 1 MIC/LINE ST
Remote control	1 RJ45 + IR + RS232 (EclerCOMM & CA-NET)	1 RJ45 + IR + RS232 (EclerCOMM & CA-NET)	1 RJ45 + IR + RS232 (EclerCOMM & CA-NET)
Dimensions (WxHxD)	155x45x155mm / 6.10"x1.77"x6.10"	160x48x210mm / 6.29"x1.88"x8.26"	160x48x325mm / 6.29"x1.88"x12.79"
Weight	650 g / 1.43 lb	950 g / 2.09 lb	2,9 kg / 6.39 lb

## APPLICATIONS



# EclerCLOUD

## Your Gateway to Ultimate Control and Monitoring!

Track device status, take a Deep Dive to manage audio inputs and outputs, and adjust settings with ease — all from anywhere, at any time. Simplify your management with device grouping and intuitive navigation.





# NIMBO Series

High Performance Loudspeakers



**NIMBO Series** is a premium performance loudspeaker family featuring outstanding sound quality. Suitable for outdoor applications, with a compact and cloud-inspired design, (result) of Ecler's engineering prowess. The three models available can be personalized to the customer's colour preferences. The whole series includes wall bracket, allowing tilt and swivel adjustment using a single screw.

## KEY FEATURES

- 2-way passive loudspeaker for surface mounting
- Woofers with 4-layer voice coil improves power handling and low frequency response
- 1" silk tweeter with neodymium magnet and ferrofluid.
- ABS reinforced with fiberglass non resonant compact enclosure
- Wide dispersion pattern
- Stack Output
- Wall-mount bracket included. Quick and easy to install, including jumps and markings for repeating speaker orientation
- Weather-protected with an IP44 rating
- Available in white (RAL9003), black (RAL9005) and gold colour (RAL1036, approx.)
- RAL paint customization available
- Ecler Loudspeakers EQ Settings available
- EASE files available

	NIMBO-14	NIMBO-24	NIMBO-26
RMS power / Peak power	40 W RMS / 160 W Peak	80 W RMS / 320 W Peak	140W RMS / 560 W Peak
Woofer / tweeter	4" / 1" Silk Dome Tweeter	2x4" / 1" Silk Dome Tweeter	2x6,5" / 1" Silk Dome Tweeter
Nominal Impedance	8Ω	4Ω / 16Ω	4Ω / 16Ω
Dimensions (WxHxD)	250 x 148.7x 150 mm / 9.84 x 5.85 x 5.91 in	370 x 180 x 180 mm / 14.56 x 7.08 x 7.08 in	542.5 x 261 x 269 mm / 21.36 x 10.28 x 10.59 in
Weight	1.7 kg / 3.75 lb	3 kg / 6.61 lb	8.5 Kg / 18.74 lb

## APPLICATIONS





# DROP6

Pendant Loudspeaker



DROP6

**DROP6** is a 6.5" 75W @ 8Ω 2-way pendant loudspeaker with a stylish design, featuring a 70/100V line transformer with 60/30/15 and 7.5W power selections, available in high and low impedance levels.

## KEY FEATURES

- Two-way full-range pendant loudspeaker
- 75 W RMS @ 8Ω
- 6.5" woofer / 1" tweeter
- Compatible for use in high impedance (70V or 100V line) and low impedance (8Ω)
- Power selector: 4 options of 60W/30W/15W/7.5W in high impedance or one 75W option in low impedance
- ABS reinforced with fibreglass
- Paintable grille and speaker (white)
- INPUT/LINK double connector, Euroblock type
- Cable length: 5m (includes 2 height adjustable steel cords)
- Available in white (RAL9003) and black (RAL9005)

	DROP6
RMS power / Peak power (8Ω)	75W / 300W
Woofer / tweeter	6.5" Woofer + 1" Tweeter
Power selector @ 70/100V	7.5W - 15W - 30W - 60W
SPL 1W/1m	88 dB
Dimensions	Ø270mm x 355mm(H) / Ø10.6 in. x 14 in. (H)
Weight	4.2 Kg / 9.26 lb

## APPLICATIONS



Loudspeakers



# ARQISi Series

Architectural Wooden Cabinets

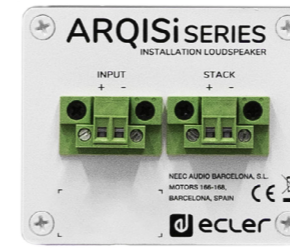

ARQIS105i / 106i  
Connection plate



ARQIS105i / 106i / 108i  
VEASY Wall bracket (included)



ARQIS108i Connection plate

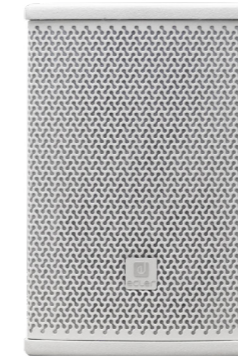

ARQIS105i

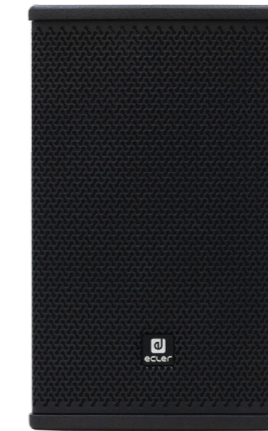

ARQIS106i

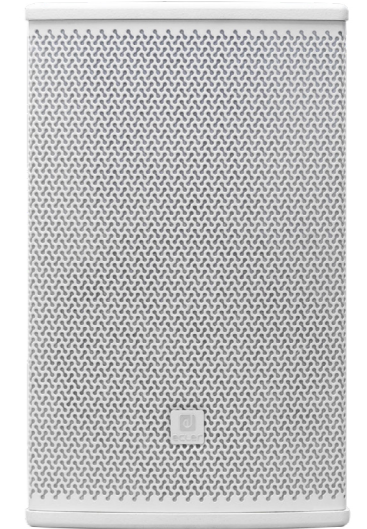

ARQIS108i

EASE

## ACCESSORIES

### ARQIS108i:



ARQ108UBWH



ARQ108UBBK

**ARQISi Series** has been specifically designed to fulfil permanent installation requirements where a perfect balance between sound performance and architectural / interior's design matching is a must. Evolution of the acclaimed ARQIS series, the ARQISi loudspeakers are fine-tuned to balance the sound across the entire range.

## KEY FEATURES

### ARQIS105i / ARQIS106i / ARQIS108i:

- Full range, 2-way architectural loudspeaker
- Double INPUT/STACK connector, Euroblock (+ Speakon®: ARQIS108i) type, with security attachment screws to avoid accidental disconnection
- VEASY Wall bracket included, allowing for pan & tilt adjustment, employing a single screw for fastening. Robust,
- quick and easy to install, including jumps and markings to adjust and repeat speakers orientation
- U-bracket wall-mount accessory compatible, ARQ108UB (not included) (ARQIS108i)
- Metal safety sling included, to avoid drops in case of accidental detachment from the wall surface
- Available in black (RAL 9005) or white (RAL 9003) finish

	ARQIS105i	ARQIS106i	ARQIS108i
RMS power / Peak power (8Ω)	70W / 280W	120W / 480W	150W / 600W
Woofer / tweeter	5,25" / 1" (tweeter)	6,5" / 1"	8" / 1"
Connector	Euroblock	Euroblock	Euroblock + Speakon
SPL 1W/1m	89 dB	88 dB	90 dB
Dimensions (WxHxD)	186x280x210mm / 7.32"x 11.02"x8.26"	216x350x240mm / 8.54" x 13.78" x 9.45"	244 x 390 x 280 mm / 9.61" x 15.35" x 11.02"
Weight	3,6 kg / 7.93 lb	7,4 kg / 16.31 lb	8,4 kg / 18.52 lb

## APPLICATIONS



Loudspeakers





# ARQISi Series

Loudspeakers



ARQIS205i / 208i  
Connection plate

ARQIS205i  
With U bracket (included in ARQIS205i / 208i)



ARQIS208i

## KEY FEATURES

### ARQIS205i / ARQIS208i:

- Full range, 2-way architectural loudspeaker
- Double INPUT/STACK connector, Euroblock + Speakon® type, with security attachment screws to avoid accidental disconnection
- "U" Shape wall bracket included, allowing for tilt adjustment
- 8 x M8 cabinet flying points.
- Metal safety sling included, to avoid drops in case of accidental detachment from the wall surface
- Available in black (RAL 9005) or white (RAL 9003) finish

	ARQIS205i	ARQIS208i
RMS power / Peak power (8Ω)	140W / 560W	300W / 1200W
Woofer / driver	2x5,25" / 1"	2x8" / 1"
Connector	Euroblock + Speakon	Euroblock + Speakon
SPL 1W/1m	90 dB	94 dB
Dimensions (WxHxD)	480x186x210mm / 18.90"x7.32"x8.27"	610x244x280mm / 24.01"x9.61"x11.02"
Weight	8,4 kg / 18.52 lb	14,4 kg / 31.74 lb



ARQIS110i



ARQIS112i



ARQIS110i / 112i Connection plate

## ACCESSORIES



SR12

### ARQIS110i:



ARQ110UBWH



ARQ110UBBK

### ARQIS112i:



ARQ112UBWH



ARQ112UBBK

## KEY FEATURES

### ARQIS110i / ARQIS112i:

- Full range, 2-way architectural loudspeaker
- Double INPUT/STACK connector, Euroblock + Speakon® type, with security attachment screws to avoid accidental disconnection
- U-bracket wall-mount accessory compatible, ARQ110UB/ARQ112UB (not included)
- 35 mm mount socket, compatible with SR12 wall bracket (not included)
- 8 x M8 cabinet flying points.
- Metal safety sling included, to avoid drops in case of accidental detachment from the wall surface
- Available in black (RAL 9005) or white (RAL 9003) finish

	ARQIS110i	ARQIS112i
RMS power / Peak power (8Ω)	300W / 1200W	500W / 2000W
Woofer / driver	10" / 1"	12" / 1,4"
Connector	Euroblock + Speakon	Euroblock + Speakon
SPL 1W/1m	94 dB	96 dB
Dimensions (WxHxD)	342.5 x 495 x 345 mm / 13.48" x 19.49" x 13.58"	565 x 403 x 380 mm / 22.24" x 15.87" x 14.96"
Weight	18,5 kg / 40.78 lb	23,8 kg / 52.47 lb

Loudspeakers





# LABI1 Series

Compact PA Systems



## ACCESSORIES



LABI1-SWK



LABI1-SPC



LABI1-CFC

Ecler **LABI1 Series** has been specially designed to provide a compact loudspeakers system solution for mobile and fixed installations in environments in need of high output, easy and quick installation, and excellent sound quality. The variety of products and accessories allows several different configurations, depending on the needs required.

## KEY FEATURES

### LABI1-SB18:

- 18" passive subwoofer with a compact design
- Frequency range (-10dB): 38Hz – 250Hz

### LABI1-SB18p:

- 18" powered subwoofer with a compact design
- 2400W built-in Class D amplification power
- Low frequency amplifier: 1200W
- Speaker output amplifier: 2x600W@4Ω
- 18 factory presets
- User control interface with LCD

### LABI1-C100i:

- Full-range passive 100cm loudspeaker column
- Twelve 3" drivers with 0.75" neodymium voice coil
- 300W AES
- Speakon® and 2-pin Euroblock input connectors (+LINK connectors)
- Several mounting options
- Ready for outdoor applications
- Black finish available (RAL 9005)

	LABI1-SB18	LABI1-SB18P	LABI1-C100i
RMS power / Program power	500W / 1200W	2400W Class D built in amp	300W / 600W
Speaker type	18" subwoofer with 3" voice coil	18" subwoofer with 3" voice coil	12x3" speaker with 0.75" voice coil
Inputs / Outputs	Speakon® / Speakon®	XLR / XLR + Speakon® (powered output)	Speakon® and 2-pin Euroblock input connectors (+LINK connectors)
Max SPL @ 1m	131 dB	131 dB	127 dB
Dimensions (WxHxD)	513 x 513 x 704 mm / 20.2" x 20.2" x 27.7"	514 x 513 x 704 mm / 20.2" x 20.2" x 27.7"	89 x 1000 x 117mm / 3.5" x 39.4" x 4.6"
Weight	37.1 kg / 81.8 lb	39.1 kg / 86.2 lb	7.8 kg / 17.2 lb

## APPLICATIONS



## ACCESSORIES



LABI1-SAC



LABI1-CAC



LABI1-TBC



LABI1-WBC



LABI1-PBC



LABI1-HBC



LABI1-ODCNX



1 x LABI1-C100i + LABI1-SB18p  
Mono-single column configuration



2 x LABI1-C100i + LABI1-SB18p  
Stereo-single column configuration

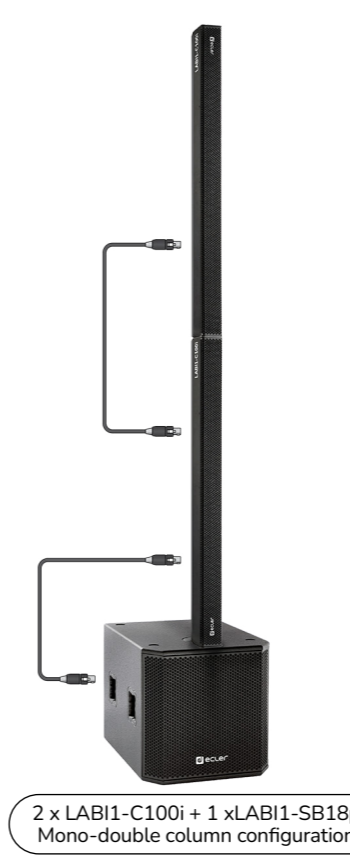

2 x LABI1-C100i + 1 x LABI1-SB18p  
Mono-double column configuration



4 x LABI1-C100i + 1 x LABI1-SB18p  
Stereo-double column configuration

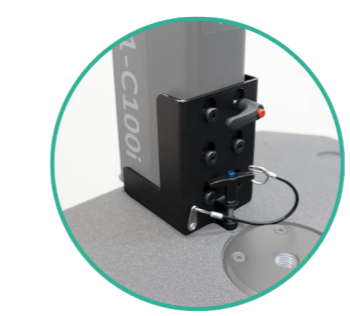

LABI1-SAC  
Subwoofer to column adapter



LABI1-CAC  
Column to column adapter



# TRAIL103

Rail-mount Cabinet

Loudspeakers



TRAIL 103 Loudspeakers mounted on ceiling light rail

TRAIL103

TRAIL 103 Mounting options (included): ceiling light rails, surface mount and truss/threaded bar adapter

EASE

TRAIL103 is a 3" lamp style loudspeaker cabinet.

### KEY FEATURES

- 3" woofer
- Mounting options: ceiling light rails (Global Trac Pro and Eutrac compatible), surface mount or truss mount
- Low impedance connection: 4Ω
- High impedance connection: 15/30W selector
- Available in white (RAL9003) and black (RAL9005) finish
- EASE Win file available

	TRAIL103
RMS power / Peak power (8Ω)	15W / 60W
Woofer / tweeter	3" / -
Power selector @ 100V	15/30 W
SPL 1W/1m	83 dB
Dimensions (WxHxD)	øxH: 96x110mm / 3.78"x4.33"
Weight	1,0 kg / 2.20 lb

### APPLICATIONS



# TRAILSB6T

Concealable Subwoofer Cabinet

Loudspeakers



TRAILSB6T front

TRAILSB6T rear

TRAILSB6T bottom

TRAILSB6T with installation accessories (included)

TRAILSB6T is a wooden subwoofer reinforcement cabinet with a very compact format. It has been specifically designed to fulfil permanent installation requirements, where low visual impact and integration with decoration are a must: concealed in false ceilings or partition walls, on walls' surface, etc. Installation accessories included.

### KEY FEATURES

- Wooden subwoofer reinforcement for TRAIL103-type cabinets, in-ceiling loudspeakers or small surface-mount cabinets
- Concealed in false ceilings or partition walls, on walls' surface, etc.
- Coupling pipe for false ceiling included
- Installation accessories included
- Available in black finish

	TRAILSB6T
RMS power / Peak power (8Ω)	60W / 240W
Woofer / tweeter	6" / -
Power selector @ 100V	7,5/15/30/60 W
SPL 1W/1m	86 dB
Dimensions (WxHxD)	200x200x320mm / 7.87"x7.87"x12.60"
Weight	6,3 kg / 13.89 lb

### APPLICATIONS





# AMBIT Series

Surface Mount Cabinets

Loudspeakers



AMBIT-13

AMBIT-16

AMBIT-18



## ACCESSORIES

### eMOTUS5PB:



WPa Series

**AMBIT-13 / AMBIT16 / AMBIT-18** is an ultra compact 2-way coaxial loudspeaker cabinet with neutral and discreet design.

### KEY FEATURES

- ABS 2-way architectural loudspeaker
- Built-in audio transformer for 100V applications
- 8Ω and 70/100V operation selector
- Includes on-wall hardware, safety sling, screws and wrench for fast installation
- Available in black (RAL9005) and white (RAL9016) colours
- Spring loaded input terminals
- IP54 rated
- Anti UV cabinet avoids colour degradation in case of direct sunlight exposition

	AMBIT-13	AMBIT-16	AMBIT-18
RMS power / Peak power (8Ω)	25W / 100W	50W / 200W	70W / 280W
Woofer / tweeter	3,5" / 0,5"	6,5" / 1"	8" / 1,18"
Power selector @ 100V	2,5/5/7,5/15 W	5/7,5/15/30 W	60 W @ 100V / 30 W @ 70V
SPL 1W/1m	87 dB	93 dB	93 dB
Dimensions (WxHxD)	120x120x117mm / 4.72"x4.72"x4.60"	210x210x160mm / 8.27"x8.27"x6.30"	258x258x225mm / 10.15"x10.15"x8.85"
Weight	1,3 kg / 2.86 lb	2,8 kg / 6.17 lb	5,6 kg / 12.34 lb

### APPLICATIONS



# AUDEO Series

Surface Mount Cabinets

Loudspeakers



AUDEO103

AUDEO106



AUDEO Cabinets Wall brackets (included)



AUDEO106



**AUDEO Series** has a balanced, innovative design, resulting from the collaboration between ECLER and the prestigious group Giugiaro Design. It satisfies today's demands with respect to aesthetics, design and integration into all types of architectural environments which, together with its excellent sound quality, make this series the ideal solution for use in numerous sound projects.

### KEY FEATURES

#### AUDEO103 / AUDEO106:

- Full range, 2-way loudspeaker
- Made of reinforced ABS
- Available in black (RAL9005) or white (RAL9016)
- 8Ω and 70/100 V line operating switch
- Accessories for wall-mounting included
- IP54 class outdoor rating
- Protective front grill with anti-rust treatment
- EASE Win file available

	AUDEO103	AUDEO106
RMS power / Peak power (8Ω)	25W / 100W	50W / 200W
Woofer / tweeter	3,5" / 0,5"	6,5" / 1"
Power selector @ 100V	2,5/5/7,5/15 W	5/7,5/15/30 W
SPL 1W/1m	86 dB	90 dB
Dimensions (WxHxD)	132x134x110mm / 5.29"x5.27"x4.33"	242x242x163mm / 9.52"x9.52"x6.41"
Weight	1,5 kg / 3.30 lb	2,3 kg / 5.07 lb

### APPLICATIONS





# eMOTUS Series

Surface Mount Cabinets



eMOTUS5PB Slave Unit

eMOTUS5PB Remote Controller

eMOTUS5PB Master Unit



eMOTUS Wall Mount (included)



eMOTUS5P Front



eMOTUS5P Slave Unit rear



eMOTUS5P Master Unit rear

## ACCESSORIES eMOTUS5PB:



WPa Series

The eMOTUS5P / eMOTUS5PB is a kit of loudspeakers including an active and a passive acoustic box. The eMOTUS5PB includes a wireless BT receiver, remote control and remote control volume port (0-10 VDC). Available in white colour (RAL9003).

### KEY FEATURES

#### eMOTUS5P / eMOTUS5PB:

- Stereo 2-way loudspeaker stereo kit – powered loudspeaker + passive loudspeaker
- Full range: 5" woofer and 1" tweeter
- Integrated amplifier 2 x 25 WRMS (MASTER unit)
- Volume control and tone control (bass & treble) in the MASTER unit
- Euroblock balance stereo input on the MASTER UNIT
- Non-balanced RCA input on the MASTER UNIT
- Wireless BT stereo input (only on the eMOTUS5PB)
- Mono/Stereo switch
- Link between the MASTER and the SLAVE unit via Euroblock connectors.
- Integrated power supply source (MASTER unit)
- Selectable power voltage 115 V/230 V (MASTER unit)
- Auto standby function (automatic standby mode / energy saving without the need to turn the system on or off each day)
- Integrated Anti-Clip System
- LED activity display
- Reinforced ABS construction
- BT wireless connection, remote control port (0-10 VDC – RJ45 connector) and remote control (eMOTUS5PB)

	eMOTUS5P	eMOTUS5PB
RMS power / Peak power (8Ω)	2 x 25W / 2 x 100W	2 x 25W / 2 x 160W
Audio inputs	2 ST LINE (bal. & unbal.)	2 ST LINE (bal. & unbal.) + BT
Others	Bass & treble EQ + ST/MONO switch	IR + Remote port + Bass & treble EQ + ST/MONO switch
Dimensions (WxHxD)	173x180x185mm / 6.81"x 7.08"x7,28"	173x180x185mm / 6.81"x 7.08"x7,28"
Weight	2,1 kg / 4.62 lb	2,4 kg / 5.29 lb

### APPLICATIONS



eMOTUS30D & eMOTUS50D & eMOTUS80D



eMOTUS80D side



eMOTUS80D



## ACCESSORIES eMOTUS30D/50D:



GROUNDY



CEILY

## eMOTUS50D:



RAILAPTOR

eMOTUS30D / eMOTUS50D / eMOTUS80D is a full range loudspeaker cabinet with eMOTUS unique design. Ready for indoor and outdoor applications, thanks to its aluminium grill and UV protection treatment (IP65-rated). Wall mount accessories and safety sling are included for an easy and secure installation.

### KEY FEATURES

#### eMOTUS30D / eMOTUS50D / eMOTUS80D:

- Speaker for wall installation (ceiling or floor installation with compatible accessories)
- Outdoor design
- IP65 rated
- Back rubber cover for connections
- Available in black (RAL9005) and white (RAL9003) colour

	eMOTUS30D	eMOTUS50D	eMOTUS80D
RMS power / Peak power (8Ω)	25W / 100W	40W / 160W	100W / 400W
Power selector @ 100V	15/7,5/5/2,5 W	7,5/15/30 W	60/30/15/7,5/3,5 W
Others	IP65	IP65	IP65
Dimensions (WxHxD)	132x134,5x117,4mm / 5.29"x5.27"x4.62"	173x180x181mm / 6.81"x 7.08"x7.12"	264 x 269 x 242 mm / 10.4" x 10.6" x 9.5"
Weight	1,18 kg / 3.30 lb	2,4 kg / 5.29 lb	4,25kg / 9.37 lb





# MIA Series

Mini Array Column Loudspeakers



Loudspeakers



## ACCESSORIES

### MIA-81/MIA-82

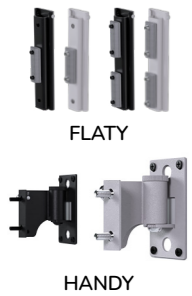

MIA Series of column loudspeakers incorporates an elegant, unique and compact design built in a single aluminium piece to reduce components vibrations. The two columns behave as a mini line array with the disposition of 8 drivers per column and the possibility of working in 16Ω or 64Ω impedance by selecting them behind the logo located in the grill.

### KEY FEATURES

- Column passive loudspeaker for surface mounting
- 64Ω or 16Ω impedance, selectable via the switch behind the logo
- MIA-82 allows the connection of high impedance amplifiers by selecting 64Ω
- Aluminium one-piece non resonant compact enclosure
- Available in black and white colours
- Stack Output
- FLATY bracket allows the column to be mounted against the wall. (MIA-81)
- HANDY wall-mount versatile pan and tilt bracket included. (MIA-82)
- Weather-protected with IP44 rating



	MIA-81	MIA-82
RMS power / Peak power	40 W RMS / 160 W Peak	150 W RMS / 600 W Peak
Woofer / tweeter	8 x 1,5" driver	8 x 2,5" driver
Nominal Impedance	16Ω / 64Ω	16Ω / 64Ω
Dimensions (WxHxD)	58 x 67 x 448 mm / 2.28 x 2.63 x 17.63 in	83 x 648 x 87 mm / 3.26 x 25.50 x 3.42 in
Weight	1.9 kg / 4.18 lb	2.65 kg / 5.84 lb

### APPLICATIONS



# eCMP8 / 12

Musical projectors

Loudspeakers

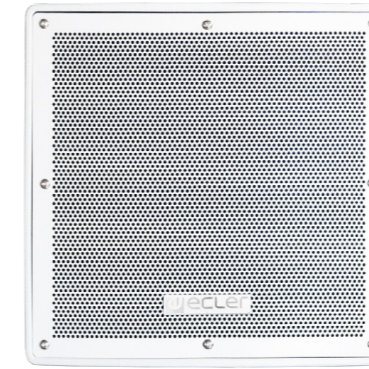

eCMP8

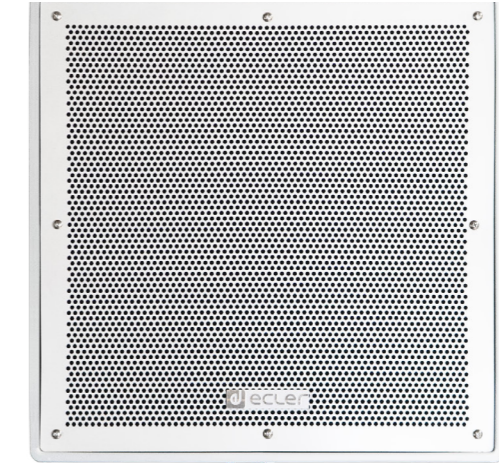

eCMP12



eCMP8 U-bracket (included)



eCMP8



Ecler eCMP8 / eCMP12 are high efficiency musical projectors ready for outdoor applications due to its waterproof and sun screening building material (IP56). Grey finished color (RAL 538C). Suitable for high and low impedance. U-bracket included.

### KEY FEATURES

#### eCMP8:

- Weatherproof 2-way music projector
- 150 W @ 8Ω
- Input & output connection via terminal block
- Dispersion (HxV): 100° x 100°
- Material: Polypropylene, aluminium (grille), hot-dipped galvanized steel (U-bracket)

#### eCMP12:

- Weatherproof 2-way music projector
- 300 W @ 8Ω
- Input & output connection via terminal block
- Dispersion (HxV): 80° x 80°
- Material: Polypropylene, aluminium (grille), hot-dipped galvanized steel (U-bracket)

	eCMP8	eCMP12
RMS power / Peak power (8Ω)	150W / 600W	300W / 1200W
Power selector	37,5/75/150W @ 100V 18,75/37,5/75W @ 70V	50/100/200W @ 100V 25/50/100W @ 70V
Others	IP56	IP56
SPL 1W/1m	96 dB	98 dB
Dimensions (WxHxD)	300 x 302 x 334mm / 11.8" x 11.9" x 13.2"	407 x 410 x 378mm / 16.0" x 16.1" x 14.9"
Weight	11,0 kg / 24.3 lb	20,0 kg / 44.1 lb

### APPLICATIONS





# MIA

MIA is a an elegant, unique a compact design column loudspeaker, built in a single aluminium piece to avoid vibrations and mechanical stress



MIA-81

8x1,5" | 40WRMS

MIA-82

8x2,5" | 150WRMS



# IG108 / eRK108

In-ground Cabinets



IG108 waterproof connector (IP65 rated)

IG108 with security ground bracket

eRK108

IG108 security ground bracket (included)



## KEY FEATURES

### IG108:

- IP65 outdoor rated loudspeaker
- 8Ω and 70/100 V (7,5, 15, 30 or 60 W tap switch)
- 8" Kevlar woofer and 1" ACCW silk dome tweeter
- Frequency response (-10 dB): 50 Hz to 23 kHz
- Omni directional horizontal coverage pattern (a circular area with an average radius of 4 to 6 meters can be covered by one unit, in a standard application)
- Security ground bracket included
- EASE Win file available

### eRK108:

- IP65 outdoor rated loudspeaker
- 70/100 V (15 W)
- 8" woofer + 0,5" tweeter
- Stripped wire connection
- EASE Win file available

	IG108	eRK108
RMS power / Peak power (8Ω)	100W / 400W	-
Woofer / tweeter	8" / 1"	8" / -
Power selector @ 100V	7,5/15/30/60 W	15 W
SPL 1W/1m	92 dB	89 dB
Dimensions (WxHxD)	øxH: 360x392,5mm / 14.17"x15.45"	325x290x270mm / 12.79"x11.41"x10.63"
Weight	8,5 kg / 18.74 lb	5,0 kg / 11.02 lb

## APPLICATIONS





# eIC Series

In-Ceiling/In-Wall Loudspeakers



Loudspeakers



**eIC51FM / eIC52 / eIC52MS** is a cost-effective in-ceiling installation loudspeaker with a great sound performance.

### KEY FEATURES

- Built-in audio transformer for 70/100 V use
- Suitable for installations exposed to extreme humidity and/or temperature (eIC52MS)
- EASE Win file available



	eIC51FM	eIC52	eIC52MS
RMS power / Peak power (8Ω)	6 W	20W / 80W	20 / 80W
Woofer / tweeter	4,5" / -	5,25" / 0,75"	5" / 1"
Power selector	3/6 W @ 100V   1,5/3W @ 70V	3/6 W @ 100V	-
SPL 1W/1m	91 dB	89 dB	91 dB
Dimensions (ø internal x ø external x D)	145x160x54mm / 5.7"x6.3"x2.1"	164x202x65mm / 6.45"x7.95"x2.56"	120x165x60mm / 4.72"x6.49"x2.36"
Weight	0,5 kg. / 1.1 lb	1,0 kg / 2.20 lb	0,6 kg / 1.32 lb

### APPLICATIONS



# IC Series / IW103

In-Ceiling/In-Wall Loudspeakers



Loudspeakers



### ACCESSORIES

#### IC Series:



PKIC Series

**IC3 / IC6 / IC8** in ceiling/in wall loudspeaker is the perfect option for 70/100 V and low impedance sound solutions. IC series provide excellent sound quality thanks to their infinite baffle philosophy and a top-performance high frequency transducer.

**IW103** in-ceiling / in-wall installation loudspeaker featuring a rectangular and discreet design.

### KEY FEATURES

#### IC Series:

- ABS speaker
- Built-in audio transformer for 70/100 V use
- Polypropylene woofer that resists heat and humidity
- Front grill may be removed for painting
- Aluminium front grill, rust-proof

#### IW103:

- Rectangular shaped loudspeaker for in-ceiling/in-wall installation
- 3" woofer
- 15W/30W @ 100V selector
- Spring loaded input terminals



	IC3	IC6	IC8	IW103
RMS power / Peak power (8Ω)	10W / 40W	40W / 160W	60W / 240W	-
Woofer / tweeter	3" / -	6" / 1"	8" / 1"	3" / -
Power selector @ 100V	1,5/3/6 W	2,5/5/7,5/15 W	5/7,5/15/30 W	15/30 W
SPL 1W/1m	86dB	93 dB	94 dB	84 dB
Dimensions (ø internal x ø external x D)	82x100x95mm / 3.22"x3.93"x3.74"	178x204x73mm / 7"x8.03"x2.87"	220x245x91mm / 8.66"x9.64"x3.58"	(WxHxD) 110x165x80mm / 4.33"x6.49"x3.14"
Weight	520 g / 1.14 lb	1,5 kg / 3.30 lb	2,3 kg / 5.07 lb	900 g / 1.98 lb

### APPLICATIONS





# VIC Series

In-Ceiling/In-Wall Loudspeakers



Tile bridge and back can included in VIC 6X / 8X / SB8X



## ACCESSORIES



AVICSG

## VIC6/6X:



AVICAN6L



AVICRG6

## VIC8/SB8/8X/SB8X:



AVICAN8L



AVICRG8

Ecler's line of **VIC** ceiling loudspeakers features a careful selection of components in a user-friendly design that seeks speed and versatility of installation on any surface, while maintaining excellent sound quality.

The X models include a back can and tile bridge.

## KEY FEATURES

### VIC6/VIC6X:

- 2-way false ceiling loudspeaker
- 6,5" polypropylene woofer
- 0,5" steerable tweeter
- Output 40WRMS@8Ω

### VIC8/VIC8X:

- 2-way false ceiling loudspeaker
- 8" polypropylene woofer
- 0,5" steerable tweeter
- Output 60WRMS@8Ω

### VICSB8/VICSB8X:

- False Ceiling Subwoofer Unit
- 8" polypropylene woofer
- Output 80WRMS@8Ω
- Crossover included

	VIC6/6X	VIC8/8X	VICSB8/SB8X
RMS power / Peak power(8Ω)	40W / 160W	60W / 240W	80W / 320W
Woofer / tweeter	6,5" / 0,5"	8" / 0,5"	8" / -
Power selector @ 100V	40/20/10/5/2,5W	60/30/15/7.5/3.75W	60/30/15/7.5/3.75W
SPL 1W/1m	89 dB	90 dB	87 dB
Dimensions (øxD)	VIC6: 232x105mm / 9.1"x4.1" VIC6X: 232x170mm / 9.1"x6.7"	VIC8: 282x115mm / 11.1"x4.5" VIC8X: 282x200mm / 11.1"x7.9"	VICSB8: 282x135mm / 11.1"x5.3" VICSB8X: 282x200mm / 11.1"x7.9"
Weight	VIC6: 1.8kg / 3.9 lb VIC6X: 2.3kg / 5 lb	VIC8: 2.3kg / 5 lb VIC8X: 3.1kg / 6.8 lb	VICSB8: 3.2kg / 7 lb VICSB8X: 3.9kg / 8.6 lb

## APPLICATIONS



Loudspeakers



## Painting Loudspeakers



Paintable rust-proof grids (RAL standard)

The **PKIC series** is a simple solution for giving colour and homogeneity to ceiling loudspeakers in the IC or IC6CLASS series. These easy to install accessories make it possible to combine different loudspeaker models in the same ceiling or wall, offering a homogenous, elegant, colourful finish. You can paint them yourself or we can do it for you!

**PKIC6:** this is an accessory for personalizing the IC6 ceiling loudspeaker. The kit includes a grille that can be painted (with the appearance of the IC6CLASS) and an accessory (anchor ring) to mount this grille on the IC6. Easy to paint and mount.

**PKIC8:** this is an accessory to personalize the IC8 ceiling loudspeaker. The kit includes a grille that can be painted (with the appearance of the IC6CLASS) and an accessory (anchor ring) to mount this grill on the IC8.

**AVICSG:** square grille with magnetic mounting. Compatible with all VIC models.

**AVICRG6** is a 2 paintable aluminum round grilles kit, compatible with VIC6 and VIC6X loudspeakers. Magnetic fixing, quick installation. Available in black and white.

**AVICRG8** is a 2 paintable aluminum round grilles kit, compatible with the VIC8, VIC8X, VICSB8 and VICSB8X loudspeakers. Magnetic fixing, quick installation. Available in black and white.

Our painting service offers the possibility to paint any accessory in the PKIC and VIC series, without a minimum of loudspeakers and with delivery within 15 days.

Loudspeakers





# eCS803 / eUC106

Column / Spherical Cabinets



eCS803

eUC106

eCS803: eUC106:

## KEY FEATURES

### eCS803:

- Column type loudspeaker
- Transformer selector: low/high impedance
- Stripped wire connection
- Aluminium enclosure
- IP44 rated
- Included wall bracket
- Available in white (RAL9016)

### eUC106:

- Spherical pendant type loudspeaker
- 8Ω and 70/100 V (40W RMS)
- 6.5" woofer + 1" tweeter
- Transformer selector: 32W-16W-8W-4W 100V / 16W-8W-4W-2W 70V - 8Ω
- Stripped wire connection (3m)
- Available in white (RAL9003) and black (RAL9005) finish
- EASE Win file available

	eCS803	eUC106
RMS power / Peak power (8Ω)	80W / 320W	40W / 160W
Woofer / tweeter	8x3" / -	6,5" / 1"
Power selector @ 100V	5/10/20/30 W	4/8/16/32 W
SPL 1W/1m	95 dB	90 dB
Dimensions (WxHxD)	105x760x90mm / 4.13"x29.92"x3.54"	øxH: 270x215mm / 10.62"x 8.46"
Weight	4,5 kg / 9,92 lb	3,0 kg / 6.61 lb

## APPLICATIONS



Loudspeakers



# ePRS10Ti / ePRS20Ti / ePHS30Ti / eMSP50Ti

Public Address Cabinets



ePRS10Ti

ePRS20Ti

ePHS30Ti

eMSP50Ti

ePRS10Ti/ePRS20Ti: ePHS30Ti/eMSP50Ti:

Sound projectors carefully selected for the most extended 70V/100V paging and background music applications, offering durability and optimal speech and music reproduction.

## KEY FEATURES

- ABS weatherproof
- Suitable for outdoor applications
- Power tapings for 70V and 100V
- EASE Win file available
- ePRS10Ti / ePRS20Ti available in white (RAL9016)
- ePHS30Ti available in light gray (RAL7035)
- eMSP50Ti available in papyrus white (RAL9018)

	ePRS10Ti	ePRS20Ti	ePHS30Ti	eMSP50Ti
RMS power / Peak power (8Ω)	-	-	30W / 120W	50W / 200W
Power selector @ 70/100V	10/5/2,5W @ 100V 5/2,5/1,25W @ 70V	20W / 10W / 5W @ 100V 10/5/2,5W @ 70V	30/15/7,5/3,75W @ 100V 30/15/7,5/3,75 /1,9W @ 70V	50/25/12,5/9/4,5 /2,6W @ 100V 25/12,5/9/4,5/2,6 /1,3W @ 70V
IP Certified	IP55	IP55	IP66	IP66
SPL 1W/1m	90 dB	96 dB	104 dB	95 dB
Dimensions (WxHxD)	ØxH : Ø 138 x 205mm / Ø 5.4" x 8.1"	Ø 170 x 245mm / Ø 6.7" x 9.6"	Ø 246 x 292mm / Ø 9.7" x 11.5"	362 x 252 x 310mm / 14.3" x 9.9" x 12.2"
Weight	1.6 kg / 3.5 lb (including accessories)	1.8 kg / 4.0 lb (including accessories)	2.4 kg / 5.3 lb (including accessories)	3,9 kg. / 8.6 lb

## APPLICATIONS



Loudspeakers





# ARQISSB Series

Subwoofers



## KEY FEATURES

### ARQISSB6Ti:

- Euroblock connector and spring loaded input terminals
- LPF cut-off frequency selection: OFF/ 120Hz / 150Hz
- Wall-mount hardware included
- Available in black (RAL 9005) or white (RAL 9003) finish

### ARQISSB10i:

- Euroblock connector and spring loaded input terminals
- LPF cut-off frequency selection: OFF/ 120Hz / 150Hz
- Wall-mount hardware included
- 12 x M8 cabinet flying points
- Available in black (RAL 9005) or white (RAL 9003) finish

### ARQISSB12i:

- Double INPUT/STACK connector, Speakon® type
- 12 x M8 cabinet flying points.
- Available in black (RAL9005) finish

### ARQISSB15i:

- Double INPUT/STACK connector, Speakon® type
- 35 mm top-hat mount socket, for pole mount combinations with ARQIS110i, ARQIS112i, etc.
- 8 x M8 cabinet flying points.
- Available in black (RAL9005) finish

	ARQISSB6Ti	ARQISSB10i	ARQISSB12i	ARQISSB15i
RMS power / Peak power (8Ω)	60/120W @ 70/100V ; 120W @ 8Ω	150W / 600W	300W / 1200W	600W / 1200W
Woofers	6,5" + 6,5" passive radiator	10"	12"	15"
Connector	Euroblock + spring loaded terminals	Euroblock + spring loaded terminals	Speakon	Speakon
SPL 1W/1m	86 dB	92 dB	95 dB	97 dB
Dimensions (WxHxD)	390 x 250 x 130 mm / 15.35" x 9.84" x 5.12"	600x442x228mm / 23.62"x17.40"x8.98"	440 x 375 x 440 mm / 17.32" x 14.76" x 17.32"	460 x 534 x 525 mm / 18.11" x 21.02" x 20.67"
Weight	8,2 kg / 18.07 lb	16,5 kg / 36.37 lb	23 kg / 50.70 lb	32,0 kg / 70.54 lb

# EDGE-SB110P

Subwoofers



Rounded bass sound in a compact size, EDGE 10" powered subwoofer is perfectly designed for small available spaces like underneath restaurant seats or wall-mounted in a corner with the included bracket.

## KEY FEATURES

- Ultra compact
- 10" driver
- 150 W amplified power output
- 50Hz to 150Hz variable low pass filter
- Phase inverter
- Available in black color.
- Several installation options (flat tabletop, underneath seats, vertical, wall-mounted...)

	EDGE-SB110P
Woofers / tweeter	10"
Amplifier Power Output (Powered)	150W @ THD < 0.5%
Variable LPF	50Hz - 150Hz
Dimensions (WxHxD)	635 x 400 x 178 mm / 23,62 x 15,74 x 7 in
Weight	TBC

## APPLICATIONS



Loudspeakers



Loudspeakers



EASE

EASE



# KICK-SB28

Subwoofers

Loudspeakers



KICK-SB28



As the first Ecler outdoor subwoofer, the new **KICK-SB28** features 2x8" woofers perfectly positioned to maximize the low frequency response while reducing the vibrations on the acoustic enclosure.

## KEY FEATURES

- 700W RMS @ 4Ω outdoor passive subwoofer
- 2x8" woofers
- Vibration free
- Outdoors
- Weather-protected with IP44 rating
- Rubber feet for floor installation, either vertical or horizontal included
- Bracket included for wall-mounted

	KICK-SB28
RMS power / Peak power	700 W RMS / 2800 W Peak
Woofer / tweeter	2x8"
Nominal Impedance	4Ω
Dimensions (WxHxD)	660x450x250 mm / 25,98"x17,71"x9,84"
Weight	23 Kg / 50.70lb

## APPLICATIONS



# NIMBO

Top performance cabinet loudspeaker

NIMBO-14

1X4" | 2 WAY | 40WRMS

NIMBO-24

2X4" | 2 WAY | 80WRMS

NIMBO-26

2X6" | 2 WAY | 140WRMS





# MPAGE1r / MPAGE4 / eMPAGE

Paging Stations

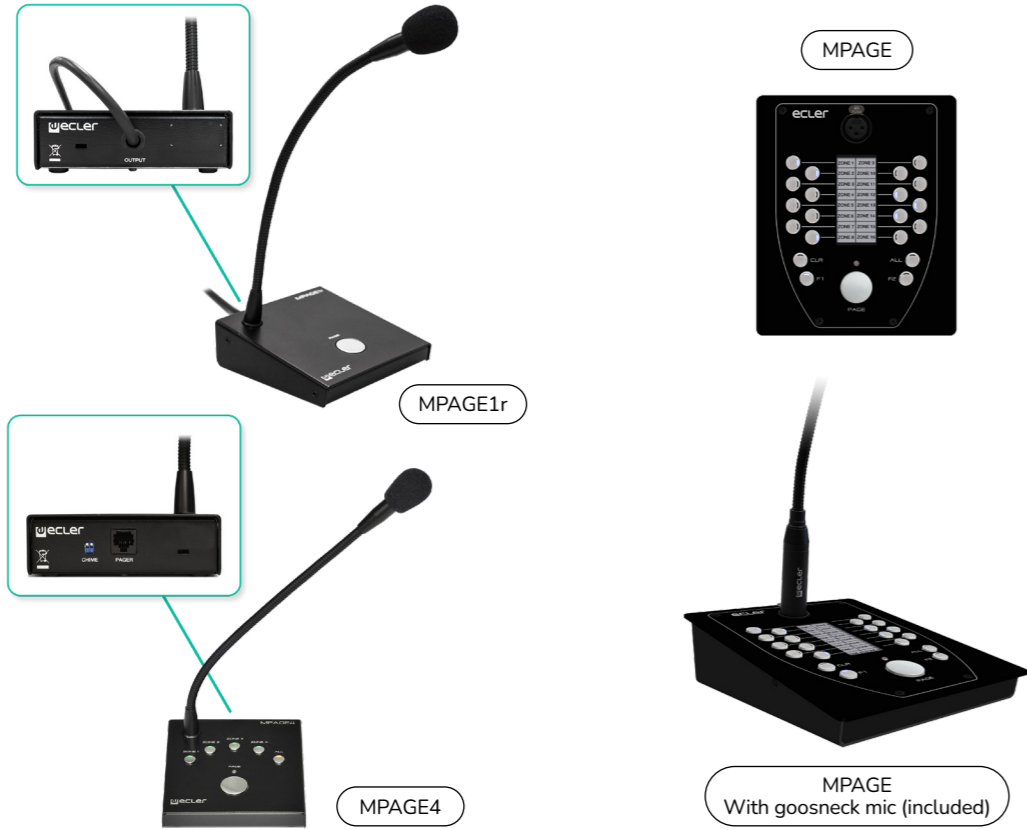

**MPAGE1r** is a 1-zone desktop paging station, compatible with any device including a phantom-powered microphone input (SAM series, COMPACT series, DAM614, MIMO88, CA series, HMA series, etc.).

**MPAGE4** is a 4-zone desktop paging station compatible with DAM614, CA series, etc. It allows for real-time paging with zones' destination selection.

**eMPAGE** is a digital paging station (MPAGE16's evolution), compatible with HUB, MIMO88, MIMO88SG and MIMO1212SG digital matrixes. Includes: a gooseneck cardioid microphone (removable); 16 zone-selection keys; ALL, CLEAR and PAGE keys; 2 programmable keys, F1 & F2, for zone-group selection. Text labelling for destination areas by means of programmable electronic ink display.

	MPAGE1r	MPAGE4	eMPAGE
Paging zones	1	4	16
Additional keys	-	ALL	ALL + CLEAR + F1 + F2
Phantom Power	10 - 48VDC	6 - 15VDC	48VDC, always ON
Connector	Euroblock	RJ45	RJ45 (internal)
Dimensions (WxHxD) (mic excluded)	120x43x126mm / 4.72"x1.69"x4.96"	120x43x126mm / 4.72"x1.69"x4.96"	150x50x180mm / 5.90"x1.96"x7.08"
Weight (mic excluded)	625 g / 1.37 lb	626 g / 1.37 lb	900 g / 1.98 lb

## APPLICATIONS



Remote Controls & Interfaces



# PAGENETDN

EclerNet Dante Paging Station



**PAGENETDN** is a desktop paging console for voice notices with Dante™ audio over IP which works perfectly to manage huge zoning projects in combination with MIMO7272DN matrixes.

## KEY FEATURES

- Desktop paging station based on touch screen and programmable UCP panels
- Flexo type microphone included
- Audio transport using Dante™
- EclerNet control device, with the ability to execute EclerNet projects on its internal engine, acting as a server and / or client of UCP panels
- 10" capacitive touch screen
- PoE power or by local power supply
- Ethernet communication interface
- Analog audio output (MIMO88 / 88SG / 1212SG compatible)

	PAGENETDN
Display	10.1" IPS Capacitive multitouch
Resolution	1280 x 800 Pixels
Connection port	Ethernet Base-Tx 10/100Mb / 1GB CAT5e or better up to 100m. PoE enabled
Dante Network TX channels	2 (integrated MIC + external AUX input)
Dimensions (WxHxD) (mic excluded)	295x155x135 mm / 11.6"x6.1"x5.3"
Weight (mic excluded)	1.5 kg / 3.3 lbs

## APPLICATIONS



Remote Controls & Interfaces





# WPNETTOUCH

TFT Touchscreen EclerNet Control



WPNETTOUCH



WPNETTOUCH

VESA 75 mounting system (included)

**WPNETTOUCH** is a remote control TFT touchscreen compatible with all EclerNet products. Incorporates a capacitive 10" touch screen, a server client and UCP server (User Control Panel). Each unit could be configured to work as a single zone control panel or as a global multi-zone controller. It allows executing User Control Panels that are able to control volume, sound source selection, presets recovery, communication via TCP/UDP with external devices, etc.

### KEY FEATURES

- EclerNet control device, with the ability to execute EclerNet projects on its internal engine, acting as a server and / or client of UCP panels
- 10" capacitive touch screen
- PoE power or local power supply
- Ethernet communication interface
- VESA75 and desktop mounting systems included

	WPNETTOUCH
Display	10.1" IPS Capacitive multitouch
Resolution	1280 x 800 Pixels
Connection port	Ethernet Base-Tx 10/100Mb / 1GB CAT5e or better up to 100m. PoE enabled
Power Supply	12V (local PSU)
Dimensions (WxHxD)	260x178x28mm / 10.23"x7"x1.10"
Weight	700gr / 1.54 lb

### APPLICATIONS



Remote Controls & Interfaces



# PULSO Series

Digital Control & Panels



PULSO-6

Ecler next generation of digital remote wall panels with an elegant minimalistic design. Featuring aluminum frame and capacitive TFT display, the new PULSO wall panels are the perfect choice to load the User Control Panels of VIDA Series, EclerNet, and other present and future Ecler developments. They are compatible with the standard UCP panels architecture, and also with third-party UCP clients (iOS®, Android®, Windows®, etc.) and with standard European electrical boxes and can manage PoE or external supply for an easier and practical installation.

### KEY FEATURES

- Capacitive touch screen in 4", 5.5" and 10"
- Elegant aluminum frame
- Standard EU 1-unit electric wall box compatible
- UCP client and server for EclerNet
- Compatible with EclerNet and VIDA

	PULSO-4	PULSO-6	PULSO-10
Screen Dimension and resolution	4" Capacitive TFT 480x480	5.5" Capacitive TFT 720x1280	10" Capacitive TFT 1280x1800
Construction	Aluminium frame with Ecler laser printed logo (compatible with Standard EU 1-unit electric wall box)		
DC power supply	POE and external VDC power supply		
Dimensions (WxHxD)	89x89x36mm / 3,50"x3,50"x1,42"	84x146x36 mm / 3,30"x5,75"x1,42"	259x177x37mm / 10,20"x6,97"x1,45"
Weight	TBC	TBC	TBC

### APPLICATIONS



Remote Controls & Interfaces





# WP22DN

AES67 / Dante™ Wall Interface



WP22DN

**WP22DN** is a Dante™ interface in a wall panel format. It features 2 audio MIC/LINE Combo connector inputs in its frontal panel and 2 Dante™ conversion channels either directly or by the sum of channels (stereo to mono conversion). Also, it features 2 analogue outputs with duplicated connectors in XLR format for the front panel and Euroblock on the rear panel, both linked to 2 Dante™ channels coming from the local network.

### KEY FEATURES

- Dante™ interface wall panel
- Ecler Double gang surface mount box included
- PoE power or by local power supply

	WP22DN
Inputs	2 analog, balanced, MIC/LINE level
Outputs	2 analog, balanced, line level
Connectors	Dante 2x2 interface, RJ45, PoE ready Audio In: 2x Combo / Audio Out: 2x XLR M (external) 2x Euroblock (internal)
Phantom Power	+48VDC, 5mA max.
Dimensions (WxHxD)	170x85x40mm / 3.38"x3.38"x1.57"
Weight	400gr / 0.88 lb

### APPLICATIONS



# WPNET4KV / 8K

EclerNet Wall Panel



WPNET4KV



WPNET4KV



WPNET8K



WPNET12KV



WPNET4KVUS (with USA frame)



WPNET8KUS (with USA frame)

**WPNET4KV** is an EclerNet compatible wall panel. It features a LCD screen, encoder and 4 selection keys. Works perfectly to enable volume control, source and preset selection functions.

**WPNET8K** is an EclerNet compatible wall panel. It features a LCD screen and 8 selection keys. Works perfectly to enable presets or source selection functions.

**Note:** in some cases is possible to combine a pair of WPNET4KV+WPNET8K to make them work together as a 12 selection key and a digital volume controller ("WPNET12KV"). This combination is compatible for instance, with MIMO7272DN matrix. For more information consult our tech support service.

### KEY FEATURES

- Remote control panel of MIMO4040CDN/MIMO7272DN devices
- Compatible with NXA / MIMO88 / 88SG / 1212SG through dedicated firmware.
- PoE power or by local power supply
- Ethernet communication interface
- Compatible with wall installation boxes with round shape and internal diameter ≥ 60 mm.
- Surface mount box included

	WPNET4KV	WPNET8K	WPNET4KVUS	WPNET4KVUS
Display	LCD	LCD	LCD	LCD
Resolution	128x128 Pixels	128x128 Pixels	128x128 Pixels	128x128 Pixels
Connection port	Ethernet interface, RJ45, PoE enabled	Ethernet interface, RJ45, PoE enabled	Ethernet interface, RJ45, PoE enabled	Ethernet interface, RJ45, PoE enabled
Control keys	Encoder, 4 SELECTION keys	8 SELECTION keys	Encoder, 4 SELECTION keys	9 SELECTION keys
Dimensions (WxHxD)	170x85x40mm / 3.38"x3.38"x1.57"	170x85x40mm / 3.38"x3.38"x1.57"	116,5x115x26mm / 4.59"x4.52"x1.02"	116,5x115x26mm / 4.59"x4.52"x1.02"
Weight	120 gr / 0.26 lb	120 gr / 0.26 lb	120 gr / 0.26 lb	120 gr / 0.26 lb

### APPLICATIONS





# eMCONTROL1

Remote Control

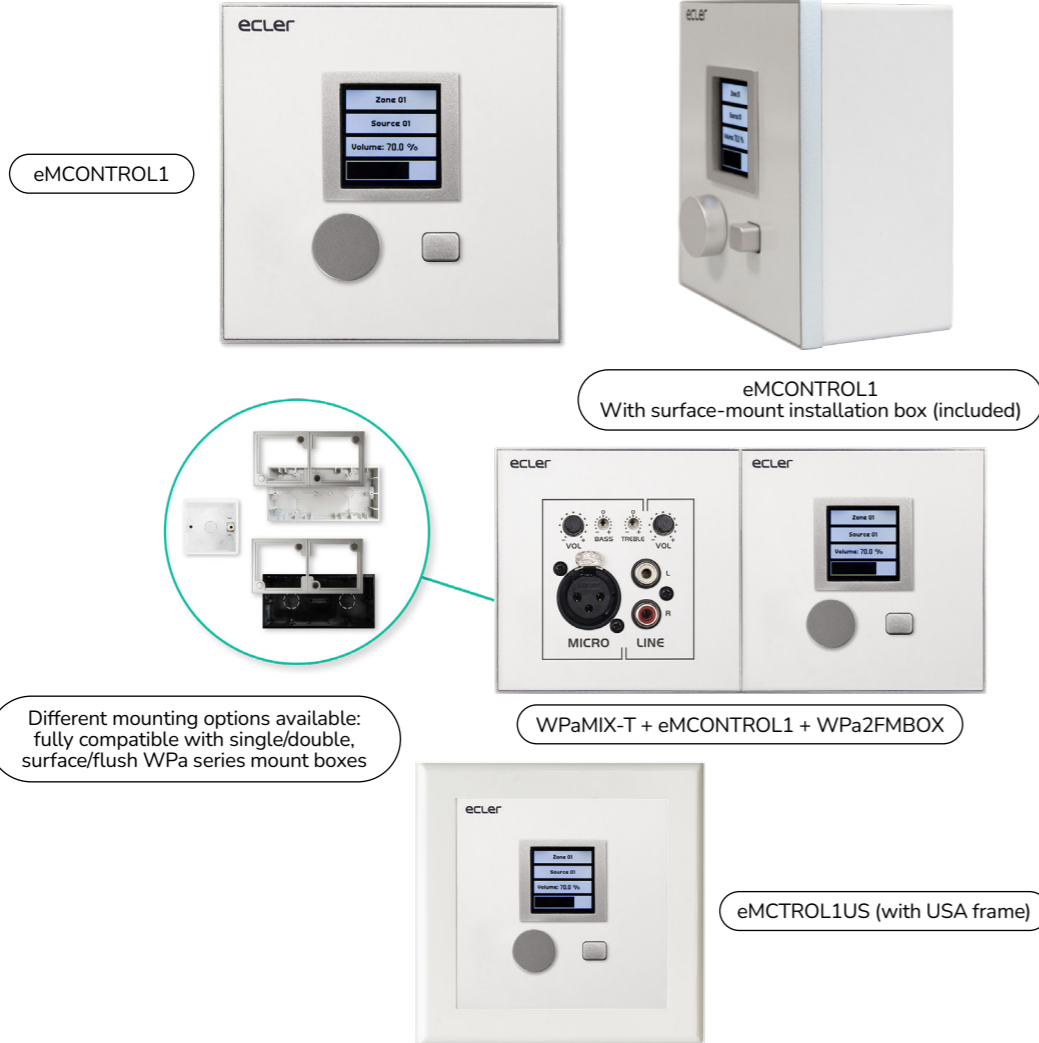

eMCONTROL1

eMCONTROL1  
With surface-mount installation box (included)

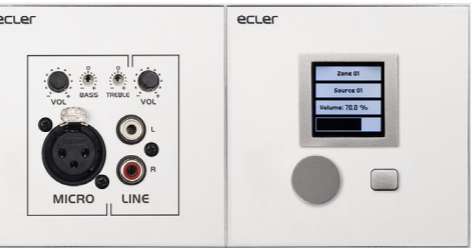

WPaMIX-T + eMCONTROL1 + WPa2FMBOX

Different mounting options available:  
fully compatible with single/double,  
surface/flush WPa series mount boxes



eMCONTROL1US (with USA frame)

## ACCESSORIES

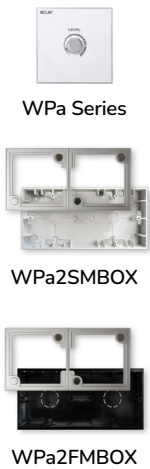

**eMCONTROL1** is a digital control panel for the HUB series zoner with a wall format. It also makes it possible, as an option, to be coupled to a WPa type panel with an audio connector: the pair behaves like a single panel providing remote control + direct sending to the HUB from a balanced audio signal. To do so, it uses a single CAT5 type cable or higher. With exceptions, this does not require its own power supply: remote power supply from a REMOTE port on the HUB.

### KEY FEATURES

- Digital control panel compatible with the HUB
- Volume adjustment, selection of sources and (programmable) EQ
- Compatible with WPa series panels with audio connector, for sending audio and control signals via a single CAT5 cable or higher
- Compatible with wall installation boxes with round shape and internal diameter  $\geq 60$  mm
- Aesthetics designed in collaboration with Italdesign Giugiaro

	eMCONTROL1	eMCONTROL1US
Display	LCD	LCD
Resolution	128x128 Pixels	128x128 Pixels
Connection port	RJ45 remote port	RJ45 remote port
Control keys	Encoder, SELECTION key	Encoder, SELECTION key
Dimensions (WxHxD)	86x86x45mm / 3.38"x3.38"x1.77"	116,5 x 114,75 x 28 mm / 4.58" x 4.51" x 1.10"
Weight	150 g / 0.33 lb	150 g / 0.33 lb

### APPLICATIONS



Remote Controls & Interfaces

# WPaBT / WPaMIX-T

Bluetooth® Receiver Wall Panel / Wall Panel Micro-mixer



Bluetooth®

WPaMIX-TUS  
(WITH USA FRAME)

WPaBT

WPaMIX-T

## ACCESSORIES

### WPaMIX-T:



WP24-PSU



eMCONTROL1

### WPa-BT / WPaMIX-T:



WPa2SMBOX



WPa2FMBOX

**WPaBT** is a Class 1 Bluetooth® receiver with balanced stereo Euroblock output. Surface installation box included.

**WPaMIX-T** is a 2 channel micro-mixer which keeps the standard wall-panel format of the WPa series. It allows to mix a stereo unbalanced signal (2 x RCA) with a microphone signal (XLR), getting a balanced mono output that can be sent to a preamplifier, amplifier, mixer, digital or analogue matrix, etc., thus saving inputs in the receiver device. The MIC input includes a 2 band EQ (BASS, TREBLE) and it can use the talk-over function to override the line signal when the microphone exceeds the talk-over detection threshold. Power supply not included (WP24-PSU)

### KEY FEATURES

#### WPaBT:

- Bluetooth® receiver in WPa wall panel format (standard UE)
- Bluetooth® class 1 (range 25m), version V5.0. A2DP profile
- Balanced stereo Euroblock output dual-mono configurable
- PAIR button with blue LED activity indicator. This can be turned off in dark rooms so as not to disturb
- Easy device name configuration, PIN, stereo/mono output and other adjustments via the Ecler Bluetooth® Manager application for Windows devices
- External 24VDC power supply (WP24-PSU, optional), via terminal strip or via eMCONTROL1 power supply bus
- GPO: to indicate that an A2DP audio connection is active (automatic priority management)
- USB-C configuration port: not visible, behind the front cover. Easily accessed by removing only the front cover; it is not necessary to remove the device from the wall. USB-C cable not included
- Compatible with round electrical boxes that are 60mm in diameter

- Surface mounting box included
- Compatible with WPa2FMBOX and WPa2SMBOX mounting boxes
- It can be combined with an eMCONTROL1 to work as a remote audio input for HUB Series digital zoner

#### WPaMIX-T:

- Unbalanced stereo line input (2xRCA)
- Balanced MIC input with BASS and TREBLE controls and selectable Phantom power
- Independent volume controls for LINE and MIC inputs
- Talk-over function available (MIC over LINE)
- External PSU required. Compatible with WP24-PSU power supply unit
- It can be combined with an eMCONTROL1 to work as a remote audio input for HUB Series digital zoner
- Surface-mount box included
- Available in white colour (RAL 9016)

### APPLICATIONS



Remote Controls & Interfaces





# WPa Series

Remote Controls

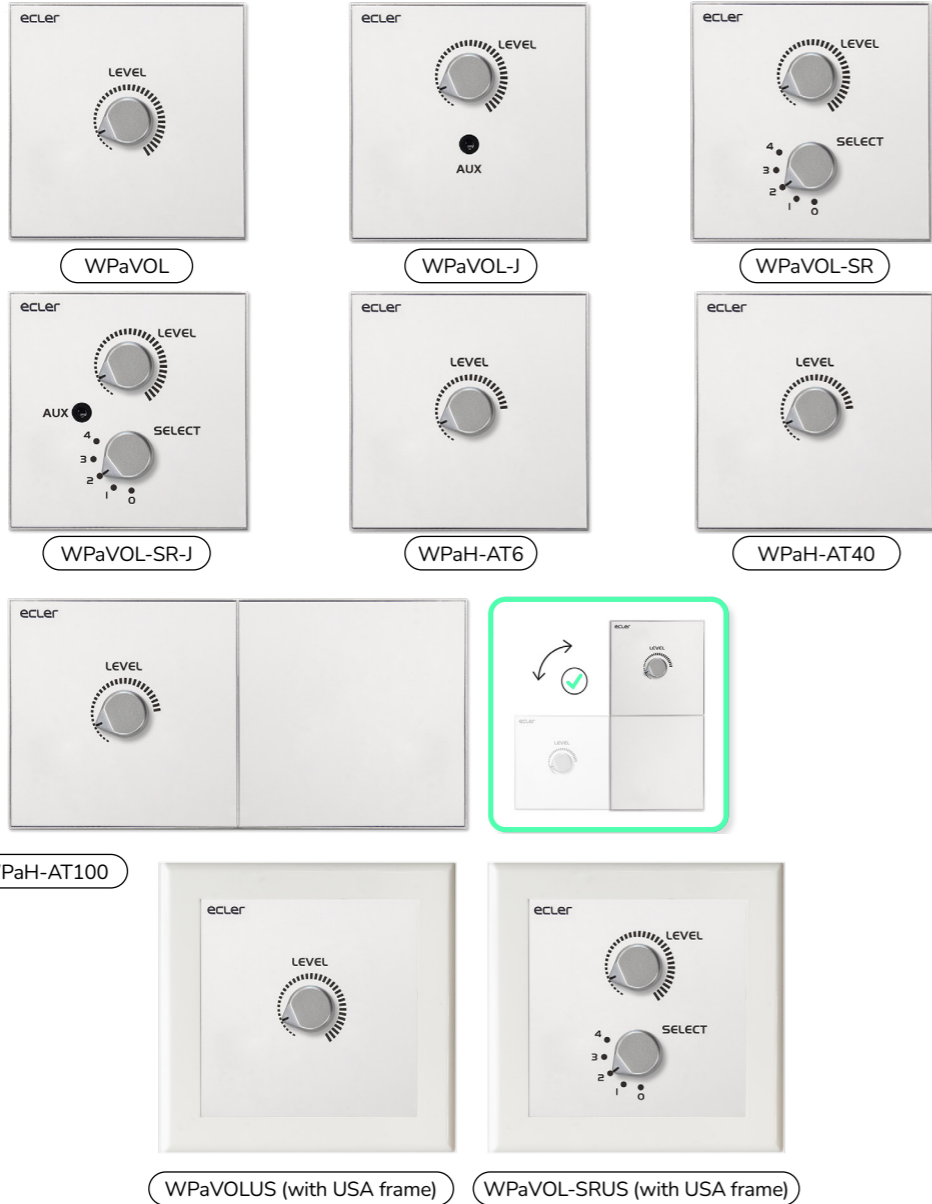

Different mounting options available:  
Fully with single/double, surface/flush WPa series mount boxes

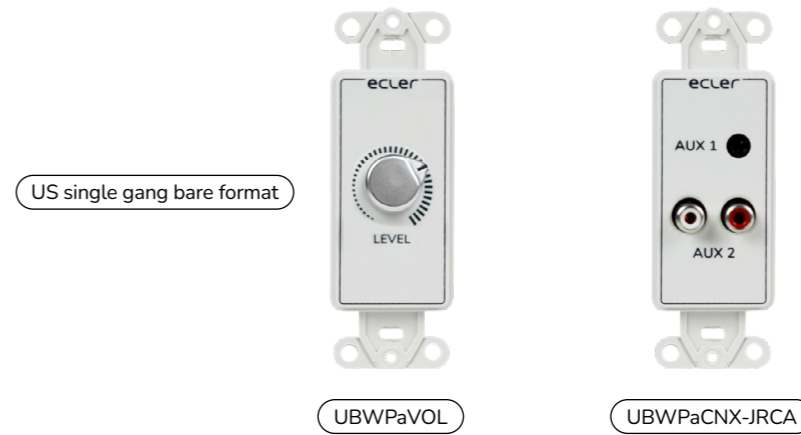

## ACCESSORIES

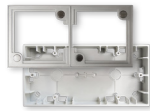

WPa2SMBOX



WPa2FMBOX

**WPa** is a series of remote control wall panels for systems and interconnecting audio signals, with a modern, elegant, discrete aesthetic, designed in collaboration with Italdesign Giugiaro. WPa series includes surface-mount installation box (except UBWPa).

**WPaVOL** is a remote wall panel control for one volume management. Compatible with all 0-10V DC REMOTE control port.

**WPaVOL-J** has the same features as WPa VOL + front panel stereo mini-jack connector.

**WPaVOL-SR** is a remote wall panel control for one volume management + source or preset selection. Compatible with all 0-10V DC REMOTE control port.

**WPaVOL-SR-J** has the same features as WPaVOL-SR + front panel stereo mini-jack connector.

**WPaH-AT6** is a 70 / 100V line attenuator with integrated 24 VDC priority relay. 6W maximum output power.

**WPaH-AT40** is a 70 / 100V line attenuator with integrated 24 VDC priority relay. 40W maximum output power.

**WPaH-AT100** is a 70 / 100V line attenuator with integrated 24 VDC priority relay. 100W maximum output power.

## APPLICATIONS



**WPaCNX-CBO** is a connection Wall Plate with Female 3 pin XLR connector + Jack ST (combo connector). Screw-type connector at the back (no solder needed).

**WPaCNX-JRCA** is a connection Wall Plate with 1 x stereo minijack and 2 x RCA connectors.





Ecler **WP24-PSU** is a 24VDC 0.5A external PSU. International AC plugs set. Coaxial connector (+ center), compatible with eMPAGE, DN44BOB, WPNET Series, eMCONTROL1, WPaMIX-T and WPaBT.

**ETH232AD** is a serial interface that allows bidirectional transparent transmission between RS-232/422/485 and Ethernet. It includes a setting webpage for Ethernet and Serial customized settings.

**1UHRMKIT** is a kit that enables a half-width and 1U height rack device (ePLAYER1, etc.) to be mounted into a standard width rack cabinet.

**2UHRMKIT** is a kit that enables a half-width and 2U height rack device to be mounted into a standard width rack cabinet.

**PUM3** is a rack-mount accessory that allows to mount two half-width RU devices in 1 standard width RU space. Mounting screws included.

**VEO-RACK19** is a universal 19" rack support. Includes velcro and fixing screws.

**LABI1-SWK** is a wheel kit for LABI1-SB18p subwoofer.

**LABI1-SPC** is a nylon protection cover for LABI1-SB18p subwoofer.

**LABI1-CFC** is a flight case for 2 LABI1-C100i + wiring + mounting accessories.



**CNXXLRXLR1/5/10** is a 1m/5m/10m length XLR-XLR cable.

**CNXEbeb1/2M5** is a 1m/2,5m length Euroblock bal.- Euroblock bal. cable.

**CNXEbrca1** is a 1m length 2xEuroblock bal. - 2xRCA Male/female.

**CNXXLRFEB** is a 0,5m length XLR female bal. - Euroblock bal.

**CNXRcaebad** is a RCA - Euroblock bal. adapter.

**CNXMjxlr2** is a 2m length minijack ST to mono XLR male. Includes an internal resistance for overload protection and a proper sum of the signals.

**CNXEblink4** is a 4 Euroblock link cable, 12cm between connectors. It allows to link inputs channels on multichannel amplifiers such as eGPA series.

**CNXac8rm** is a 19" 8 x sockets power strip with ON/OFF switch.

**MBstand** is a microphone stand with boom arm.

**MDstand** is a desktop microphone stand.

**WPa2fmbox** is a double Flush-Mount box, compatible with the WPa wall panel series. It includes a single frame for fitting 2 adjacent panels in a twin housing.

**WPa2smbox** is a double Surface-mount box, compatible with the WPa wall panel series. It includes a single frame for fitting 2 adjacent panels in a twin housing.







**FLATY** is a wall bracket that allows the columns of the MIA series to be installed attached to the wall. It is made of stainless steel and allows the height to be adjusted at any point along the length of the column, as well as allowing 2 columns to be installed side by side on top of each other. Available in black and white.

**HANDY** is a wall bracket compatible with the MIA and NIMBO-14 series. It is incredibly versatile and intelligent with swivel and tilt adjustment, made of stainless steel. Available in black and white.

**IC-TB6** is a tile bridge compatible with IC6 in-ceiling loudspeakers.

**IC-TB8** is a tile bridge compatible with IC8 and IC6CLASS series in-ceiling loudspeakers.

**ARQ108UB** is a U-bracket wall-mount kit compatible with ARQIS108i. Available in white and black finish.

**ARQ110UB** is a U-bracket wall-mount kit compatible with ARQIS110i. Available in white and black finish.

**ARQ112UB** is a U-bracket wall-mount kit compatible with ARQIS112i. Available in white and black finish.

**SR12** is a mount bracket for ARQIS110i and ARQIS112i loudspeakers.

**POLE01** is an adjustable 35 mm rod for pole for loudspeaker mount on top of a sub-woofer unit (ARQIS110i on top of ARQISSB15, etc.).

**AVICCAN6L** is an 6" low-profile back can, compatible with VIC6.

**AVICCAN8L** is an 8" low-profile back can, compatible with VIC8/VIC8SB.



**GROUNDY** is a bracket that allows you to install eMOTUS series speakers on the floor. Compatible with eMOTUS3OD, eMOTUS5P, eMOTUS5PB and eMOTUS5OD. Available in black colour.

**CEILY** is a bracket that allows eMOTUS series speakers to be mounted on the ceiling. Compatible with eMOTUS3OD, eMOTUS5P, eMOTUS5PB and eMOTUS5OD. Available in black and white.

**RAILAPTOR** is an adapter for hanging eMOTUS5OD or AUDEO103/106 loudspeakers from a ceiling light rail.

**LABI1-SAC** is a subwoofer-adapter-column, to install the LABI1-C100i satellite loudspeaker on LABI1-SB18p.

**LABI1-CAC** is a column-adapter-column, to connect vertically two LABI1-C100i column loudspeakers. Includes 60cm Speakon®-Speakon® cable.

**LABI1-TBC** is a support to install a LABI1-C100i loudspeaker to truss.

**LABI1-WBC** is a LABI1-C100i wall mount bracket.

**LABI1-PBC** is a pole adaptor to install LABI1-C100i loudspeakers in a 35mm standard pole.

**LABI1-HBC** are high-density foam pieces to let LABI1-C100i rest on the floor horizontally. Allows 0°/ 30°/ 45° inclinations relative to the horizontal surface.

**LABI1-ODCNX** is an outdoor kit to cover LABI1-C100i connections and make it ready for outdoor applications.



# Accessories

## Compatibility Chart

(2) Using specific retro-compatible firmware (except WPNETEX)  
 (3) When including WPaMIX-T

(4) When including eMPAGE  
 (5) When including 1UHRMKIT  
 (6) Future firmware version necessary. Schedule pending.

■ Full compatible  
 ■ Compatible with some models (check particular model)  
 ■ Not compatible

	PLAYER ONE / ZERO	DUO-NET PLAYER	eSAM Series	SAM / I Series	eCOMPACT4BT	MIMO DANTE	MIMO / MIMOSG Series	DN44BOB	HUB	DAM614	NXA Series	ALMA Series	VIDA Series	HADA Series	AURA Series	eGPA Series	GPA Series	eHSA Series
MPAGE1	-	-	■	■	■	■	■	■	■	■	■	■	■	■	■	■	■	■
MPAGE4	-	-	■	■	■	■	■	■	■	■	■	■	■	■	■	■	■	■
eMPAGE	-	-	■	■	■	■	■	■	■	■	■	■	■	■	■	■	■	■
PULSO Series	-	■	■	■	■	■	■	(6)	■	■	■	■	■	■	■	■	■	■
PAGENETDN	-	■	■	■	■	■	■	■	■	■	■	■	■	■	■	■	■	■
WPNETTOUCH	-	■	■	■	■	■	■	■	■	■	■	■	■	■	■	■	■	■
WPNET Series	-	■	■	■	■	(2)	■	■	■	(2)	■	■	■	■	■	■	■	■
WP22DN	-	■	■	■	■	■	■	■	■	■	■	■	■	■	■	■	■	■
eMCONTROL1	-	■	■	■	■	■	■	■	■	■	■	■	■	■	■	■	■	■
WPaVOL	-	■	■	■	■	■	■	■	■	■	■	■	■	■	■	■	■	■
WPaVOL-J	-	■	■	■	■	■	■	■	■	■	■	■	■	■	■	■	■	■
WPaVOL-SR	-	■	■	■	■	■	■	■	■	■	■	■	■	■	■	■	■	■
WPaVOL-SR-J	-	■	■	■	■	■	■	■	■	■	■	■	■	■	■	■	■	■
WPaH-AT40	-	■	■	■	■	■	■	■	■	■	■	■	■	■	■	■	■	■
WPaH-AT100	-	■	■	■	■	■	■	■	■	■	■	■	■	■	■	■	■	■
WPaMIX-T	-	■	■	■	■	■	■	■	■	■	■	■	■	■	■	■	■	■
WPaBT	-	■	■	■	■	■	■	■	■	■	■	■	■	■	■	■	■	■
WPaCNX-CBO	-	■	■	■	■	■	■	■	■	■	■	■	■	■	■	■	■	■
WPaCNX-JRCA	-	■	■	■	■	■	■	■	■	■	■	■	■	■	■	■	■	■
ETH232AD	-	■	■	■	■	■	■	■	■	■	■	(3)	(3)	■	■	■	■	■
WP24-PSU	-	■	(3)	(3)	(3)	(3)	(3)	(3)	(3)	(3)	(3)	(3)	(3)	(3)	(3)	(3)	(3)	■
VEO-RACK19	■	■	■	■	■	■	■	■	■	■	■	■	■	■	■	■	■	■
2UHRMKIT	■	■	■	■	■	■	■	■	■	■	■	■	■	■	■	■	■	■
1UHRMKIT	■	■	■	■	■	■	■	■	■	■	■	■	■	■	■	■	■	■
PUM3	(5)	■	■	■	■	■	■	■	■	■	■	■	■	■	■	■	■	■
FLATY	■	■	■	■	■	■	■	■	■	■	■	■	■	■	■	■	■	■
HANDY	■	■	■	■	■	■	■	■	■	■	■	■	■	■	■	■	■	■
CEILY	■	■	■	■	■	■	■	■	■	■	■	■	■	■	■	■	■	■
GROUNDY	■	■	■	■	■	■	■	■	■	■	■	■	■	■	■	■	■	■
SR12	■	■	■	■	■	■	■	■	■	■	■	■	■	■	■	■	■	■
ARQ108UB	■	■	■	■	■	■	■	■	■	■	■	■	■	■	■	■	■	■
ARQ110UB	■	■	■	■	■	■	■	■	■	■	■	■	■	■	■	■	■	■
ARQ112UB	■	■	■	■	■	■	■	■	■	■	■	■	■	■	■	■	■	■
ARQSB10SATB	■	■	■	■	■	■	■	■	■	■	■	■	■	■	■	■	■	■
POLE01 / TRIPO1	■	■	■	■	■	■	■	■	■	■	■	■	■	■	■	■	■	■
AVICCAN6L / 8L	■	■	■	■	■	■	■	■	■	■	■	■	■	■	■	■	■	■
AVICSG / AVICRG	■	■	■	■	■	■	■	■	■	■	■	■	■	■	■	■	■	■
LABI1 Series	■	■	■	■	■	■	■	■	■	■	■	■	■	■	■	■	■	■
IC TB Series (tile bridge)	■	■	■	■	■	■	■	■	■	■	■	■	■	■	■	■	■	■
PKIC Series (paint)	■	■	■	■	■	■	■	■	■	■	■	■	■	■	■	■	■	■

	HSA Series	HZA Series	eHMA Series	HMA Series	eCA Series	CA Series	VIC Series	IC Series	DROP	NIMBO Series	MIA Series	ZEN-15	KICK-SB28	EDGE-SB110P	AMBIT Series	eMOTUS Series	AUDEO Series	ARQIsi Series	LABI Series	
MPAGE1	-	-	■	■	■	■	■	■	■	■	■	■	■	■	■	■	■	■	■	■
MPAGE4	-	-	■	■	■	■	■	■	■	■	■	■	■	■	■	■	■	■	■	■
eMPAGE	-	-	■	■	■	■	■	■	■	■	■	■	■	■	■	■	■	■	■	■
PULSO Series	-	-	■	■	■	■	■	■	■	■	■	■	■	■	■	■	■	■	■	■
PAGENETDN	-	-	■	■	■	■	■	■	■	■	■	■	■	■	■	■	■	■	■	■
WPNETTOUCH	-	-	■	■	■	■	■	■	■	■	■	■	■	■	■	■	■	■	■	■
WPNET Series	-	-	■	■	■	■	■	■	■	■	■	■	■	■	■	■	■	■	■	■
WP22DN	-	-	■	■	■	■	■	■	■	■	■	■	■	■	■	■	■	■	■	■
eMCONTROL1	-	-	■	■	■	■	■	■	■	■	■	■	■	■	■	■	■	■	■	■
WPaVOL	■	■	■	■	■	■	■	■	■	■	■	■	■	■	■	■	■	■	■	■
WPaVOL-J	■	■	■	■	■	■	■	■	■	■	■	■	■	■	■	■	■	■	■	■
WPaVOL-SR	-	-	■	■	■	■	■	■	■	■	■	■	■	■	■	■	■	■	■	■
WPaVOL-SR-J	-	-	■	■	■	■	■	■	■	■	■	■	■	■	■	■	■	■	■	■
WPaH-AT40	■	■	■	■	■	■	■	■	■	■	■	■	■	■	■	■	■	■	■	■
WPaH-AT100	■	■	■	■	■	■	■	■	■	■	■	■	■	■	■	■	■	■	■	■
WPaMIX-T	■	■	■	■	■	■	■	■	■	■	■	■	■	■	■	■	■	■	■	■
WPaBT	■	■	■	■	■	■	■	■	■	■	■	■	■	■	■	■	■	■	■	■
WPaCNX-CBO	■	■	■	■	■	■	■	■	■	■	■	■	■	■	■	■	■	■	■	■
WPaCNX-JRCA	■	■	■	■	■	■	■	■	■	■	■	■	■	■	■	■	■	■	■	■
ETH232AD	-	-	■	■	■	■	■	■	■	■	■	■	■	■	■	■	■	■	■	■
WP24-PSU	-	(3)	(3)	(3)	(3)	(3)	■	■	■	■	■	■	■	■	■	■	■	■	■	■
VEO-RACK19	-	-	■	■	■	■	■	■	■	■	■	■	■	■	■	■	■	■	■	■
2UHRMKIT	-	-	■	■	■	■	■	■	■	■	■	■	■	■	■	■	■	■	■	■
1UHRMKIT	-	-	■	■	■	■	■	■	■	■	■	■	■	■	■	■	■	■	■	■
PUM3	-	-	■	■	■	■	■	■	■	■	■	■	■	■	■	■	■	■	■	■
FLATY	-	-	■	■	■	■	■	■	■	■	■	■	■	■	■	■	■	■	■	■
HANDY	-	-	■	■	■	■	■	■	■	■	■	■	■	■	■	■	■	■	■	■
CEILY	-	-	■	■	■	■	■	■	■	■	■	■	■	■	■	■	■	■	■	■
GROUNDY	-	-	■	■	■	■	■	■	■	■	■	■	■	■	■	■	■	■	■	■
SR12	-	-	■	■	■	■	■	■	■	■	■	■	■	■	■	■	■	■	■	■
ARQ108UB	-	-	■	■	■	■	■	■	■	■	■	■	■	■	■	■	■	■	■	■
ARQ110UB	-	-	■	■	■	■	■	■	■	■	■	■	■	■	■	■	■	■	■	■
ARQ112UB	-	-	■	■	■	■	■	■	■	■	■	■	■	■	■	■	■	■	■	■
ARQSB10SATB	-	-	■	■	■	■	■	■	■	■	■	■	■	■	■	■	■	■	■	■
POLE01 / TRIPO1	-	-	■	■	■	■	■	■	■	■	■	■	■	■	■	■	■	■	■	■
AVICCAN6L / 8L	-	-	■	■	■	■	■	■	■	■	■	■	■	■	■	■	■	■	■	■
AVICSG / AVICRG	-	-	■	■	■	■	■	■	■	■	■	■	■	■	■	■	■	■	■	■
LABI1 Series	-	-	■	■	■	■	■	■	■	■	■	■	■	■	■	■	■	■	■	■
IC TB Series (tile bridge)	-	-	■	■	■	■	■	■	■	■	■	■	■	■	■	■	■	■	■	■
PKIC Series (paint)	-	-	■	■	■	■	■	■	■	■	■	■	■	■	■	■	■	■	■	■



# Products Video





# VEO-SWM44

4K 4X1 Presentation Switcher with VEOCast

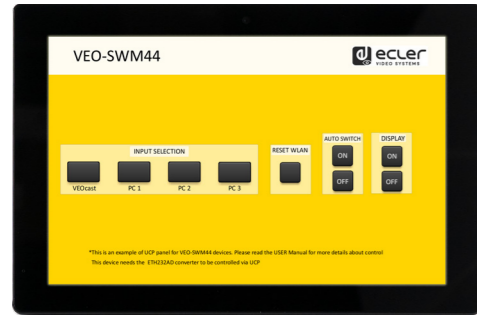

VEO-SWM44

**VEO-SWM44** is a compact 4K presentation switcher that includes 2 HDMI 2.0, a USB-C and wireless input selection via VEOCast to a single HDMI 2.0 output.

### KEY FEATURES

- Bandwidth up to 18Gbps, resolution up to 4k @60hz YUV 4:4:4
- Support HDR10, Dolby Vision
- Wireless BYOD (bring your own device) capability via VEOCast (for iOS, Android, Windows and MacOS devices)
- Provide up to 60w charging, USB data and 4K video over USB-C
- HDMI Audio de-embedded via balanced analogue audio port on Euroblock connectors
- HDCP2.2 Compliant
- EDID Smart Management (via dip-switch)
- Switching function via front panel, auto-switching function, RS-232
- Configuration via web-page (WiFi)
- Send CEC and RS-232 commands for display control



Switchers



# VEO-SWH44

HDMI 2.0 4X1 18Gbps Switcher with Audio De-embedder and RS-232 Control



VEO-SWH44

**VEO-SWH44** is a 4x1 HDMI switcher for high dynamic range (HDR) formats. It is the ideal solution for applications requiring 4K/UHD and HDR sources and displays. VEO-SWH44 includes audio de-embedding features and audio EDID management. The HDMI selection could be automatic (sense selection) and manual (frontal panel, remote control or serial commands). The controls include ARC mute and LED indications of the selected sources and settings.

### KEY FEATURES

- 4x1 Ultra High Definition sources selector compliant with HDMI 2.0a standards
- Video formats up to 4Kx2K(4096x2160@60Hz YUV 4:4:4) and all HDMI 3D video formats and all HDMI
- Supports HDR and 3D contents
- HDCP2.2/1.4 Compliant
- Supports 36 bit Deep Color
- Smart EDID management (Auto/2CH/5.1CH/7.1CH selectable)
- PCM, Dolby TrueHD, DTS-HD Master Audio up to 7.1CH
- Supports Audio Return Channel (ARC)
- Digital and analog audio output
- RS-232 Control
- Supports up to 18Gbps video data rate



Switchers





# VEO-SWC44 / 44TH 44TU

Wireless Conferencing and Presentation Switcher / HDMI wireless transmitter / USB-C wireless transmitter



**VEO-SWC44** is a wireless conferencing and presentation switcher with Full HD video resolution wireless inputs and a 4K / UHD HDMI 2.0 video output. It supports wireless connection for USB devices like webcam and mic via dongle, Windows & macOS applications and is also Airplay / Miracast compliant. An integrated audio de-embedder provides stereo unbalanced analogue output on a 3,5mm jack connector. It includes a WebGUI for configuration and management as well as RS-232, TCP/IP remote control, all enabled by a pair of LAN RJ-45 connectors with independent networks available.

## KEY FEATURES

- USB 3.0 ports for wireless connection between a laptop and room USB devices like camera and mic for an easy video conference
- Wireless input up to Full HD video resolution and a HDMI 2.0 4K / UHD video output
- Analogue audio extraction on stereo unbalanced 3,5mm jack connector
- Support for native wireless mirroring protocols like Airplay and Miracast for a flawless presentation
- Plug-n-play by optional wireless transmitters HDMI VEO-SWC44TH or USB Type-C VEO-SWC44TU as well as Windows and macOS apps for wireless connection with a laptop or PC
- RS-232 and IP control as well as WebGUI management
- Extra security layer for an encrypted wireless transmission.
- Support for up to 4 simultaneous split screen view presentation as well as up to 16 participants on hold
- Customizable background image or logo for the welcome screenpage
- Support wireless touchback for interactive screen as well as whiteboard and live annotation tool.
- Support for PoE
- Local 12V DC power supply



Switchers



# VEO-MXH44D

HDMI 2.0 4X4 18Gbps Matrix with Audio De-embedders and Display



VEO-MXH44D

**VEO-MXH44D** is a 4x4 HDMI 2.0 matrix with support for up to 4K/UHD video resolution, 60 Hz and 4:4:4 chroma sampling. It includes 8 analogue and digital audio de-embedding outputs as well as EDID management, a LCD display and an integrated WebGUI that allows to configure and control the unit in a very user friendly way. The HDMI sources can be addressed using the frontal panel's selection buttons or via serial commands, TCP/IP, and IR. It is also HDCP 2.2 and 1.4 compliant. VEO-MXH44D can load and launch up to 8 presets which makes it a very interesting solution for professional applications that require video and audio HDMI signals routing between 4K/UHD sources and displays with a smart control management.

## KEY FEATURES

- 4 x HDMI 2.0 inputs which can be independently routed to 4 x HDMI 2.0 outputs
- Supports HDMI 2.0 up to 4K @60Hz, YUV 4:4:4 8-bit, HDR (at 4K @60Hz YUV 4:2:0 10-bit)
- Support for Full HD video downscaling
- 8 preset storage
- Supports audio formats including Dolby TrueHD, Atmos; DTS-HD Master Audio and DTS:X transmissions
- Analogue audio extraction on stereo unbalanced Euroblock connector as well as stereo and surround digital audio extraction on S/PDIF coaxial connector
- Control via front panel and display, IR remote, RS-232 control, IP control and WebGUI
- Advanced EDID management
- HDCP 2.2 compliant
- Local 12V DC power supply



Matrixes





# VEO-MXH88D

HDMI 2.0 8X8 18Gbps Matrix with Audio De-embedders and Display

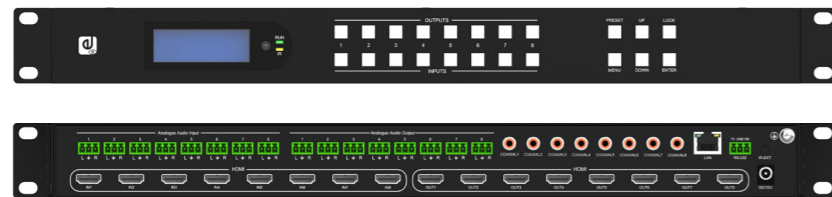

VEO-MXH88D

**VEO-MXH88D** is a 8x8 HDMI 2.0 matrix with support for up to 4K/UHD video resolution, 60 Hz and 4:4:4 chroma sampling. It includes 8 analogue audio inputs and 16 analogue and digital audio de-embedding outputs as well as EDID management, a LCD display and an integrated WebGUI that allows to configure and control the unit in a very user friendly way. The HDMI sources can be addressed using the frontal panel's selection buttons or via serial commands, TCP/IP, and IR. It is also HDCP 2.2 and 1.4 compliant. VEO-MXH88D can load and launch up to 8 presets which makes it a very interesting solution for professional applications that require video and audio HDMI signals routing between 4K/UHD sources and displays with a smart control management.

### KEY FEATURES

- 8 x HDMI 2.0 inputs which can be independently routed to 8 x HDMI 2.0 outputs
- Supports HDMI 2.0 up to 4K @60Hz, YUV 4:4:4 8-bit, HDR (at 4K @60Hz YUV 4:2:0 10-bit)
- 8 preset storage
- Supports audio formats including Dolby TrueHD, Atmos, DTS-HD Master Audio and DTS:X transmissions
- Analogue audio insertion and extraction on stereo unbalanced Euroblock connectors as well as stereo and surround digital audio extraction on S/PDIF coaxial connector
- Control via front panel and display, IR remote, RS-232 control, IP control and WebGUI
- Advanced EDID management, CEC, ARC
- HDCP 2.2 compliant
- Local 12V DC power supply



Matrixes



# VEO-SPH48 / 44 / 42

HDMI 2.0 Splitter 1X8 / 1X4 / 1X2

Splitters



VEO-SPH48



VEO-SPH44



VEO-SPH42

**VEO-SPH48** splitter for high dynamic range (HDR) formats. Simultaneously displays an Ultra Hi-Definition source on up to eight Ultra HD displays. It includes EDID management features.

**VEO-SPH44** splitter for high dynamic range (HDR) formats. Simultaneously displays an Ultra Hi-Definition source on up to four Ultra HD displays.

**VEO-SPH42** splitter for high dynamic range (HDR) formats. Simultaneously displays an Ultra Hi-Definition source on up to two Ultra HD displays.

### KEY FEATURES

- Supports resolutions up to 4Kx2K(4096x2160@60Hz YUV 4:4:4 )
- Three EDID setting modes
- HDCP2.2/1.4 Compliant
- Supports 36 bit Deep Color
- Supports LPCM 7.1, Dolby TrueHD, Dolby digital Plus, and DTS-HD Master Audio
- Supports HDR and 3D contents
- Supports up to 18Gbps video data rate
- Front panel LED indicators for power and signal status





# VEO-XT11CG2 / XRI1CG2

H.265 Full HD over IP Video Extender

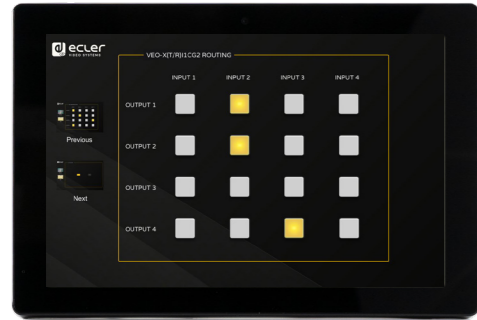

VEO-XT11CG2



VEO-XRI1CG2



VEO-XT11CG2



VEO-XRI1CG2

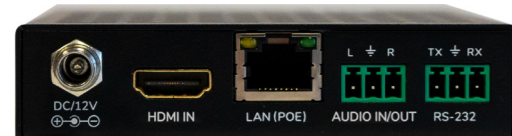

VEO-XT11CG2 transmitter and VEO-XRI1CG2 receiver are a H.265 / H.264 over IP set of extenders that allow for HDMI distribution over 1Gb Ethernet networks with up to 1080p@60Hz video support. These devices represent a professional high quality compression and low bandwidth solution aimed for point-to-point, as well as multipoint-to-multipoint scenarios over a single 100m Cat5e/6/7 cable. VEO-XT11CG2 and VEO-XRI1CG2 are widely suitable for various applications which also require PoE, audio management, video wall compositing or RS-232 control, such as educational, commercial or corporate installations, where flexible and scalable AV systems are in need. Furthermore, this encoder and decoder can be paired with VEO-XCTRLG2 control module for an expanded management experience with in-built WEB configuration interface.

## KEY FEATURES

- HDMI 1.4 with video resolution up to 1920x1200p@60Hz 4:4:4
- Signal transmission distance up to 100m over Cat5e/6/7 cable
- Support for unicast over 1Gb unmanaged networks and multicast signal extension over 1Gb managed networks
- Support for video wall compositing up to 9 x 9 setups
- Support for audio embedding and extraction
- Support main stream and sub stream encoding modes
- Support for pass through and RS-232, TCP/IP, WebGUI management using VEO-XCTRLG2 controller module
- HDCP 1.4 compliant
- Support for PoE function
- Local 12V DC power supply

FULLHD HDMI PoE

Video Distribution over IP



# VEO-XCTRLG2

H.265 Full HD over IP Video Extender Controller



VEO-XCTRLG2

VEO-XCTRLG2 is a controller module that allows the user to manage and operate VEOXT11CG2 and VEO-XRI1CG2 video over IP devices in large multipoint-to-multipoint systems. It mounts two dedicated LAN ports to host independent Control and Video networks. VEO-XCTRLG2 offers a dedicated web interface that features a setup wizard, matrix control, videowall smart creation and operation, drag and drop source selection, video preview and TCP and RS-232 control commands. It supports POE function which makes this advanced managing tool a perfect fit more all sorts of AV over IP installations.

## KEY FEATURES

- Easy to create project, control and manage the system
- Setup wizard to easy assign devices to a project including Auto, DHCP and Manual IP configurations
- HTTPS, SSH, SFTP security compatible
- Built-in Web GUI control interface, supporting Drag & Drop operations
- Support image preview
- Support video, audio, RS-232, control and management of the distributed system
- Two dedicated LAN ports to host independent Control and Video networks
- Support TCP and RS-232 port control and third-party central control
- Multiple circuits protection, lightning protection and ESD design
- Reliable system design, ensuring 7\*24 hours reliable and stable work
- PoE functionality

FULLHD HDMI PoE

Video Distribution over IP





# VEO-XTI2L / XRI2L

Low latency 4K over IP Video Extenders with KVM and Videowall features



VEO-XRI2L



VEO-XTI2L



VEO-XRI2L



VEO-XTI2L

VEO-XTI2L and VEO-XRI2L are low latency 4K HDMI extenders over IP. They also provide optional fiber optic connection for extension of 4K signals up to 2Km. This over IP solution is widely suitable for all the applications that require low latency video extension such as real time application or KVM. An intuitive user panel with LEDs display allows to select the stream channel just out of the box, without the need of connecting a PC. The extenders can be power supplied both via PoE or via the included external PSU. Web browser interface, PC tools and third party control protocol are available for advanced settings and advanced control.

## KEY FEATURES

- Support Video Wall composition (Max 8x8)
- 4K UHD HDMI over IP/Fiber Extension
- Support point-to-point, point-to-multipoint and multipoint-to-multipoint configurations
- USB2.0 over IP extension for KVM
- Support transmission distances up to 120m over single Cat.5e/6 cable
- Support fiber optic extensions up to 60Km (Single Mode)
- Support up to 4K@60Hz YUV 4:2:0 input and 4K@30Hz outputs
- HDCP 2.2 / HDCP1.4 compliant
- Support Bi-Directional Wide Band IR (38kHz-56kHz) Pass through
- Support RS-232 pass through and Telnet control (EclerNet Manager and third party remote control compatible)
- Include IR remote/ Frontal Panel control of Group ID channel, with LED display to show the Group ID in use
- Support Dolby True HD, DTS-HD Master Audio formats
- Support 3D video formats
- SPDIF 5.1 and L/R analog stereo embedding and de-embedding
- Easy installation over Gigabit, IGMP Snooping, Jumbo Frame compliant LAN Networks
- The extenders can be powered with PoE or with the included external power supply

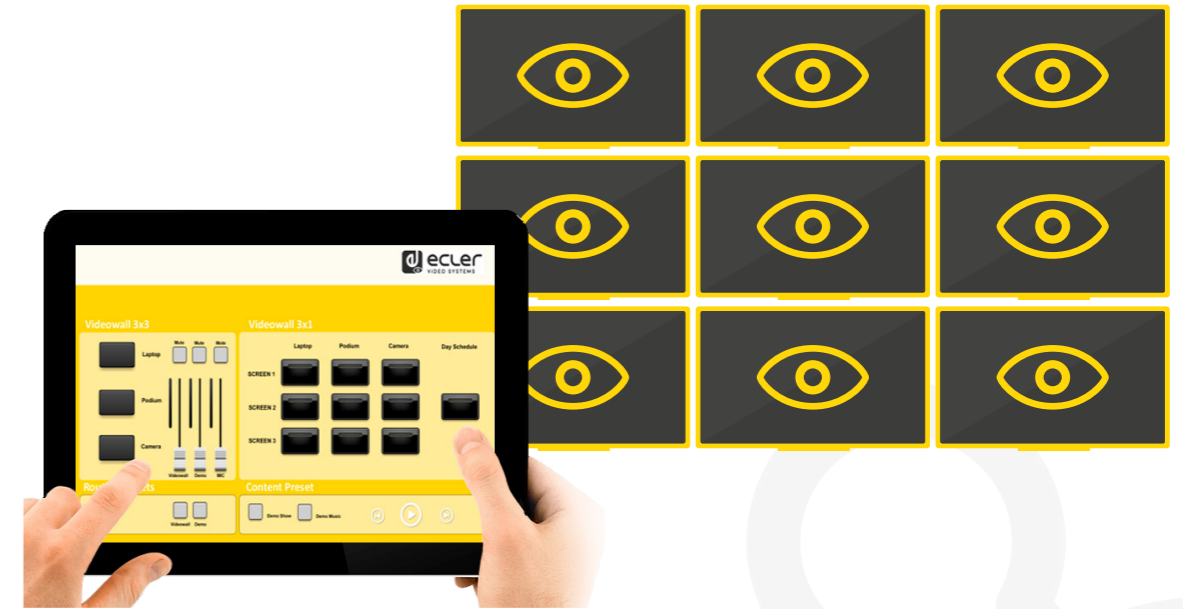

## CONTROL VIDEO WITH ECLERNET MANAGER

VEO-XTI2L and VEO-XRI2L become native EclerNet products, thanks to the new firmware update 2.0.

This important step allows offering to pro AV installers a unique platform for installation and commissioning of Audio and Video distribution systems.

In addition, by creating UCP panels, it is possible to create fully customizable graphical interfaces for simple and immediate control through WPNETTOUCH controllers or using the different control options offered by EclerNet, such as control via WEB or through Android® / iOS® devices installing the UCP Ecler app.

Therefore, this important innovation opens the doors to the EclerNet platform for all applications where the integration of Audio Video and Control is required. The new software and firmware will add the following features:

- VEO-XTI2L and VEO-XRI2L device discovery
- The software will automatically detect the devices in the network and they will appear in the "Device List"
- VEO-XTI2L and VEO-XRI2L configuration
- Network and Device configuration windows allow to easily change IP address and basic, and advanced device options, including videowall composing options, in order to simplify the commissioning process

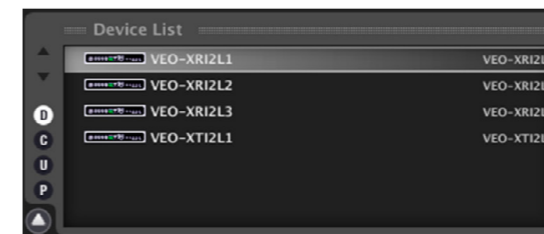



# VEO-XWT44E

Selector / Transmitter panel 4K HDBaseT 18Gbps

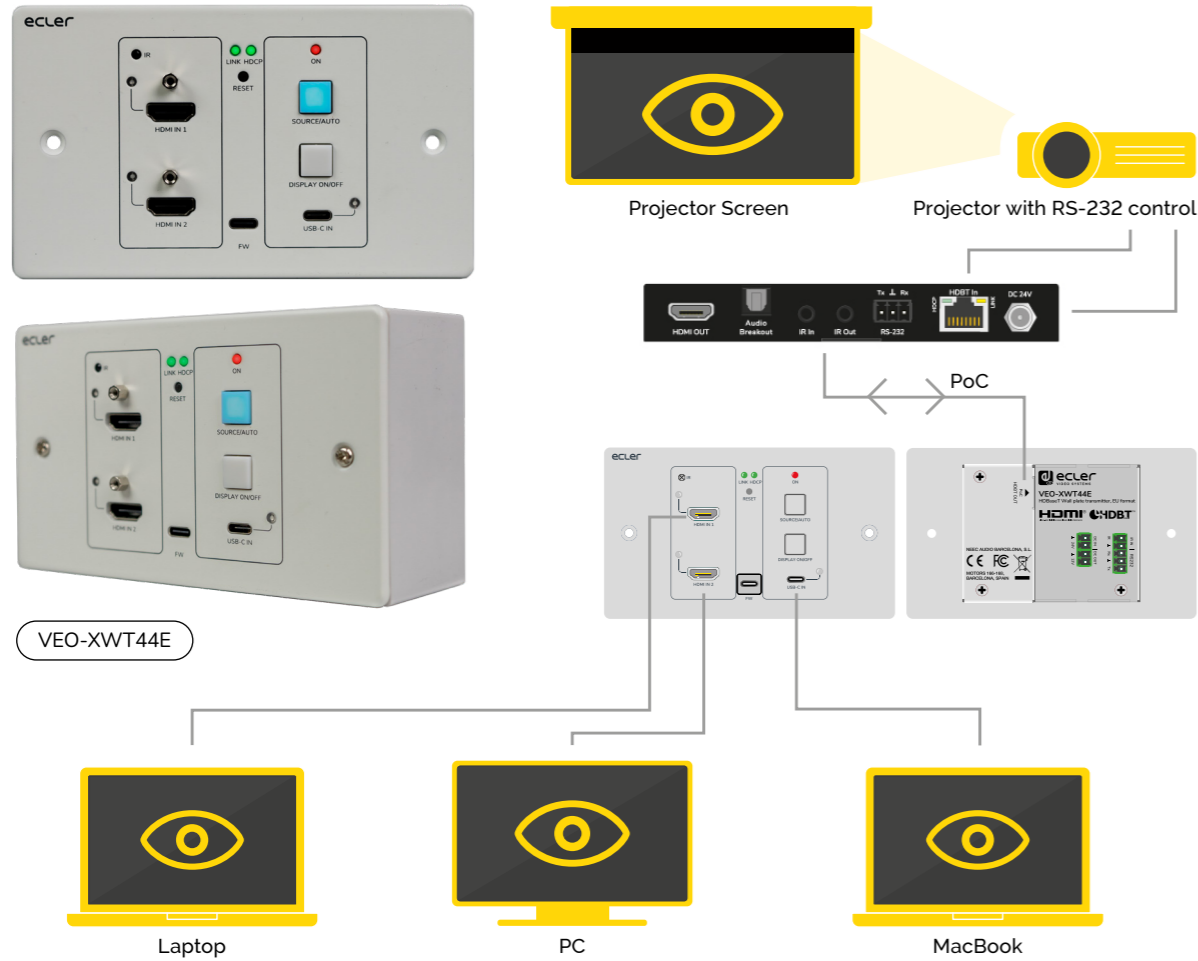

VEO-XWT44E

Laptop

PC

MacBook

**VEO-XWT44E** is a HDBaseT transmitter in European 2-gang wallplate format. It allows to extend one 4K video signal up to 40m over a single Cat 5e/6 cable or a FullHD signal up to 70m when connected to VEO-XRT44. It supports real 4K video signals at 60Hz with 4:4:4 YUV chroma subsampling and HDR 10 with a maximum bandwidth of 18Gbps. With bidirectional PoC feature, the transmitter can be powered by the receiver and vice versa. A second front panel button can be used to switch ON/OFF a display via CEC or it can be alternatively programmed by IR learning or RS-232 to send two RS-232 commands, offering a simple and versatile control option.

## KEY FEATURES

- 4K HDMI wall-plate transmitter with 2 HDMI IN, and 1 USB-C IN
- Supports HDMI 2.0, 4Kx2K/60Hz/4:4:4
- HDCP 2.2 compliant
- Video source auto-switching
- Video lossless compression for HDBaseT technology, transmission up to 40m@4K and 70m@1080p over CATx cable
- Displays can be turned ON/OFF via CEC & RS-232 commands by 'DISPLAY ON/OFF' button
- RS-232 and IR pass through
- IR learning to control display on/off
- EDID pass through and smart managing
- Two-way PoC Supports CEC pass-through
- Provides LEDs to indicate the current operating status
- Firmware upgrade by Micro-USB port
- ESD protection



4K HDBaseT Extender

# VEO-XTT44 / XRT44

Transmitter / Receiver 4K hdbaset 18Gbps



VEO-XRT44

VEO-XTT44

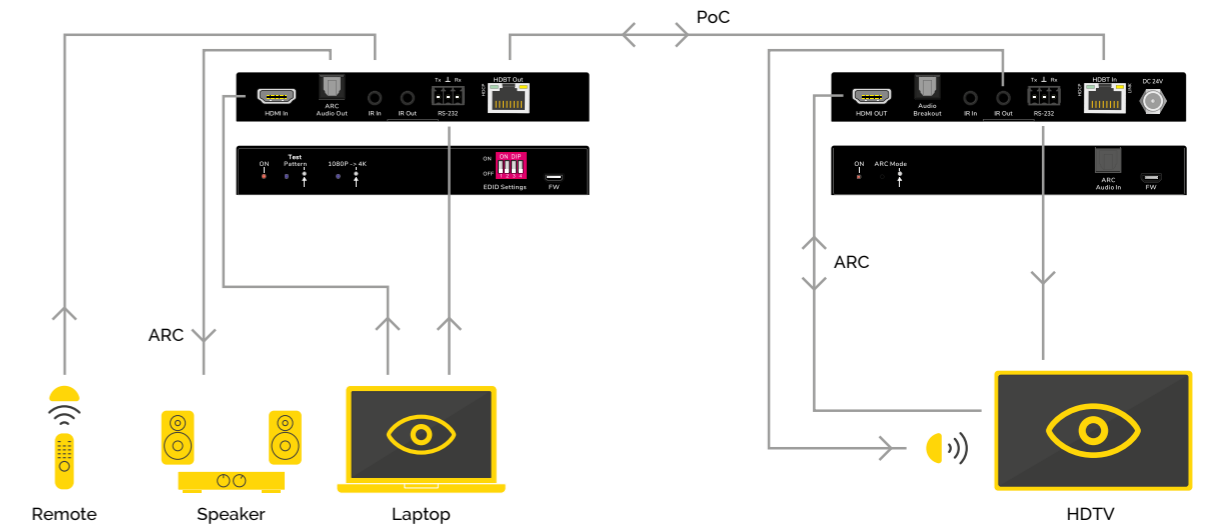

Remote

Speaker

Laptop

HDTV

Ecler **VEO-XTT44** and **VEO-XRT44** are professional HDBaseT transmitter and receiver for HDMI 2.0 extension of High Dynamic Range (HDR) formats. Bidirectional PoH (Power Over HDBaseT) allows to use only one power supply connected to the Transmitter or the Receiver, according to the installation needs. This product represents the ideal solution for residential and commercial applications that include the latest 4K/UHD and HDR sources and displays.

## KEY FEATURES

- Supports HDMI 2.0 and the HDMI video resolution up to 4K@60Hz 4:4:4 HDR
- HDCP 2.2 and 1.4 supported
- Extends 4K signals to distances up to 40 meters (131 feet) and 1080P signals to distances up to 70 meters (230 feet) over a single CATx cable
- Supports video resolution up-scaling, the 1080P input can be automatically upgraded to 4K output
- SPDIF out on receiver for source audio de-embedding
- 18Gbps high bandwidth
- Advanced EDID management: multiple built-in EDID settings or customized EDID can be selected
- Test pattern provides a built-in 4K/1080P image for troubleshooting
- Bidirectional IR, RS232 and 24V PoH
- Supports ARC
- Supports CEC pass-through
- Provides LEDs to indicate the current operating status
- Firmware upgrade by Micro-USB port
- ESD protection



4K HDBaseT Extender



# VEO-XPT44A / XPT24

HDMI 2.0 HDBaseT Extender Kit 18Gbps with Audio Extraction / 4K HDBaseT Extender KIT 10.2Gbps



VEO-XPT44A

VEO-XPT24

**VEO-XPT44A** is a professional HDBaseT extension kit that includes a transmitter and a receiver. It allows to extend a 4K video signal up to 40m or a Full HD signal up to 70m over a single Cat 5e/6 cable. It supports 4K video signals at 60Hz with 4:4:4 YUV chroma subsampling and HDR10.

**VEO-XPT24** allows to extend one 4K video signal up to 40m over a single Cat.5e/6 cable or a Full HD signal up to 70m. With the added features of RS-232 and bidirectional IR, this is the perfect solution for extending a HDMI 1.4 video signal and control signals.

## KEY FEATURES

### VEO-XPT44A:

- Complete HDBaseT extender kit, no settings needed
- Supports up to 4K@60hz, YUV, 4:4:4 resolution
- Transmission distance reaches up to 70 meters when Full HD and 40 meters when 4Ksignal
- HDMI loop out on Transmitter
- Bi-directional IR and RS-232 pass-through
- Bi-directional POH (Receiver powered by TRANSMITTER or vice versa)
- PCM 2.0 Audio de-embedding on TRANSMITTER and RECEIVER
- HDCP2.2/1.4 compliant
- Support for HDR10 and 3D
- ESD protection

### VEO-XPT24:

- Complete extender kit, no settings needed
- Full HD support: 1080p@60Hz
- 4K/UHD support: up to 4096x2160@30Hz (or 60Hz with YUV 4:2:0)
- Transmission distances up to 70 meters under 1080p and 40 meters under 4K
- Bi-directional IR and RS-232 pass-through
- Use single UTP/STP category cable (CAT.5e/6/7) to substitute HDMI cable to achieve long distance transmission
- UTP/STP cable termination follows the standard of IEEE-568B
- POC (RX powered by TX)
- HDCP2.2/1.4 compliant
- Mounting ears supplied

# VEO-XPS43

4K Single Cat. Extender KIT



VEO-XPS43

**VEO-XPS43** is a HDMI extender kit that allows to extend 4K/UHD video signals up to 30m of distance and Full HD signals up to 60m with zero-latency, over a single Cat. 6 cable or higher. It includes EDID management features and IR pass through making it a simple and cost effective solution for professional extension applications.

## KEY FEATURES

- Complete HDMI extender kit for HDMI Audio Video and IR signals extension over single Cat.6 cable or higher
- Supports up to 4K@30Hz video resolution
- Compact design for easy and flexible installation
- Allows for cascading via additional HDMI loop out port
- Supports EDID copying from receiver display or loop out display
- Support Power over cable function (receiver is powered by transmitter)
- HDCP compliant



# WPNETTOUCH

User Control Panels (UCP) Touch Screen Control Device

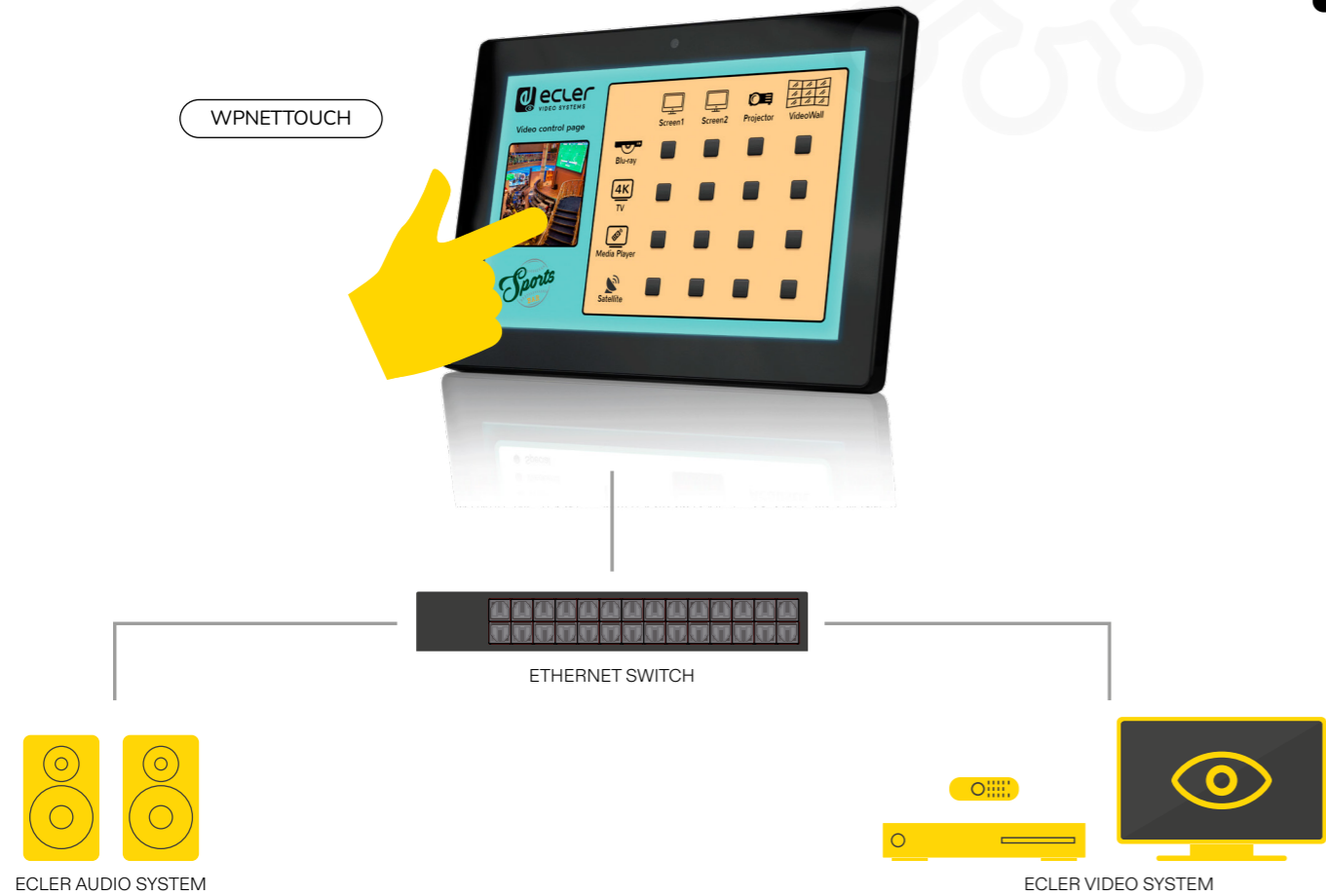

**WPNETTOUCH** is a 10" capacitive TFT tactile panel compatible with all the VEO Series networked products and all the EclerNet native products. When including a WPNETTOUCH in a VEO Series or EclerNet installation it is not necessary to use a computer to manage connected devices. Each WPNETTOUCH unit could be configured to work as a single zone control panel or as a global multi-zone controller. It allows executing customized User Control Panels that are able to control volume, sound source selection, video sources selection, presets recovery, communication via TCP/UDP with external devices, etc. Is fully compatible as a UCP server for third party devices (iOS®, Android®, Windows®, etc.).

**ECLER VIDEO EQUIPMENT CONTROL:** EclerNet Manager allows for the creation of UCP's to control EclerNet native devices, along with other equipment fitted with third party control protocol (TCP/IP, UDP, RS-232 through Ethernet adaptor to RS-232). The UCP can then control Ecler Audio, VEO series Ecler Video and other third party apparatuses by using WPNETTOUCH unit as shown in the image, Ecler UCP APP on Android®/iOS® devices or by using a web browser.

## KEY FEATURES

- 10" Capacitive Touch Panel for fully customized control surfaces
- EclerNet, VEO Series and third party devices remote control compatible
- UCP client/server
- POE and local power supply (multi-plug universal PSU included)
- VESA75 standard mounting accessory included

Digital Control



# ETH232AD

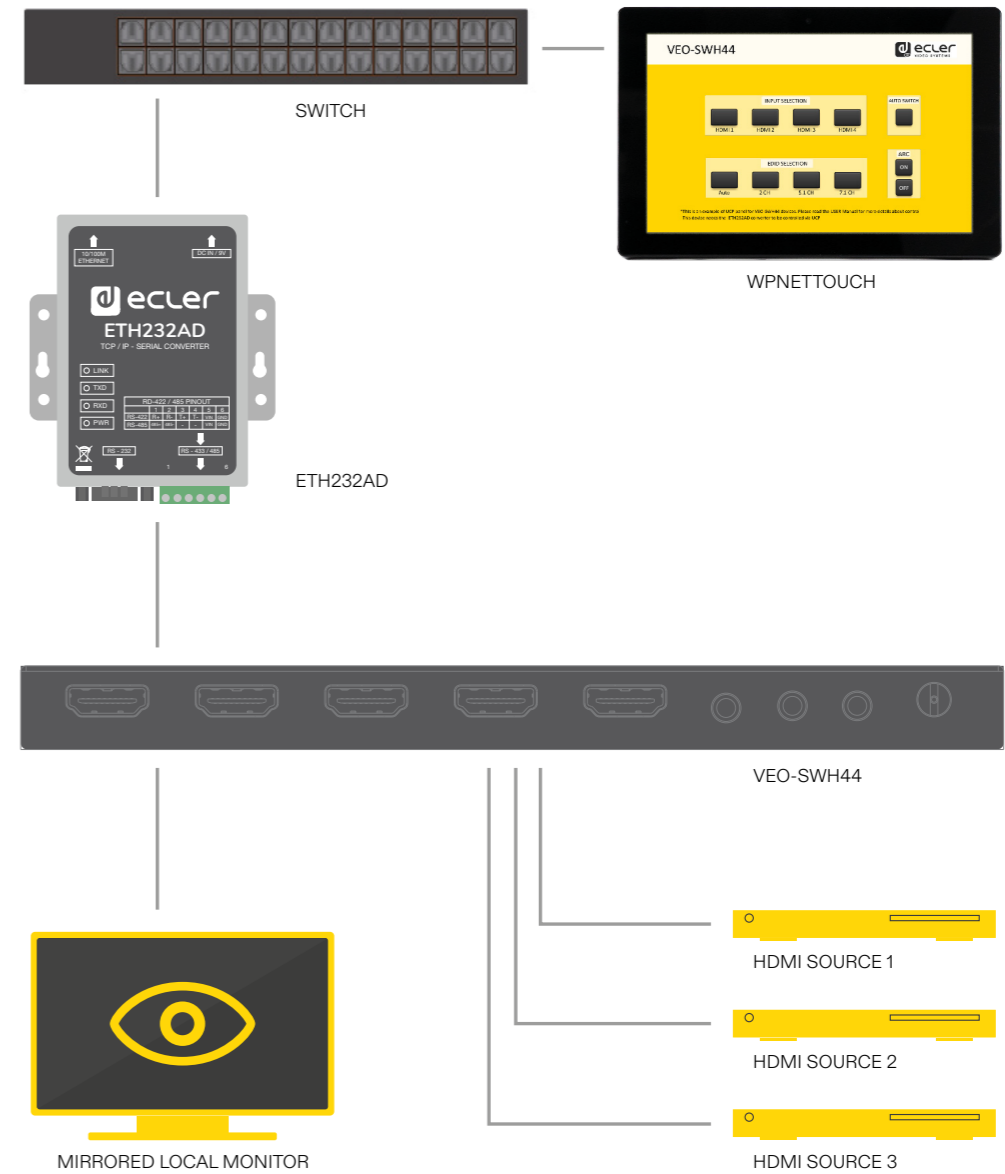
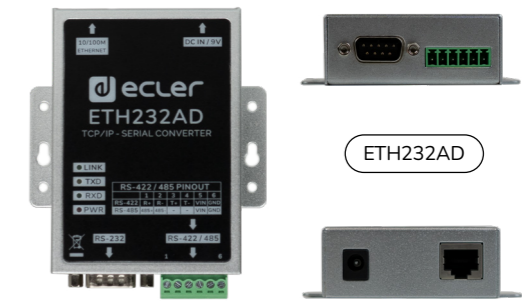

**ETH232AD** is Ecler's new Ethernet-RS232 interface that allows to control devices featuring serial control, through the EclerNet platform using for example a WPNETTOUCH or the multiple control options offered by the platform, such as control via WEB or through an Android®, iOS® devices through the UCP Ecler app. With EclerNet Manager its possible to create customized graphical interfaces to send commands to the ETH232AD, which will be responsible for the translation of the network protocol to the RS-232 protocol. This way, using a WPNETTOUCH you can control audio devices such as a CA series amplifier, video devices such as a VEO series selector or any third party device with RS-232 or RS-485 control.

Digital Control





# VEO-AXS4P / AXS4

HDMI 2.0 Audio De-Embedder 18Gbps



VEO-AXS4P



VEO-AXS4

**VEO-AXS4P** is a professional HDMI audio extractor that allows to de-embed audio from a HDMI signal, including audio from 4K sources. VEO-AXS4P provides uncompressed LPCM analogue stereo signal through RCA and Phoenix balanced output as well as Dolby Digital and DTS multichannel signals through the coaxial S/PDIF digital output.

**VEO-AXS4** allows to extract audio signals from HDMI signals up to 4K. It provides a stereo analog output on RCA connectors or a 5.1 digital output on Toslink connector, selectable through the onboard switch.

## KEY FEATURES

### VEO-AXS2P:

- Audio EDID Settings: Auto/2.0 CH/5.1CH
- Extracts the digital HDMI audio signal from the HDMI input to 2channel analog stereo output or to 5.1 S/PDIF output
- Signal amplification and equalization to extend HDMI input and output ports up to 10 meters (33 feet)
- Supports LPCM, Dolby Digital and DTS
- Supports resolution up to 4K @ 60Hz YUV 4:4:4
- Supports deep color up to 36bit
- Supports sample rate up to 192 KHz and resolutions up to 24 bit
- HDCP2.2/1.4 Compliant
- Supports CEC

### VEO-AXS4:

- Extracts the digital HDMI audio signal from the HDMI input to analog stereo output or to 5.1 S/PDIF output
- Audio EDID Settings: Auto/2.0 CH/5.1CH
- Signal amplification and equalization to extend HDMI input and output ports up to 10 meters (33 feet)
- Supports LPCM, Dolby Digital and DTS
- Supports resolution up to 4K@60Hz YUV4:4:4
- Supports deep color up to 36bit
- Supports samplerate up to 192 kHz and resolutions up to 24 bit
- HDCP2.2/1.4 Compliant
- Supports CEC
- Supports up to 18Gbps video data rate



# VEO-AEXS4 / DACS4

HDMI 2.0 Audio De-Embedder and Embedder 18Gbps / DAC Converter and ARC Extractor



VEO-AEXS4



VEO-DACS4

**VEO-AEXS4** allows to extract and embed audio signals from the HDMI 2.0 input with support up to 4K video. It includes an unbalanced stereo analogue input and output with Euroblock connectors and a digital S/PDIF output with a coaxial connector. Function mode is selectable through the onboard dip-switch.

**VEO-DACS4** allows converting digital audio signals from HDMI ARC and S/PDIF optical or coaxial inputs to a stereo analogue signal. In addition it can be used to convert digital S/PDIF audio coming from the optical input to coaxial and vice versa. It provides a stereo unbalanced analogue output on Euroblock and RCA connectors. Function mode is selectable through the onboard switch.

## KEY FEATURES

### VEO-AEXS4:

- Extracts audio stream from HDMI and converts it to analog stereo or 5.1 digital audio
- Embeds a stereo analogue input into HDMI signal replacing the original sound
- HDMI 2.0 video input supporting resolution up to 4K@60Hz, YUV 4:4:4, 18Gbps
- Supports 3D, HDR
- HDCP2.2/1.4 compliant

### VEO-DACS4:

- HDMI ARC, S/PDIF optical and coaxial inputs
- Includes stereo analogue balanced output on Euroblock connector, stereo analogue unbalanced output on RCA connector and digital S/PDIF output on optical and coaxial connectors
- Frontal switch for input source selection
- Supports DTS, Dolby Digital and PCM up 5.1 channels





# VEO-CAP4U

Professional USB Video Capture



VEO-CAP4U

**VEO-CAP4U** is a plug-n-play HDMI to USB video capture device aimed for online media creators, educational and corporate market etc. that require a professional solution for capturing and streaming their audiovisual content. This product is designed to easily record video and audio from a HDMI source with up to 4K/UHD support, and send it with Full HD video resolution to a PC / MAC over USB 3.0 without the need of an external power supply or additional installation drivers. A balanced line input automatically mixes an external sound source into the main audio stream and it also includes an audio de-embedding feature for extracting the HDMI input's audio data into the stereo unbalanced output.

## KEY FEATURES

- USB audio and video capture from HDMI sources
- HDMI 2.0 pass-through video output with support up to 4K@60Hz, 4:4:4, HDR10
- USB 3.0 capture resolution up to Full HD (1080p@60Hz support)
- UAC, UVC compliant with no driver required
- Compatible with multiple third-party applications on Windows and Mac OS X
- Includes a mono balanced line input and a stereo unbalanced line output
- Powered from USB port, no external power supply required



## Huddle Room AV Installation

Using VEO-CAP4U

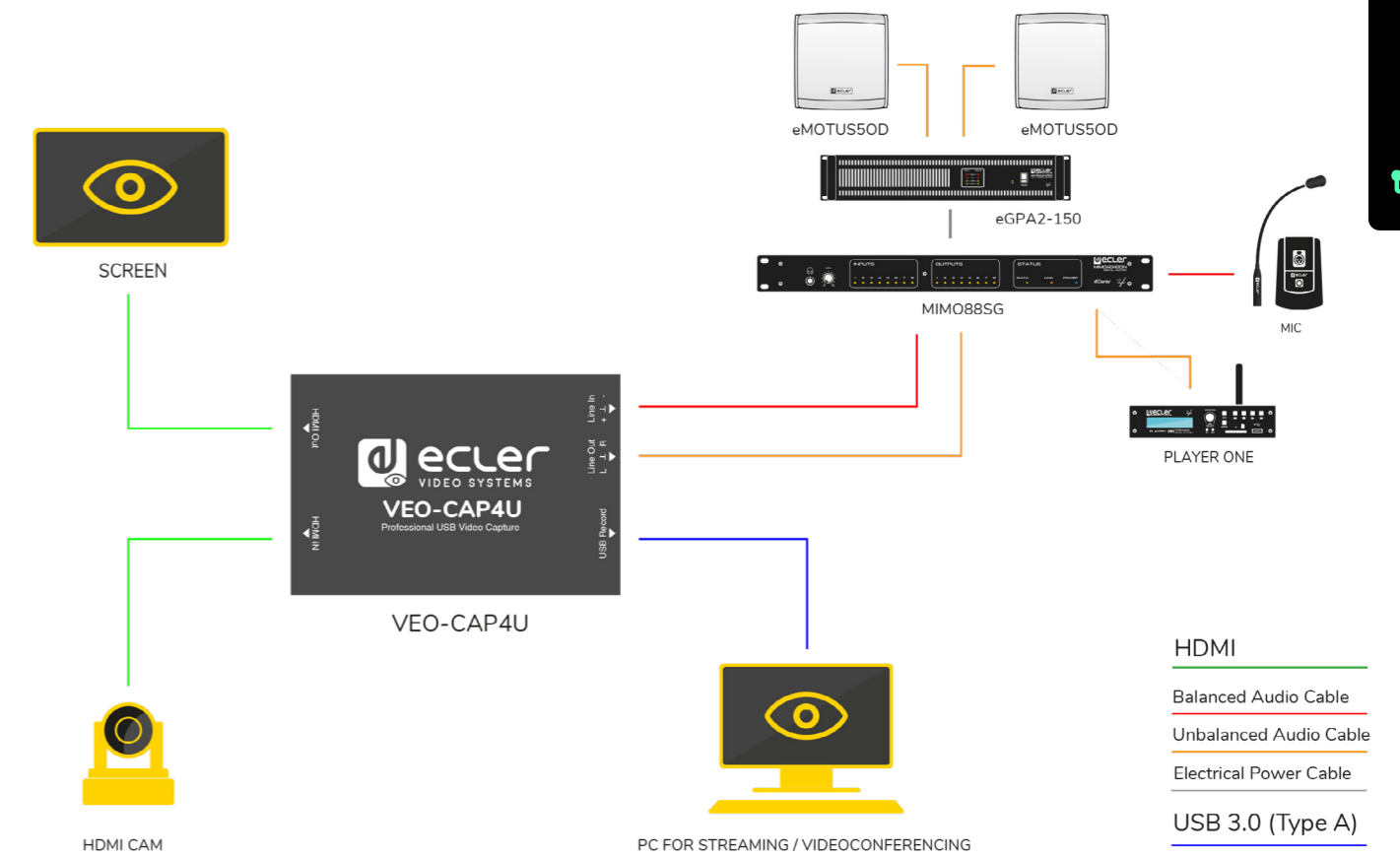

## AV MULTIPURPOSE ROOM

Using VEO-CAP4U & VEO-SWM44

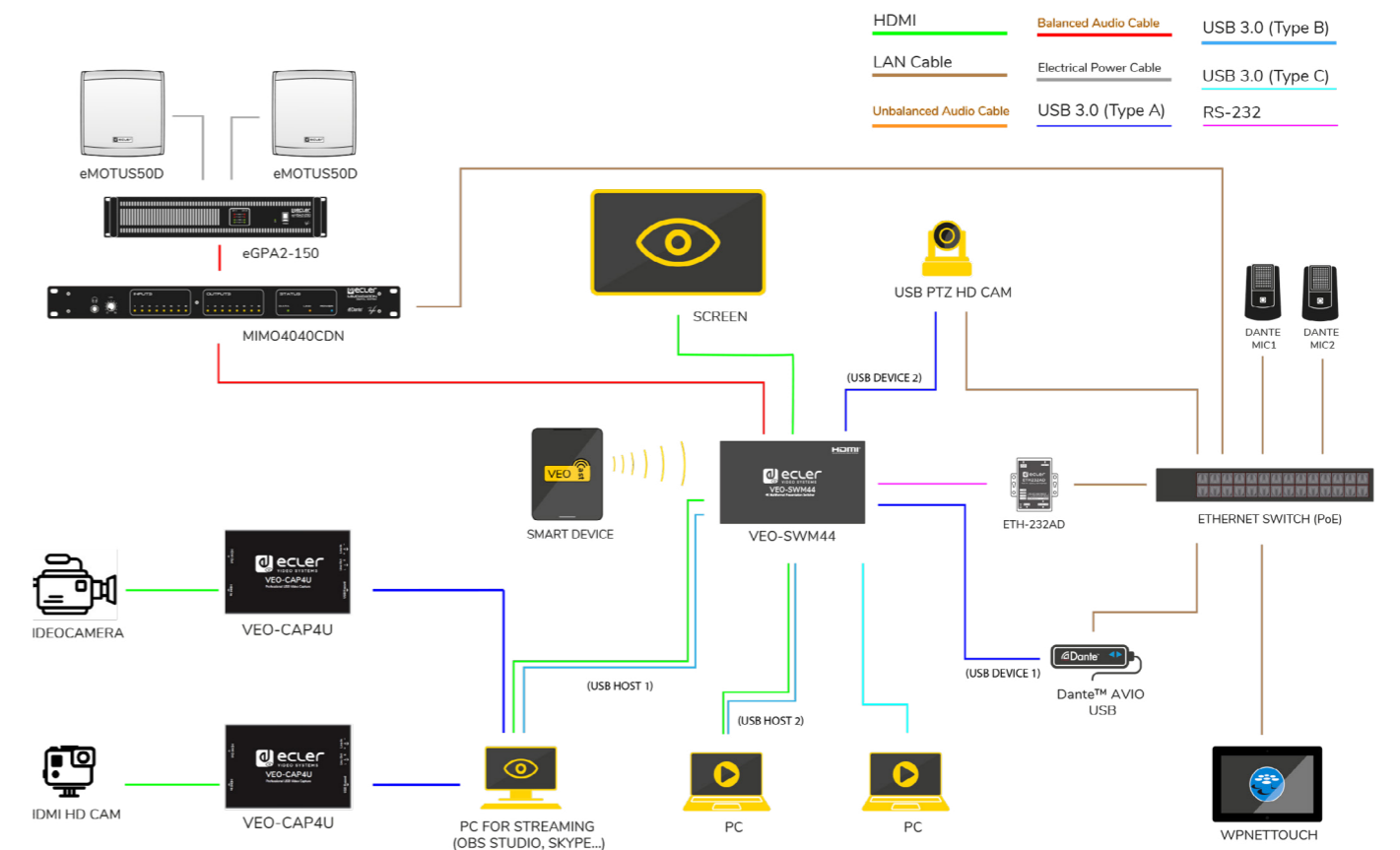



# VEO-CH200-201-202-203 205-208-210

HDMI 2.0 Cable



VEO-CH200-201-202-203-205-208-210

This professional HDMI 2.0 cable family is specially designed to complete Ecler video products line. It includes 7 standard lengths of 0,5m, 1 m, 2 m,3m, 5 m 8m y 10 m. These high quality cables are the perfect solution for professional installations, ensuring reliable and seamless HDMI 2.0 connections up to 18Gbps. All cables support HDMI, Ethernet, Audio and Control (ARC and CEC) signals.

#### KEY FEATURES

- Maximum supported HDMI clock: 600 MHz
- Supported TMDS data rate: 18 Gbit/s
- Maximum supported color depth: 48 bit/px
- Maximum supported resolution: 4096x2160p60
- HEAC (HDMI Ethernet Audio Control)



Accessories



# VEO-RACK19

19" Rack Mounting Shelf



VEO-RACK19

Ecler **VEO-RACK19** is a universal rack mounting support compatible with standard 19" racks. It allows to rack mount multiple devices with different format factor like VEO serie devices.

#### KEY FEATURES

- Universal shelf for rack mounting all VEO products
- Products can be mounted in the front or in the rear side of the shelf
- Includes 12 x M3 screws with nuts and Dual Lock™ tape for devices not provided of mounting ears
- Central holes for cable ties

Accessories





# VEO Specifications Table



	SWITCHERS			MATRIXES	
	VEO-SWH44	VEO-SWM44	VEO-SWC44	VEO-MXH44D	VEO-MXH88D
<b>INPUTS</b>					
HDMI	4	2	-	4	8
VGA	-	-	-	-	-
DisplayPort	-	-	-	-	-
USB-C Video	-	1	-	-	-
HDBaseT	-	Yes	-	-	-
H.264 Streaming	-	-	-	-	-
Fiber Port	-	-	-	-	-
USB Control	-	Yes	Yes	-	-
RS232	1	1	1	1	1
IR	1	-	-	1	1
SPDIF	-	-	-	-	-
Stereo Analogue Audio	-	-	-	-	8
Full HD Support	Yes	Yes	Yes	Yes	Yes
4K@30 Hz Support	Yes	-	-	Yes	Yes
4K@60 Hz Support	Yes	-	-	Yes	Yes
<b>OUTPUTS</b>					
HDMI	1	1	1	4	8
HDBaseT	-	-	-	-	-
H.264 Streaming	-	-	-	-	-
Fiber Port	-	-	-	-	-
USB Control	-	Yes	Yes	-	-
RS232	1	-	-	1	1
IR	-	-	-	1	1
SPDIF	Optical	-	-	4 (Coaxial)	8 (Coaxial)
Stereo Analogue Audio	1	1	1	8	8
Full HD Support	Yes	Yes	Yes	Yes	Yes
4K@30 Hz Support	Yes	Yes	Yes	Yes	Yes
4K@60 Hz Support	Yes	Yes	Yes	Yes	Yes
<b>FEATURES</b>					
Videowall	-	-	-	-	-
Video Scaler	-	-	-	-	-
EDID Management	Yes	Yes	Yes	Yes	Yes
HDR	HDR10 / Dolby Vision	HDR10 / Dolby Vision	-	HDR10 / Dolby Vision	HDR10 / Dolby Vision
HDCP Support	Yes	Yes	-	Yes	Yes
USB AV Capture	-	-	-	-	-
CEC	Yes	Yes	-	Yes	-
Multichannel Audio	Dolby Atmos / DTS X	Dolby Atmos / DTS X	Dolby Atmos / DTS X	Dolby Atmos / DTS X	Dolby Atmos / DTS X
Audio Embedding	-	-	-	-	LPCM 2.0
Audio Extraction	LPCM 2.0, SPDIF	LPCM 2.0	LPCM 2.0	LPCM 2.0, SPDIF	LPCM 2.0
ARC	Yes	-	-	-	-
RS232 Extension	-	-	-	-	-
IR Extension	-	-	-	Yes	-
Audio Extension	-	-	-	-	-
KVM Extension	-	Yes	Yes	-	-
Cat.6a/7 Extension	-	-	-	-	-
PoE, PoH, PoC	-	-	Yes	-	-
USB Power	-	-	-	-	-
<b>CONTROL OPTIONS</b>					
Web	-	Yes	Yes	Yes	Yes
Telnet	-	-	-	Yes	Yes
RS232	Yes	Yes	Yes	Yes	Yes
IR	Yes	-	-	Yes	Yes
GPI	-	-	-	-	-
EclerNet Manager	Integrable (ETH232AD)	Integrable (ETH232AD)	Integrable	Integrable	Integrable
<b>DIMENSIONS</b>					
Dimensions (HxLxW)	12x180x85mm / 0,47"x7,09"x1,77"	44x220x150mm / 1,76"x8,66"x5,90"	41x220x120mm / 1,61"x8,66"x4,72"	34x216x128mm / 1,34"x8,50"x5,04"	44x482x220mm / 1,73"x18,97"x8,66"
Weight	300g / 0,66 lb	1250g / 2,75 lb	1000g / 2,20 lb	470g / 1,04 lb	2800g / 6,17 lb

	SPLITTERS			VIDEO DISTRIBUTION OVER IP			
	VEO-SPH48	VEO-SPH44	VEO-SPH42	VEO-XT11CG2	VEO-XR11CG2	VEO-XTI2L	VEO-XRI2L
<b>INPUTS</b>							
HDMI	1	1	1	1	-	1	-
VGA	-	-	-	-	-	-	-
DisplayPort	-	-	-	-	-	-	-
USB-C Video	-	-	-	-	-	-	-
HDBaseT	-	-	-	-	-	-	-
H.264 Streaming	-	-	-	-	Yes	-	-
Fiber Port	-	-	-	-	-	-	1
USB Control	-	-	-	-	-	Yes	Yes
RS232	-	-	-	1	1	1	1
IR	-	-	-	-	-	2	2
SPDIF	-	-	-	-	-	-	-
Stereo Analogue Audio	-	-	-	1	1	1	-
Full HD Support	Yes	Yes	Yes	Yes	Yes	Yes	Yes
4K@30 Hz Support	Yes	Yes	Yes	-	-	Yes	Yes
4K@60 Hz Support	Yes	Yes	Yes	-	-	-	-
<b>OUTPUTS</b>							
HDMI	8	4	2	-	1	-	1
HDBaseT	-	-	-	-	-	-	-
H.264 Streaming	-	-	-	-	Yes	-	-
Fiber Port	-	-	-	-	-	1	-
USB Control	-	-	-	-	-	Yes	Yes
RS232	-	-	-	1	1	1	1
IR	-	-	-	-	-	1	1
SPDIF	-	-	-	-	-	-	Optical
Stereo Analogue Audio	-	-	-	1	1	-	1
Full HD Support	Yes	Yes	Yes	Yes	Yes	Yes	Yes
4K@30 Hz Support	Yes	Yes	Yes	-	-	Yes	Yes
4K@60 Hz Support	Yes	Yes	Yes	-	-	-	-
<b>FEATURES</b>							
Videowall	-	-	-	Yes	Yes	Yes	Yes
Video Scaler	-	-	-	Downscaling	Downscaling	Yes	Yes
EDID Management	Yes	Yes	Yes	-	-	Yes	Yes
HDR	HDR10 / Dolby Vision	HDR10 / Dolby Vision	HDR10 / Dolby Vision	-	-	-	-
HDCP Support	Yes	Yes	Yes	Yes	Yes	Yes	Yes
USB AV Capture	-	-	-	-	-	-	-
CEC	-	-	-	-	-	-	-
Multichannel Audio	Dolby Atmos / DTS X	Dolby Atmos / DTS X	Dolby Atmos / DTS X	Dolby True HD / DTS Master Audio	Dolby True HD / DTS Master Audio	Dolby True HD / DTS Master Audio	Dolby True HD / DTS Master Audio
Audio Embedding	-	-	-	LPCM 2.0	-	LPCM 2.0	-
Audio Extraction	-	-	-	LPCM 2.0	LPCM 2.0	-	LPCM 2.0, SPDIF
ARC	-	-	-	-	-	-	-
RS232 Extension	-	-	-	Yes	Yes	Yes	Yes
IR Extension	-	-	-	-	-	Yes	Yes
Audio Extension	-	-	-	-	-	Yes	Yes
KVM Extension	-	-	-	-	-	Yes	Yes
Cat.6a/7 Extension	-	-	-	120m@FullHD	120m@FullHD	100m/60Km@4K30	100m/60Km@4K30
PoE, PoH, PoC	-	-	-	Yes	Yes	Yes	Yes
USB Power	-	-	Yes	-	-	-	-
<b>CONTROL OPTIONS</b>							
Web	-	-	-	Yes	Yes	Yes	Yes
Telnet	-	-	-	Yes	Yes	Yes	Yes
RS232	-	-	-	-	-	-	-
IR	-	-	-	-	-	Yes	Yes
GPI	-	-	-	-	-	-	-
EclerNet Manager	-	-	-	Integrable	Integrable	Compatible	Compatible
<b>DIMENSIONS</b>							
Dimensions (HxLxW)	17x248x110mm / 0,67"x9,76"x4,33"	17x150x65mm / 0,67"x5,90"x2,56"	15x94x61mm / 0,59"x3,70"x2,40"	21,5x95x120mm / 0,85"x3,74"x4,72"	21,5x95x120mm / 0,85"x3,74"x4,72"	30x160x104mm / 1,18"x6,30"x4,09"	30x160x104mm / 1,18"x6,30"x4,09"
Weight	610g / 1,34 lb	245g / 0,54 lb	120g / 0,26 lb	74g / 0,16 lb	74g / 0,16 lb	470g / 1,04 lb	470g / 1,04 lb







# Alphabetical Index of Products

# Stay tuned



Newsletter



Would you like to receive news about our products and solutions?  
Then, sign up for our Newsletter





**ecler**

**ECLER PROAUDIO, S.L.**

08040 Barcelona, SPAIN

T. (+34) 932 238 400

[www.ecler.com](http://www.ecler.com)

[information@ecler.com](mailto:information@ecler.com)

**NEEC AUDIO DEUTSCHLAND GMBH**

28359 Bremen, GERMANY

T. (+49) 0421 - 98976170

[www.neec-audio.de](http://www.neec-audio.de)

[info@neec-audio.de](mailto:info@neec-audio.de)



[www.ecler.com](http://www.ecler.com)



All product characteristics are subject to variation due to production tolerances. ECLER ° NEEC AUDIO BARCELONA S.L. reserves the right to make changes or improvements in the design or manufacturing that may affect these product specifications.